

ACCESSOIRES / ACCESSORIES / ZUBEHÖR / TOEBEHOREN

POUR VENTOUSES EN APPLIQUE SERIES EF300 & EF550
 FOR SURFACE ELECTROMAGNETIC LOCKS EF300 & EF550 SERIES
 FÜR aP- FLÄCHENHAFTMAGNETE EF300 & EF550
 VOOR VERGRENDLMAGNETEN TE OPBOUWEN REEKS EF300 & EF550

EF300SCP

NOTICE DE MONTAGE MOUNTING INSTRUCTIONS
 MONTAGEANLEITUNG HANDLEIDING

Support de pose pour contreplaque
 Mounting set for armature plate
 Montageset für Gegenplatte
 Onderstelling voor tegenplaat



	DIN 7982 ST 4,8 x 25	ISO 7046 M8 x 20
Composition du kit : Kit composed of: Verpackungsinhalt: Kit samenstelling:		
 <div style="text-align: right; margin-right: 50px;"> 1 x </div> <p style="text-align: right; margin-right: 50px;">EF300SCP</p> <p style="text-align: right; margin-right: 50px;"><i>pour - for - passend zur - voor :</i> <i>série - series - Serie - reeks EF300/EF300-2</i></p>	6x	1 x

EF300SCP

Dimensions
Abmessungen
Afmetingen

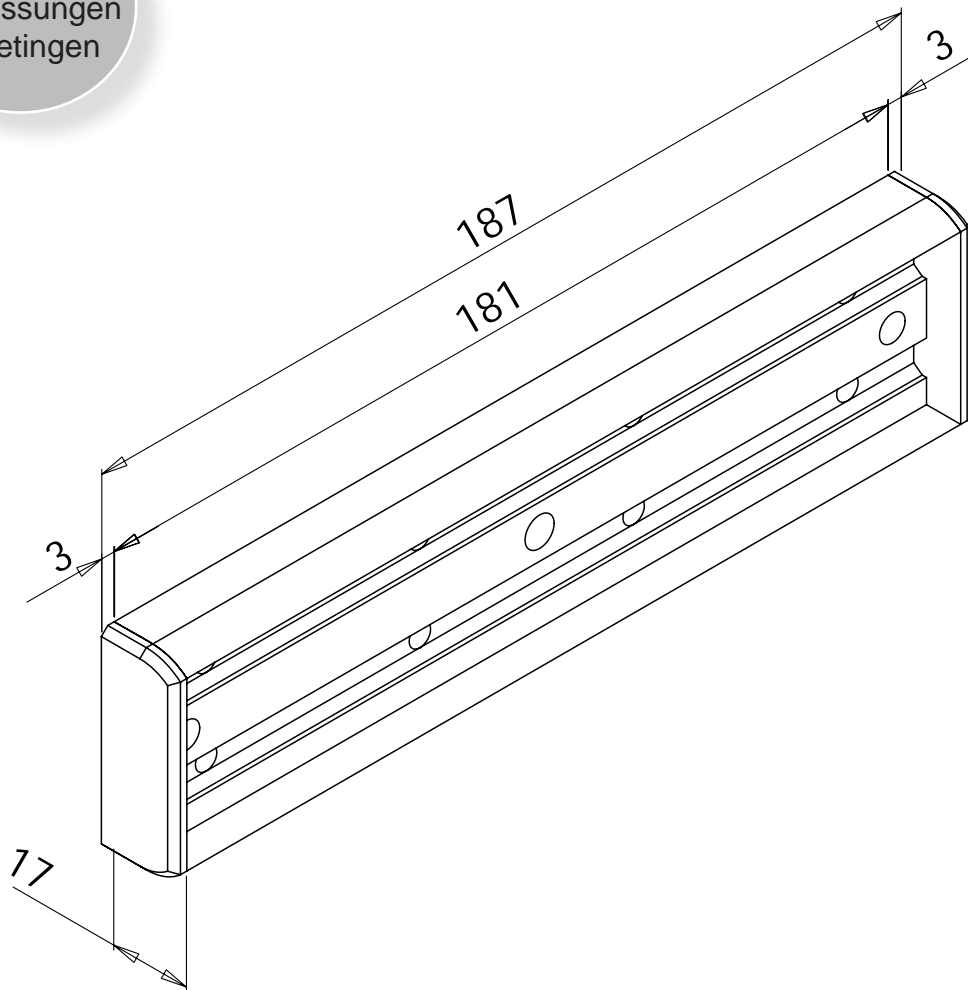

EF300SCP



**SUR PORTE POUSSANTE SIMPLE
ON SINGLE PUSH-DOOR
AUF AUSWÄRTS ÖFFNENDE TÜREN
OP EENVOUDIGE DEUR OM TE DUWEN**

MONTAGE
MOUNTING

1 x { EF300
EF300SCP

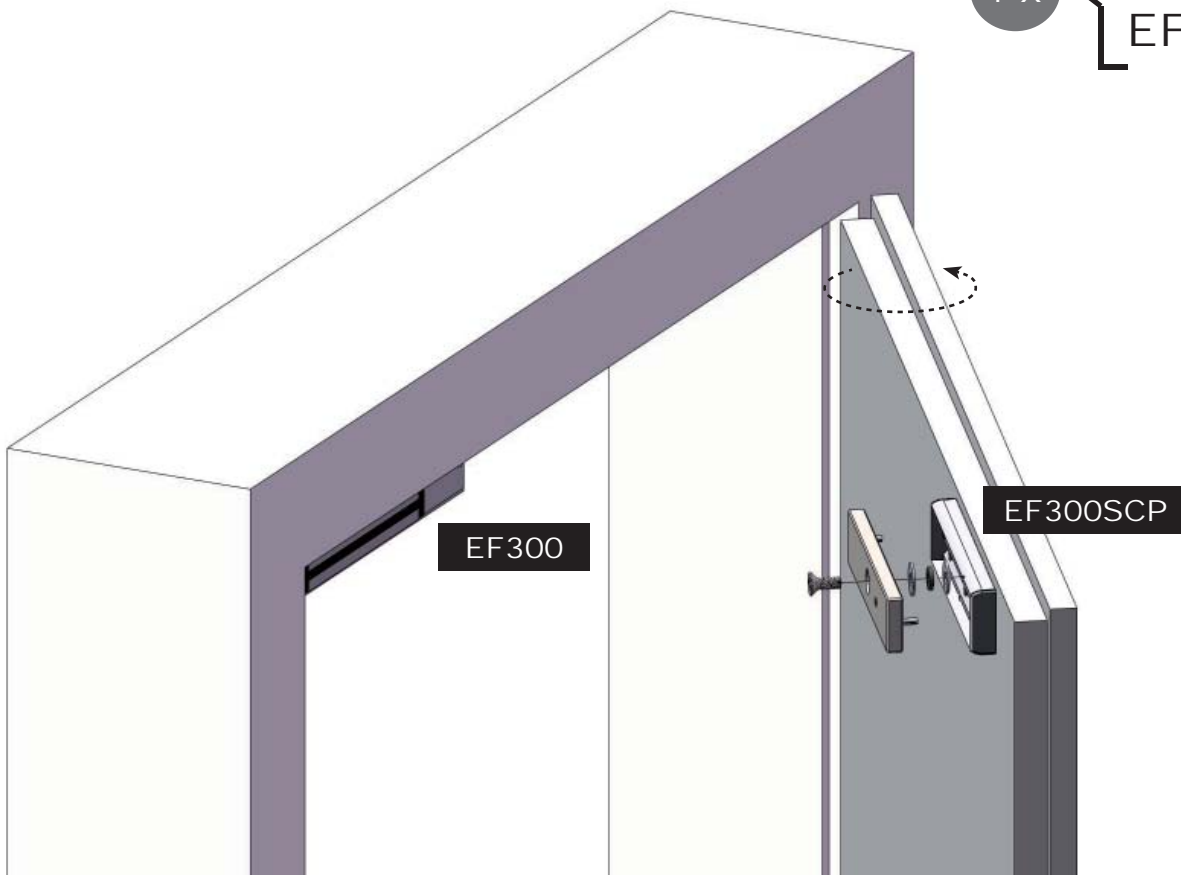

*En se plaçant côté ventouse
Standing on magnet's side
Magnet sichtbar vom Standort
Standpunt magneetzijde*

SEWOSY®

F-67170 BERNOLSHEIM Tél. : +33 (0)3.88.59.32.20 Fax : +33 (0)3.88.59.32.19 info@sewosy.com www.sewosy.com
SEWOSY se réserve le droit de modifier les caractéristiques techniques et tarifaires, la forme et les dimensions de tous les modèles, sans préavis
SEWOSY reserve the right to go ahead with any modifications of models or features or prices without forewarning
Änderungen des Lieferprogrammes durch technische Weiterentwicklungen sowie Preisänderungen behalten wir uns vor.
SEWOSY behoudt zich het recht akkoord te gaan met veranderingen van de prijzen of de modellen zonder vooraf te waarschuwen



NOTES
NOTIZEN
NOTA

