



THE CAR BOOK 4

# THE CAR BOOK 4

## EN

Silca Library	VI
Glossary	VIII
Key identification	IX
Technical information	X
Uses	XII
Transponder information	XIII
Nationality	XIII
Key types	XIV

Vehicles guide legend	3
Car keys guide	8
Motorcycle keys guide	378
Truck keys guide	418
Vehicle related keys	427
General index	438

## IT

Libreria Silca	VI
Terminologia	VIII
Identificazione chiave	IX
Informazioni tecniche	X
Utilizzi	XII
Informazioni transponder	XIII
Nazionalità	XIII
Tipi di chiave	XIV

Legenda guida veicoli	3
Guida chiavi auto	8
Guida chiavi moto	378
Guida chiavi camion	418
Chiavi veicoli - utilizzi vari	427
Indice generale	438

## DE

Datenarchiv Silca	VI
Terminologie	VIII
Schlüsselidentifikation	IX
Technische Auskünfte	X
Verwendungen	XII
Transponder Auskünfte	XIII
Nationalität	XIII
Schlüsseltypen	XIV

Autoschlüssel Erläuterung	3
Marktführer für Autoschlüssel	8
Marktführer für Motorräderschlüssel	378
Marktführer für LKW Schlüssel	418
Fahrzeugschlüssel - verschiedene Verwendungen	427
Generalverzeichnis	438

**FR**

Bibliothèque Silca	VI
Terminologie	VIII
Identification clé	IX
Informations techniques	X
Utilisations	XII
Informations transpondeur	XIII
Nationalité	XIII
Types de clé	XIV

Légende guide véhicules	3
Guide clés pour voitures	8
Guide clés pour motocyclettes	378
Guide clés pour camions	418
Clés véhicules pour différentes utilisations	427
Index général	438

**ES**

Librería Silca	VI
Terminología	VIII
Identificación de la llave	IX
Informaciones técnicas	X
Utilizaciones	XII
Informaciones transponder	XIII
Nacionalidad	XIII
Tipos de llave	XIV

Leyenda guía para vehículos	3
Guía llaves para coches	8
Guía llaves para motocicletas	378
Guía llaves para camiones	418
Llaves vehículos para diferentes utilizaciones	427
Índice general	438

**PT**

Livraria Silca	VI
Terminologia	VIII
Identificação de uma chave	IX
Informações técnicas	X
Utilizações	XII
Informações transponder	XIII
Nacionalidade	XIII
Tipos de chave	XIV

Legenda guia para veículos	3
Guia chaves para carros	8
Guia chaves para motocicletas	378
Guia chaves para camiões	418
Chaves veículos para utilizações várias	427
Índice geral	438





## EN

**You have chosen technology and innovation. You have chosen Silca. Thank you.**

Our keys are produced exclusively with selected and certified raw materials.

Every single work phase is also controlled and carried out with highly advanced machinery. Severe product quality control certifies dimensions, aesthetics and respond to the original product and/or to the customers specific requests. Using the SPC (Statistic Process Control) control procedure to every single working phase we guarantee the quality our customers expect from us.

## IT

**Avete scelto tecnologia e innovazione. Avete scelto Silca. Grazie.**

Le nostre chiavi vengono prodotte esclusivamente con materie prime selezionate e certificate.

Ogni singola fase di lavorazione, effettuata con macchinari all'avanguardia e attrezzature di progettazione esclusiva, viene certificata in base a severi controlli su tutte le variabili qualitative di prodotto: dimensioni, estetica, perfetta rispondenza del materiale e del prodotto alle specifiche dell'originale o del cliente. L'adozione di procedure di controllo SPC (Statistic Process Control) ad ogni fase di produzione garantisce inoltre la qualità che i nostri clienti si aspettano da noi.

## DE

**Sie haben Technologie und Innovation gewählt. Sie haben Silca gewählt. Danke.**

Unsere Schlüssel sind nur mit gewählten und zertifizierten Rohmaterialien hergestellt.

Jede einzelne Arbeitsphase, die mit modernen Maschinen und exklusiven Entwicklungs- und Projektierungsmittel gemacht wurde, ist durch strenge Kontrolle zertifiziert. Masse, Ästhetik, Produkte und Materialien sind nach den technischen Spezifikation garantiert. Die SPC (Statistic Process Control) Verfahren versichern die Kontrolle auf jede einzelne Arbeitsphase und die Qualität, die unsere Kunden von uns erwarten.

## GTI - GLASS TRANSPONDER INNOVATION



Silca shakes up vehicle keys duplication thanks to the first worldwide multifunctional glass transponder.

Silca apre una nuova era nella duplicazione chiavi veicolo grazie al primo transponder multifunzione in vetro.

Silca öffnet den Weg in ein neues Zeitalter für das Kopieren von Fahrzeugschlüsseln dank des ersten multifunktionalen Transponders aus Glas.

Silca ouvre une nouvelle ère dans la reproduction de clés pour véhicules grâce au premier transpondeur multifonction en verre.

Silca abre una nueva era en la duplicación de las llaves vehículo gracias al primer transponder multifunción de cristal.

A Silca abre uma nova era na duplicação das chaves para veículo, graças ao primeiro transponder multi-função em vidro.





**GTI THE 1<sup>ST</sup> WORLDWIDE**

**FR**

**Vous avez choisi technologie et innovation. Vous avez choisi Silca. Merci.**

Nos clés sont produites exclusivement sur la base de matières premières sélectionnées et certifiées.

Chaque phase du processus de fabrication de nos produits est effectuée au travers de machines d'avant-garde et d'outillages exclusifs et, après des contrôles sévères de toutes les variables qualitatives du produit, comme dimensions, aspect esthétique, correspondance du matériel et du produit-même aux caractéristiques spécifiques originales et/ou demandées par le client, est ensuite certifiée. Le choix d'adopter un processus de contrôle SPC (Statistic Process Control) pour chaque phase de fabrication garantit la qualité que nos clients attendent de nous.

**ES**

**Usted ha elegido tecnología y innovación. Usted ha elegido Silca. Gracias.**

Nuestras llaves se fabrican exclusivamente con materia prima seleccionada y certificada.

Cada fase de fabricación, efectuada con maquinaria de última generación y herramientas de proyecto exclusivo, es certificada en base a severos controles de todas las variables cualitativas del producto: tamaño, estética, perfecta correspondencia del material con el producto original o la solicitud del cliente. La adopción de procedimientos de control SPC (Statistic Process Control) en cada fase de producción garantiza además la calidad que nuestros clientes esperan de nosotros.

**PT**

**Você escolheu tecnologia e inovação. Você escolheu Silca. Obrigado.**

As nossas chaves são fabricadas exclusivamente com matérias-primas seleccionadas e certificadas.

Cada fase do fabrico, realizada com máquinas de vanguarda e equipamento de projecto exclusivo, é certificada com base em rigorosos controlos de todas as variáveis qualitativas do produto: dimensões, estética, correspondência perfeita do material e do produto com as especificações do original ou do cliente. A adopção de procedimentos de controlo SPC (Statistic Process Control) em cada fase da produção também garante a qualidade que os nossos clientes esperam de nós.

## SILCA: FIRST WORLDWIDE FOR AUTHENTIC TRANSPONDER KEYS INNOVATION

GTI is compatible with Silca's latest transponder key ranges, guarantees a constantly updated automotive keys service and is the ideal solution in case of original key loss.

GTI è compatibile con le chiavi transponder Silca, garantisce un servizio chiavi automotive sempre aggiornato ed è la soluzione ideale in caso di perdita della chiave originale.

GTI ist kompatibel mit den neuen Silca Transponderschlüssel, versichert einen hochmodernen Fahrzeugschlüsseldienst und ist die ideale Lösung, wenn der Originalschlüssel verloren wird.

GTI est compatible avec les nouvelles clés transpondeur Silca, garantit d'être à l'avant-garde dans votre service clés pour véhicules et est la solution parfaite en cas de perte de la clé originale.

GTI es compatible con las nuevas llaves transponder Silca, asegura un servicio llaves vehículo a la vanguardia y es la solución perfecta en caso de que se pierda la llave original.

GTI é compatível com as novas chaves transponder Silca, assegura um serviço chaves para veículos na vanguarda e a solução perfeita em caso de perda da chave original.

# THE CAR BOOK 4

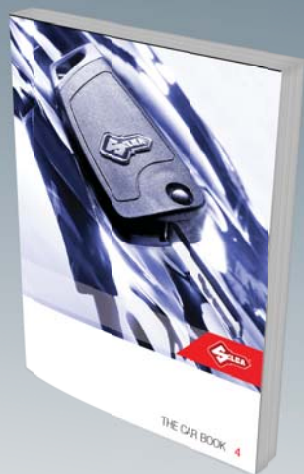

THE CAR BOOK 4 CATALOGUE

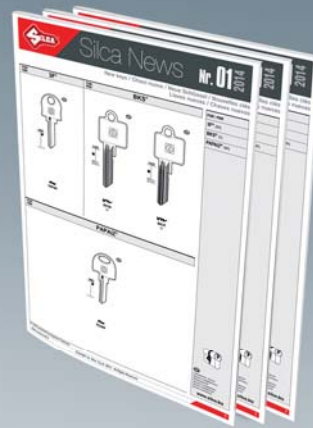

MONTHLY SILCA NEWS BULLETINS

EN

## SILCA LIBRARY

This Catalogue updates and completes the information regarding all the vehicle keys produced by Silca. If you would like to keep your catalogues always updated, visit [www.silca.biz](http://www.silca.biz). Every month you can find out what new keys have been produced consulting and printing the "Silca News" Bulletins.

## ELECTRONIC KEY CATALOGUE

Silca also makes its electronic key catalogue available to you, also on your smartphone. The Silca electronic catalogue will be updated in real time with all the new keys making it the ideal assistant for all office activities, the management of stock references, automatic creation of orders, printing packing lists and much more.

IT

## LIBRERIA SILCA

Questo catalogo aggiorna e completa le informazioni relative a tutte le chiavi veicolo prodotte da Silca. Se desiderate mantenere sempre aggiornati i vostri cataloghi, collegatevi al sito [www.silca.biz](http://www.silca.biz). Ogni mese saprete quali nuove chiavi sono state prodotte consultando e stampando i Bollettini "Silca News".

## CATALOGO CHIAVI ELETTRONICO

Silca mette a vostra disposizione il catalogo elettronico chiavi, consultabile anche tramite smartphone. Il catalogo elettronico Silca è aggiornato in tempo reale con tutte le ultime novità ed è l'assistente ideale per le attività di ufficio, per la gestione delle referenze a stock, per la creazione automatica di ordini, la stampa di bindelli e molto altro ancora.

DE

## DATENARCHIV SILCA

Mit Hilfe dieses Informationswerkzeuges erhalten Sie aktualisierte und vervollständigte Informationen in Bezug auf alle von Silca produzierten Fahrzeugschlüssel. Damit Ihre Kataloge immer auf dem neuesten Stand sind, können Sie Neuheiten auf der Webseite [www.silca.de](http://www.silca.de) abrufen. Jeden Monat erfahren Sie, welche neuen Schlüssel produziert werden, wenn Sie den monatlichen Newsletter "Silca News" aufrufen und ausdrucken.

## ELEKTRONISCHER SCHLÜSELKATALOG

Silca stellt Ihnen einen elektronischen Schlüsselkatalog zur Verfügung, der auch über das Smartphone verfügbar ist. Damit werden Sie in Echtzeit über alle Neuheiten auf dem Laufenden gehalten. Der elektronische Katalog von Silca ist das ideale Hilfsmittel für die Arbeit im Büro, die Verwaltung des Lagerbestands, die automatische Erstellung von Bestellungen, den Ausdruck von Verpackungslabels und vieles andere mehr.

## WWW.SILCA.BIZ

To update The Car Book 4 catalogue, visit our website and download the "Silca News" Bulletins, issued monthly.  
Per aggiornare il catalogo The Car Book 4, visitate il nostro sito e scaricate i Bollettini "Silca News", pubblicati mensilmente.  
Um den Katalog The Car Book 4 zu aktualisieren, rufen Sie unsere Webseite auf und laden Sie die Newsletter "Silca News" herunter, die monatlich veröffentlicht werden.  
Pour mettre le catalogue The Car Book 4 à jour, visitez notre site et téléchargez les Bulletins "Silca News", mis à jour une fois par mois.  
Para actualizar el catálogo The Car Book 4, consulte nuestro sitio web y descargue los Boletines "Silca News", actualizados mensualmente.  
Para atualizar o catálogo The Car Book 4 consulte nosso site e baixe os Boletins "Silca News", atualizados mensalmente.



SILCA ELECTRONIC KEY CATALOGUE



SILCA EKC WEB MOBILE

FR

## BIBLIOTHÈQUE SILCA

Ce catalogue actualise et complète les informations fournies sur toutes les clés pour véhicules produites par Silca.

Si vous souhaitez que vos catalogues soient toujours à jour, visitez notre site Internet [www.silca.biz](http://www.silca.biz). Tous les mois, vous serez informés sur les nouvelles clés produites en consultant et en imprimant les Bulletins "Silca News".

## CATALOGUE DE CLÉS ÉLECTRONIQUES

Silca met à votre disposition un catalogue électronique clés, qui est disponible aussi sur votre Smartphone.

Le catalogue électronique Silca, actualisé en temps réel avec toutes les dernières nouveautés, est l'assistant idéal des activités administratives comme la gestion des références en stock, mais également pour la création automatique des commandes, l'impression des news et bien plus encore.

ES

## LIBRERÍA SILCA

Este catálogo actualiza y completa la información relativa a todas las llaves para vehículos fabricadas por Silca.

Si desea que sus catálogos siempre estén actualizados, conéctese al sitio [www.silca.biz](http://www.silca.biz). Cada mes le será posible conocer qué llaves nuevas se han fabricado consultando e imprimiendo los Boletines "Silca News".

## CATÁLOGO DE LLAVES ELECTRÓNICO

Silca pone a su disposición un catálogo electrónico llaves, disponible también en su smartphone.

El catálogo electrónico Silca, actualizado en tiempo real sobre todas las novedades, es el asistente ideal para las actividades de la oficina, gestionar las referencias en stock, crear automáticamente los pedidos, imprimir etiquetas y mucho más.

PT

## LIVRARIA SILCA

Este catálogo atualiza e completa as informações sobre todas as chaves para veículos produzidas pela Silca.

Desejando manter os catálogos sempre atualizados, entre no nosso site [www.silca.biz](http://www.silca.biz). Cada mês você saberá quais são as novas chaves produzidas consultando e imprimindo os Boletins "Silca News".

## CATÁLOGO ELETRÔNICO CHAVES

Silca coloca à sua disposição um catálogo eletrônico chaves, também disponível em seu smartphone.

O catálogo eletrônico Silca, atualizado em tempo real com todas as novidades, é o assistente ideal para o escritório, para a gestão das referências de estoque, para a criação automática de pedidos, imprimir etiquetas e muito mais.

## EKC.SILCA.BIZ - ELECTRONIC KEY CATALOGUE

EKC contains all of the new keys produced by Silca and is always updated.  
 EKC contiene tutte le nuove chiavi prodotte da Silca ed è sempre aggiornato.  
 EKC, der elektronische Schlüsselkatalog, enthält alle neue Silca Schlüssel und wird immer aktualisiert.  
 EKC contient toutes les nouvelles clés produites par Silca et est toujours mis à jour.  
 EKC contiene todas las nuevas llaves producidas por Silca y se actualiza siempre.  
 EKC contém todas as novas chaves produzidas pela Silca e é atualizado sempre.





## GLOSSARY - TERMINOLOGIA - TERMINOLOGIE - TERMINOLOGIE - TERMINOLOGÍA - TERMINOLOGIA

Vehicle keys guide (page 8) • Guida chiavi veicolo (pag. 8)  
 Führer für Fahrzeugschlüssel (Seite 8) • Guide clés pour véhicules (page 8)  
 Guía llaves para vehículos (pág. 8) • Guia chaves para veículos (pág. 8)

Vehicle related keys (page 427) • Chiavi veicoli - Utilizzi vari (pag. 427)  
 Fahrzeugschlüssel für verschiedene Verwendungen (Seite 427) • Clés véhicules pour différentes utilisations (page 427) • Llaves vehículos para diferentes utilizaciones (pág. 427) • Chaves veículos para utilizações várias (pág. 427)

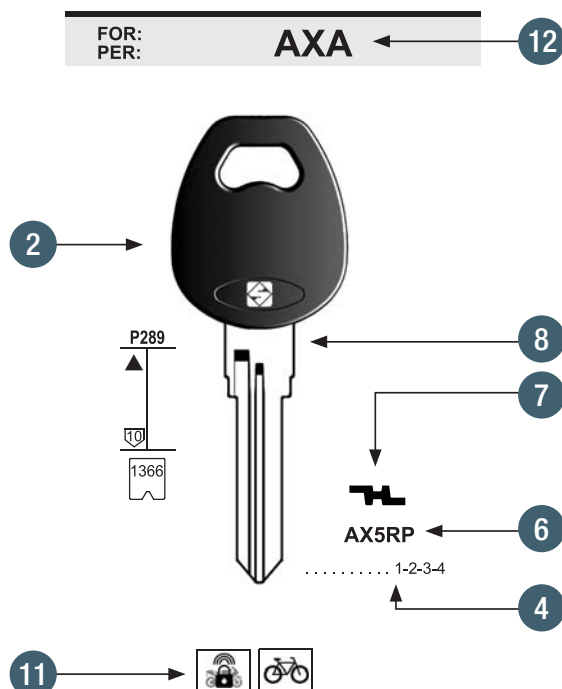
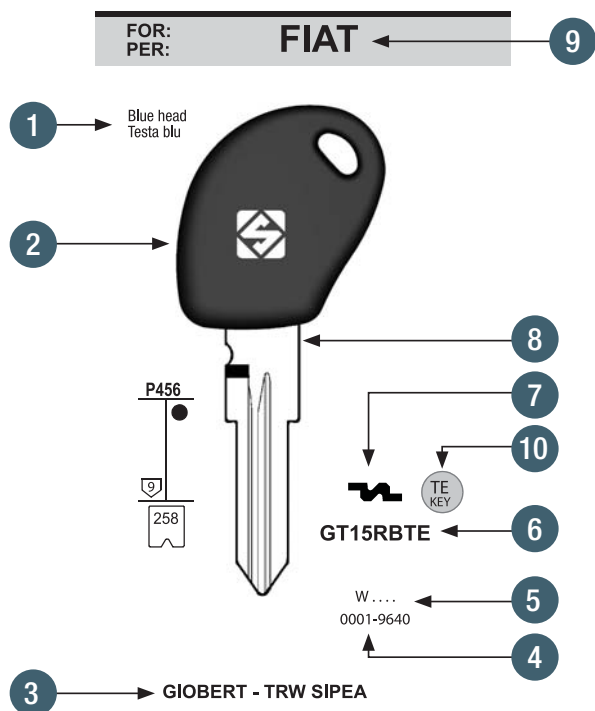

	EN	IT	DE	FR	ES	PT
1	Head Colour	Colore testa	Kopf-Farbe	Couleur tête	Color cabeza	Cor da cabeça
2	Head	Testa	Kopf	Tête	Cabeza	Cabeça
3	Secondary brands	Marche secondarie	Nebenmarke	Marques secondaires	Marcas secundarias	Marcas secundárias
4	Code	Serie	Serie	Code	Serie	Códigos
5	Original profile	Profilo originale	Originalprofil	Profil original	Perfil original	Perfil original
6	Silca reference	Referenza Silca	Silca-Artikel	Article Silca	Artículo Silca	Artigo Silca
7	Profile	Profilo	Profil	Profil	Perfil	Perfil
8	Blade (stem)	Canna	Schaft	Canne	Caña	Cana
9	Vehicle brand	Marca veicolo	Fahrzeuge-Marke	Marque véhicule	Marca vehículo	Marca do veículo
10	Key type	Tipo di chiave	Schlüsseltyp	Type de clé	Tipo de llave	Tipo de chave
11	Key uses	Utilizzi chiave	Verwendungen	Utilisations clé	Utilizaciones llave	Utilizações chave
12	Lock brand	Marca serratura	Schloß-Marke	Marque serrure	Marca cerradura	Marca da fechadura

**KEY IDENTIFICATION** - IDENTIFICAZIONE CHIAVE - SCHLÜSSELIDENTIFIKATION - IDENTIFICATION CLÉ - IDENTIFICACIÓN DE LA LLAVE - IDENTIFICAÇÃO DE UMA CHAVE

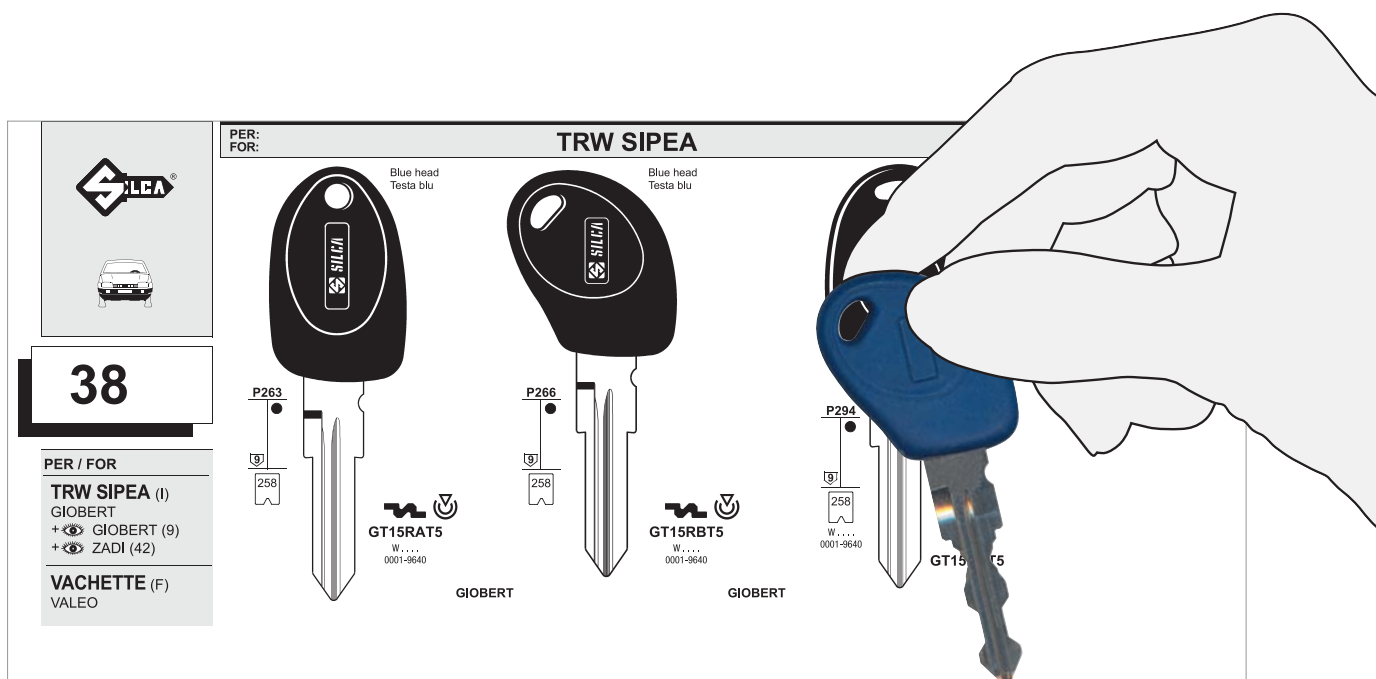

**EN**

**Keys are drawn to a 1:1 scale**

The key profile (section of the blade) is viewed from the head. To identify a key you may simply lay the key sample on the drawing, paying particular attention to the blade and to the profile.

Alternative head shapes are indicated by a dashed line around the standard head.

**IT**

**I disegni delle chiavi sono in scala 1:1**

I profili (sezione della canna) sono visti dalla testa. Per identificare una chiave basta sovrapporre il campione al disegno, prestando particolare attenzione alla canna (gambo) e alla sezione (profilo).

Teste originali diverse sono rappresentate con linea tratteggiata.

**DE**

**Die Zeichnungen der Schlüssel sind in Skala 1:1**

Die Profile (Schnitt des Schaftes) werden vom Kopf ab gesehen. Für die Identifikation eines Schlüssels genügt es den Musterschlüssel mit der angegebenen Zeichnung zu vergleichen, aber wir empfehlen, besonders den Schaft und das Profil zu überprüfen.

Verschiedene Originalköpfe sind durch gestrichelte Linien dargestellt.

**FR**

**Les dessins des clés sont à échelle 1:1**

Les profils (section de la canne) sont vus de la tête. Pour l'identification d'une clé il suffira de superposer la clé échantillon au dessin en examinant tout particulièrement la canne (tige) et la section (profil).

Têtes originales différentes sont représentées par des lignes en tirets.

**ES**

**Los dibujos de las llaves son en escala 1:1**

Los perfiles (sección de la caña) son vistos de la cabeza. Para la identificación de una llave basta sobreponer la llave de muestra al dibujo, examinando con particular atención la caña y la sección (perfil).

Las cabezas originales diferentes están representadas con una línea punteada.

**PT**

**Os desenhos das chaves estão em escala 1:1**

Os perfis (secção da cana) são vistos da cabeça. Para identificar uma chave basta sobrepor a chave original por cima do desenho e examinar atentamente a cana da chave e o perfil.



Cabeças originais diferentes estão representadas com uma linha tracejada.

# THE CAR BOOK 4

**TECHNICAL INFORMATION** - INFORMAZIONI TECNICHE - TECHNISCHE AUSKÜNFTE - INFORMATIONS TECHNIQUES - INFORMACIONES TÉCNICAS - INFORMAÇÕES TÉCNICAS



66

FOR / PER
<b>MERIT</b> (D)
<b>MERONI</b> (I)
<b>MONACOR</b> (PRC/CN)  ALPHA (63)
<b>NEIMAN</b> (D) (F) +  HUF (65)

**FOR:  
PER:**

MERIT

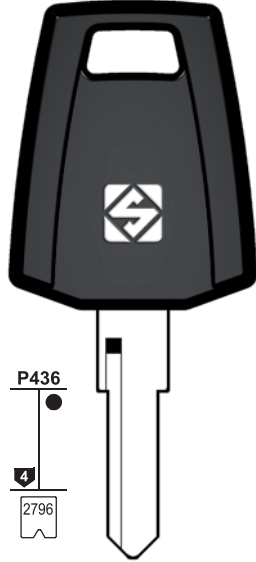

P436

2796

MRT2RAP

... C/D 001-050



NEIMAN



P83

122

NE76AP

... 0/9 ... 0/90/9  
M-N-P-R-S

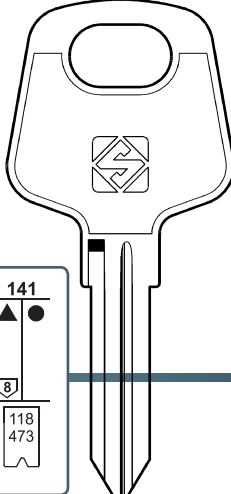



141

118  
473

NE19

GM ... 2001-3000  
... 2001-4949

**Uses (page XII)**  
 Utilizzi (pag. XII)  
 Verwendungen (Seite XII)  
 Utilisations (page XII)  
 Utilizaciones (pág. XII)  
 Utilizações (pág. XII)

FOR / PER	Main brand (Nationality)	Marca principale (Nazionalità)	Hauptmarke (Nationalität)	Marque principale (Nationalité)	Marca principal (Nacionalidad)	Marca principal (Nacionalidade)
<b>MERIT</b> (D)	Refer to main brand on the page indicated in brackets	Rinvio alla marca principale alla pagina indicata tra parentesi	Verweisung der Hauptmarke auf den angezeigten Seiten in Klammer	Renvoi à la marque principale à la page indiquée entre parenthèses	Reenvio a la marca principal en la paginas indicadas entre parentesis	Reenvia-se a marca principal em página indicada entre parênteses
<b>MERONI</b> (I)						
<b>MONACOR</b> (PRC)  ALPHA (63)						
<b>NEIMAN</b> (D) (F) +  HUF (65)	Refer to keyblanks under other brands on the pages indicated in brackets	Rinvio alle chiavi di altre marche alle pagine indicate tra parentesi	Verweisung auf die Schlüssel anderer Marken auf den angezeigten Seiten in Klammer	Renvoi aux clés d'autres marques aux pages indiquées entre parenthèses	Reenvio a las llaves de otras marcas en las paginas indicadas entre parentesis	Reenvia-se para chaves de outras marcas em páginas indicadas entre parênteses
<b>PK</b> (F)  CESSNA (64)  LAS (66)	<b>Nationality (page XIII)</b>	Nazionalità (pag. XIII)	Nationalität (Seite XIII)	Nationalité (page XIII)	Nacionalidad (pág. XIII)	Nacionalidade (pág. XIII)
<b>POS</b> (D)  SISPA (67)	<b>Secondary brands</b>	Marche secondarie	Nebenmarke	Marques secondaires	Marca secundarias	Marca secundárias
<b>SISPA</b> (I) POS						



**TECHNICAL INFORMATION - INFORMAZIONI TECNICHE - TECHNISCHE AUSKÜNFTE - INFORMATIONS TECHNIQUES - INFORMACIONES TÉCNICAS - INFORMAÇÕES TÉCNICAS**

**123** Information including material type is shown beside each key

A fianco di ogni chiave sono specificate alcune caratteristiche tecniche e varianti disponibili  
 Neben jedem Schlüssel sind einige technische Daten und mögliche Varianten angegeben  
 A côté de chaque clé sont indiqués les caractéristiques techniques et matériaux disponibles  
 Al lado de cada llave se especifican datos técnicos y variantes disponibles  
 Ao lado de cada chave esta indicado as características técnicas e a matéria prima em que a chave pode ser fornecida

	EN	IT	DE	FR	ES	PT
	<b>Standard production material:</b>	Materiale di normale produzione:	Material von normaler Produktion:	Matériel standard:	Material de producción corriente:	Matéria-prima standard:
▲	Steel	Acciaio	Stahl	Acier	Acero	Aço
●	Brass	Ottone	Messing	Laiton	Latón	Latão
■	Nickel silver	Alpacca	Neusilber	Maillechort	Alpaca	Alpaca
◆	Iron	Ferro	Eisen	Fer	Hierro	Ferro
<b>I 23</b>	<b>Head-shape code of each key to easily identify customized coining</b>	Codice testa per facilitare la scelta di conii personalizzati	Kopf-Code, um die Auswahl der Prägungen zu erleichtern	Code de la tête pour faciliter le choix des frappes personnalisées	Código de la cabeza para facilitar la elección de acuñaciones personalizados	Código da cabeça para facilitar a escolha dos cunhos, no caso dos pedidos de chaves personalizadas
©	Available in SILCA COLOR / SLIM COLOR	Disponibile in SILCA COLOR / SLIM COLOR	Lieferbar in SILCA COLOR / SLIM COLOR	Disponible en SILCA COLOR / SLIM COLOR	Disponible en SILCA COLOR / SLIM COLOR	Disponível em SILCA COLOR / SLIM COLOR
U	Available in ULTRALITE	Disponibile in ULTRALITE	Lieferbar in ULTRALITE	Disponible en ULTRALITE	Disponible en ULTRALITE	Disponível em ULTRALITE
5	No. of big pins	Nr. spine grandi	Nr. grosse Dornen	Nr. grands pistons	Nr. de agujas grandes	Nr. de pivos grandes
5	No. of small pins	Nr. spine piccole	Nr. kleinen Dornen	Nr. petits pistons	Nr. de agujas pequeñas	Nr. de pivos pequenos
▷	Back milled profile	Profilo dorsato	Rückengefrästes Profil	Profil à chiffrage dorsal	Perfil lomeado	Perfil boleado no dorso
456	Card Number for cutting by code on Silca electronic machines for flat keys	Numero scheda per riproduzione a codice con duplicatrici elettroniche Silca per chiavi piatte	Kartnummer für die Kopierung nach Code auf Silca Elektronische Schlüsselkopiermaschine für Flachschlüssel	Numéro de fiche pour la reproduction à code sur machines électroniques Silca pour clés plates	Número de la ficha para la reproducción en base a código con duplicadoras electrónicas Silca para llaves planas	Número de ficha técnica para a duplicação pelo código nas máquinas electrónicas Silca (chaves planas)
S56	Silca Serial Number for cutting by code on Silca electronic machines for dimple and laser keys	Silca Serial Number per riproduzione a codice con duplicatrici elettroniche Silca per chiavi punzonate e laser	Silca Serial Number für die Kopierung nach Code auf Silca Elektronische Schlüsselkopiermaschine für Bohrmulden- und Bahnschlüssel	Silca Serial Number pour la reproduction à code sur machines électroniques Silca pour clés a points et clés avec taille de type laser	Silca Serial Number para la reproducción en base a código con duplicadoras electrónicas Silca para llaves de regata y de seguridad	Silca Serial Number para a duplicação pelo código nas máquinas electrónicas Silca (chaves de pontos e tipo laser)
P47	Silca Serial Number for cutting by code on the Prima Laser and Idea Machines	Silca Serial Number per riproduzione a codice su Prima Laser e Idea	Silca Serial Number für die Kopierung nach Code auf Prima Laser und Idea Maschinen	Silca Serial Number pour la reproduction à code avec machines Prima Laser et Idea	Silca Serial Number para la reproducción en base a código con Prima Laser y Idea	Silca Serial Number para a duplicação pelo código nas máquinas Prima Laser e Idea

# THE CAR BOOK 4

## USES - UTILIZZI - VERWENDUNGEN - UTILISATIONS - UTILIZACIONES - UTILIZAÇÕES

	EN	IT	DE	FR	ES	PT
	Ignition and steering wheel lock	Avviamento / Bloccasterzo	Zünd-und Lenkradschloß	Mise en marche et antivol	Arranque seguro de dirección	Ignição, bloqueio da direção
	Door lock	Portiera	Wagentür	Portière	Puerta	Porta de carro
	Boot/Hatchback	Bagagliaio/Portiera posteriore	Kofferraum/Hecktür	Coffre/Portière postérieure	Maletero/Puerta trasera	Bagageira/Porta traseira
	Petrol cap	Tappo benzina	Benzintankverschluß	Bouchon réservoir	Tapa de gasolina	Tampão de gasolina
	Vehicle drawer	Vano portaoggetti	Schublade	Tiroir	Gaveta	Porta luvas
	Cycle seat	Sella	Sattel	Selle	Silla	Selím
	Helmet holder	Porta casco	Helm-Stütze	Porte-casque	Porta-casco	Porta-capacete
	Bicycle	Bicicletta	Fahrrad	Vélo	Bicicleta	Bicicleta
	Truck	Camion	LKW	Camion	Camión	Caminhão
	Van	Furgone	Lastwagen	Fourgon	Furgón	Furgão
	Mini-bus	Pulmino	Kleinbus	Minibus	Minibus	Mini-ônibus
	Pick-up truck	Camioncino/Pick-up	Kleinlasttransporter/Pick-up	Camionette/Pick-up	Camión ligero/Pick-up	Furgoneta/Pick-up
	Car	Auto	Auto	Voiture	Coche	Carro
	Motorcycle	Motocicletta	Motorrad	Motocyclette	Motocicletta	Motocicleta
	Airplane	Aereo	Flugzeug	Avion	Avión	Avião
	Caravan	Caravan	Caravan	Caravanne	Caravana	Caravana
	Boat engine	Motore marino	Schiffsmotor	Moteur de bateaux	Motor marino	Motor marítimo
	Ski holder	Portasci	Skiträger	Porte skis	Portaesquis	Porta-esquis
	Forklift	Muletto	Gabelstapler	Clark	Carretilla elevadora	Empilhadore
	Garage door	Porta garage	Garagentür	Portes de garages	Puerta garage	Porta de garagem
	Lawn-mower	Rasaerba	Rasenmäher	Tondeuse	Corta-cesped	Corta-relvas
	Tractor	Trattore	Traktor	Tracteur	Tractor	Trator
	Earth moving machine	Macchina movimento terra	Raupenschlepper	Machine pour déplacement de terre	Máquina para movimiento de tierra	Máquina de terraplenagem
	Anti-theft device for motor-cycles	Antifurto per ciclomotori e motociclette	Diebstahlschutz für Motorfahrrad und Motorräder	Anti-vol pour cyclomoteurs et motocyclettes	Antihurto para ciclomotores y motocicletas	Anti-roubo para scooters e motocicletas
	Remote Control	Telecomando	Fernbedienung	Commande à distance	Mando a distancia	Comando remoto
	Snowmobile	Motoslitta	Schneemobil	Motoluge	Trineo de motor	Trenó de motor
	Ski box	Baule portasci	Skiträger	Porte skis	Portaesquis	Porta-esquis
	Alarm	Allarme	Alarm	Alarme	Alarma	Alarme
	Motor heater	Riscaldatore motore	Motor Heizappart	Réchauffeur moteur	Calentador motor	Aquecedor de motor



## TRANSPONDER INFORMATION - INFORMAZIONI TRANSPONDER - TRANSPONDER AUSKÜNFTTE - INFORMATIONS TRANSPONDEUR - INFORMACIONES TRANSPONDER - INFORMAÇÕES TRANSPONDER

### EN

**TRANSPONDER.** An electronic chip with a non-volatile memory which contains an ELECTRONIC CODE. The transponder has an antenna with which it can interface with an external electronic control device. Through the antenna the device emits a fixed frequency signal; the transponder receives the signal and then transmits its electronic code by means of special modulation techniques to the control device, which is able to process the code. The transponder has no external input of power supply (passive system); it receives the energy necessary to work from the signal emitted by the external control device (inductive coupling between the control device antenna and that of the transponder).

**IMMOBILIZER.** An electronic antitheft system which interfaces with the engine control device, and often also with the starter, that allows the engine to start only when the electronic code in the transponder is recognized.

### DE

**TRANSPONDER.** Es handelt sich um einen mit einem nicht flüchtigen Speicher ausgestatteten elektronischen Chip, der einen ELEKTRONISCHEN CODE enthält. Der Transponder ist mit einer Lesespule versehen, die es ermöglicht, sich an ein externes elektronisches Steuergerät anzuschließen. Dieses Steuergerät gibt über eine Lesespule ein Signal mit einer bestimmten Frequenz (fix) ab; der Transponder nimmt dieses Signal auf und sendet unter Verwendung von spezifischen Modulationstechniken einen eigenen elektronischen Code an das Steuergerät, das ihn dann ausarbeitet. Der Vorteil des Transponders ist, daß keine äußere Versorgung notwendig ist (passives System), sondern daß die für den Betrieb nötige Energie dem vom externen Steuergerät gesendeten Signal entnommen wird (induktive Kopplung zwischen Lesespule des Steuergeräts und Antenne des Transponders).

**IMMOBILIZER.** Es handelt sich dabei um eine elektronische Diebstahlsicherung, die an das elektronische Steuergerät des Motors und oft auch an den Anlasser angeschlossen werden kann. Der Anlasser erteilt die Starterlaubnis, wenn der elektronische Code im Transponder erkannt wird.

### ES

**TRANSPONDER.** Chip electrónico provisto de memoria no volátil que contiene un CÓDIGO ELECTRÓNICO. El transponder está provisto de antena que permite interactuar con una central electrónica exterior. Esta central emite, por medio de una antena, una señal a frecuencia fija; el transponder, después de recibir la señal y utilizando técnicas particulares de modulación, envía su propio código electrónico a la central, que de esta manera está en condiciones de procesarlo. El transponder no necesita ningún suministro de corriente desde el exterior, sino que saca la energía necesaria a su propio funcionamiento de la señal que le llega de la central exterior (acoplamiento por inducción entre la antena de la central y la del transponder).

**SISTEMA IMMOBILIZADOR.** Es un sistema antirrobo de tipo electrónico que, al interactuar con la central de control del motor y a menudo incluso con el motor de arranque, da el consentimiento al encendido del motor, cuando reconozca el código electrónico presente en el transponder.

### IT

**TRANSPONDER.** Chip elettronico dotato di memoria non volatile contenente un CODICE ELETTRONICO. Il transponder è dotato di antenna che permette di interfacciarsi con una centralina elettronica. La centralina emette tramite un'antenna un segnale a frequenza fissa; il transponder, ricevuto tale segnale, invia il proprio codice elettronico tramite particolari tecniche di modulazione alla centralina, che è in grado di elaborarlo e riconoscerlo. Il transponder non ha nessun tipo di alimentazione esterna (è un sistema passivo); ricava l'energia necessaria al suo funzionamento dal segnale inviato dalla centralina (ACCOPIAMENTO INDUTTIVO fra antenna della centralina e del transponder).

**SISTEMA IMMOBILIZZATORE.** Sistema antifurto di tipo elettronico in grado di interfacciarsi con la centralina di controllo motore e spesso anche con il motorino d'avviamento, che dà il consenso di accensione motore nel caso in cui venga riconosciuto il codice elettronico presente nel transponder.

### FR

**TRANSPONDEUR.** Chip électronique doté de mémoire non volatile contenant un CODE ELECTRONIQUE. Le transpondeur est doté d'une antenne permettant l'interface avec une unité de contrôle. Cette unité de contrôle émet un signal à fréquence fixe; le transpondeur, reçoit ce signal, en appliquant des techniques de modulations spéciales, il envoie son propre code électronique à l'unité de contrôle qui est ainsi en mesure d'en effectuer le traitement. Le transpondeur n'a besoin d'aucune alimentation externe (système passif); prélevant l'énergie qu'il lui faut pour fonctionner du signal envoyé par l'unité de contrôle (couplage inductif entre l'antenne de l'unité de contrôle et celle du transpondeur).

**SYSTEME D'IMMOBILISATION.** C'est un antivol de type électronique qui, interfacé avec l'unité de contrôle du moteur et la plupart des cas avec le démarreur, donne le consentement au démarrage du moteur après identification du code électronique présent dans le transpondeur.

### PT

**TRANSPONDER.** Chip electrónico dotado de memória não volátil que contém um CÓDIGO ELECTRÓNICO (número). O transponder está provisto de uma antena que permite a ligação em interface com uma central electrónica. A central emite, por meio de uma antena, um sinal com frequência fixa; recebido esse sinal, o transponder, por meio de técnicas especiais de modulação, envia o próprio código electrónico para a central, que o pode processar e reconhecer. O transponder não tem algum tipo de alimentação externa (é um sistema passivo); tira a energia necessária para o seu funcionamento do sinal enviado pela central (ACOPLAMENTO INDUTIVO entre a antena da central e do transponder).

**SISTEMA DE IMOBILIZAÇÃO.** Sistema anti-roubo de tipo electrónico que pode ser ligado em interface com a centralina de controlo do motor e frequentemente até com o motor de arranque, e que habilita a ignição do motor no caso em que seja reconhecido o código electrónico presente no transponder.

## NATIONALITY - NAZIONALITÀ - NATIONALITÄT - NATIONALITÉ - NACIONALIDAD - NACIONALIDADE

<b>A</b> Austria	<b>CZ</b> Czech Republic	<b>GR</b> Greece	<b>LT</b> Lithuania	<b>RCH</b> Chile	<b>USA</b> United States of America
<b>AUS</b> Australia	<b>D</b> Germany	<b>H</b> Hungary	<b>LV</b> Latvia	<b>RNR</b> Zambia	<b>UA</b> Ukraine
<b>AZ</b> Azerbaijan	<b>DK</b> Denmark	<b>HK</b> Hong-Kong	<b>MD</b> Republic of Moldova	<b>RO</b> Romania	<b>WAN</b> Federal Republic of Nigeria
<b>B</b> Belgium	<b>DZ</b> Algeria	<b>HR</b> Croatia	<b>N</b> Norway	<b>RUS</b> Russia	<b>YV</b> Venezuela
<b>BG</b> Bulgaria	<b>E</b> Spain	<b>I</b> Italy	<b>NL</b> The Netherlands	<b>S</b> Sweden	<b>ZA</b> Republic of South Africa
<b>BR</b> Brazil	<b>EST</b> Estonia	<b>IL</b> Israel	<b>P</b> Portugal	<b>SRB</b> Serbia	
<b>BY</b> Belarus	<b>ET</b> Egypt	<b>IND</b> India	<b>PL</b> Poland	<b>SLO</b> Slovenia	
<b>CDN</b> Canada	<b>F</b> France	<b>IRL</b> Ireland	<b>PRC/CN</b> China	<b>SU</b> ex-URSS	
<b>CH</b> Switzerland	<b>FIN</b> Finland	<b>J</b> Japan	<b>RA</b> Argentina	<b>TN</b> Tunisia	
<b>CO</b> Colombia	<b>GB</b> Great Britain	<b>KSA</b> Saudi Arabia	<b>RC/TW</b> Taiwan	<b>TR</b> Turchia	



## KEY TYPES - TIPI DI CHIAVE - SCHLÜSSELTYPEN - TYPES DE CLÉ - TIPOS DE LLAVE - TIPOS DE CHAVE

SYMBOLS - SIMBOLI - SYMBOLE - SYMBOLES - SÍMBOLOS - SÍMBOLOS	
	<p><b>TRANSPONDER KEYS</b></p>  <p><b>TRANSPONDER KEYS.</b> Keys endowed with specific fixed or crypto code transponder depending on the application.</p> <p><b>CHIAVI TRANSPONDER.</b> Chiavi dotate di transponder a codice fisso o crypto specifico in base all'applicazione.</p> <p><b>TRANSPONDERSCHLÜSSEL.</b> Schlüssel mit spezifischem Fixer oder Crypto Code Transponder gemäß der Anwendung.</p> <p><b>CLÉS TRANSPONDEUR.</b> Clés dotées d'un transpondeur à code fixe ou crypto spécifique selon l'application.</p> <p><b>LLAVES TRANSPONDER.</b> Llaves dotadas de transponder de código fijo o crypto específico en función de la aplicación.</p> <p><b>CHAVES TRANSPONDER.</b> Chaves dotadas de um transponder de código fixo ou crypto específico dependendo da aplicação.</p>
	<p><b>FLIP KEYS</b></p>  <p><b>FLIP KEYS.</b> Metallic blade for Flip Keys, Silca's vehicle keys reproducing the original key's flip mechanism. Key reference ending in FH (Flip Head). The blade must be assembled with the Flip plastic head.</p> <p><b>CHIAVI FLIP.</b> Canna metallica per Chiavi Flip, la chiave veicolo Silca che riproduce il meccanismo "flip" della chiave originale. Referenza chiave terminante in FH (Flip Head). La canna deve essere assemblata alla testa in plastica Flip.</p> <p><b>KLAPPSCHLÜSSEL.</b> Metall-Schaft für Klappschlüssel, Silcas Autonachschlüssel mit dem gleichen Klappmechanismus wie das Original. FH (Flip Head) Buchstabe am Ende der Artikelnummer. Der Schaft muss mit der Plastik-Klappschlüssel-Kopf montiert werden.</p> <p><b>CLÉS FLIP.</b> Insert en metal pour Clés Flip, les clés de véhicule Silca capables de reproduire le mécanisme original d'une clé pliable. Référence terminant en FH (Flip Head). L'insert doit être assemblé avec la tête en plastique Flip.</p> <p><b>LLAVES PLEGABLES.</b> Espadín metálico para Llaves Plegables, las llaves de vehículo Silca que reproducen el mecanismo de despliegue de la llave original. Referencia que termina por FH (Flip Head). El espadín debe ser ensamblado con el cabezal de plástico de la Llave Plegable.</p> <p><b>CHAVES FLIP.</b> Perfil metálico para Chaves Flip, as chaves para reposição das chaves veículos de canivete originais. Referência que acaba em FH (Flip Head). O perfil deve ser montado com a cabeça de plástico Flip.</p>
	<p><b>MH KEYS</b></p>  <p><b>MH KEYS.</b> Silca MH Keys include both the electronic keys range with MH head containing the electronic card, and the MH-TA keys range with GTI compatible transponder adapter. The MH-TA keys do not include the transponder.</p> <p><b>CHIAVI MH.</b> Le Chiavi MH comprendono sia la gamma di chiavi elettroniche con testa MH dotata di scheda elettronica, sia la gamma di chiavi MH-TA, dotata di adattatore transponder in grado di ospitare il GTI. Le chiavi MH-TA non includono il transponder.</p> <p><b>MH-SCHLÜSSEL.</b> Die MH-Schlüssel bestehen aus sowohl die Palette der elektronischen Schlüssel mit MH Kopf mit elektronischer Karte, als auch die Palette der MH-TA Schlüssel mit Transponderadapter, der den GTI aufnehmen kann. Die MH-TA Schlüssel enthalten nicht den Transponder.</p> <p><b>CLÉS MH.</b> Les Clés MH comprennent à la fois la gamme de clés électroniques avec tête MH avec carte électronique, à la fois la gamme de clés MH-TA dotées d'adaptateur pour transpondeurs pouvant accueillir le GTI. Les clés MH-TA ne incluent pas le transponder.</p> <p><b>LLAVES MH.</b> Las Llaves MH incluyen tanto la gama de llaves electrónicas con cabeza MH con ficha electrónica, tanto la gama de llaves MH-TA dotadas de adaptador transponder que puede acomodar el GTI. Las llaves MH-TA no incluyen el transponder.</p> <p><b>CHAVES MH.</b> As Chaves MH incluem tanto a gama de chaves eletrónicas com cabeça MH com ficha eletrónica, tanto a gama de chaves MH-TA equipadas com adaptador para transponder que pode acomodar o GTI. As chaves MH-TA não incluem o transponder.</p>
	<p><b>LOOK A-LIKE KEYS</b></p>  <p><b>LOOK A-LIKE KEYS.</b> GTI compatible transponder keys with key head design identical to the original and key reference ending in TE (Transponder Empty). Key with adapter, without transponder.</p> <p><b>CHIAVI LOOK A-LIKE.</b> Chiavi transponder compatibili con il GTI caratterizzate da design della testa identico alla chiave originale e referenza terminante in TE (Transponder Empty). Chiave con adattatore, senza transponder.</p> <p><b>LOOK A-LIKE SCHLÜSSEL.</b> Kompatibel mit GTI Transponder Schlüssel mit Kopf-Design entsprechend dem Original-Schlüssel und TE (Transponder Empty) Buchstabe am Ende der Artikelnummer. Schlüssel mit Adapter, ohne Transponder.</p> <p><b>CLÉS LOOK A-LIKE.</b> Clés transpondeur compatibles avec le GTI caractérisées par design de la tête identique à la clé originale et référence terminant en TE (Transponder Empty). Clé avec adaptateur, sans transpondeur.</p> <p><b>LLAVES LOOK A-LIKE.</b> Llaves transponder compatibles con el GTI caracterizadas por el mismo diseño de la llave original y por la referencia que termina por TE (Transponder Empty). Llaves con adaptador, sin transponder.</p> <p><b>CHAVES LOOK A-LIKE.</b> Chaves transponder compatíveis com o GTI caracterizadas por o formato da cabeça igual às chaves originais e a referência que acaba em TE (Transponder Empty). Chave com adaptador, sem transponder.</p>
	<p><b>KEYLESS KEYS KIT</b></p>  <p><b>KEYLESS KEYS KIT.</b> Silca Keyless Keys kit includes: plastic key with GTI compatible transponder adapter; metallic key with plastic head to open the vehicle doors; metallic ring. The transponder is not included in the kit.</p> <p><b>KIT CHIAVI KEYLESS.</b> Il kit Chiavi Silca Keyless comprende: chiave in plastica con adattatore transponder compatibile con il GTI; chiave in metallo con testa in plastica per l'apertura delle portiere; anello metallico. Il transponder non è incluso nel kit.</p> <p><b>KEYLESS SCHLÜSSEL SET.</b> Das Silca Keyless Schlüssel Set enthält: Plastik-Schlüssel mit Transponderadapter kompatibel mit GTI; Metallschlüssel mit Plastik-Kopf zum Öffnen der Türen; Metallring. Das Set enthält nicht den Transponder.</p> <p><b>KIT CLÉS KEYLESS.</b> Le kit Clés Silca Keyless inclut: clé en plastique avec adaptateur pour transpondeur compatible avec le GTI; clé en métal avec tête en plastique pour le déverrouillage des portières; anneau en métal. Le kit n'inclut pas le transpondeur.</p> <p><b>KIT LLAVES KEYLESS.</b> El kit Llaves Keyless incluye: llave de plástico con adaptador transponder compatible con el GTI; llave metálica con cabeza de plástico para abrir las puertas; anillo metálica. El transponder no está incluido en el kit.</p> <p><b>KIT CHAVES KEYLESS.</b> O kit Chaves Keyless inclui: chave de plástico com adaptador transponder compatível com o GTI; chave metálica com cabeça em plástico para a abertura das portas; anel metálico. O transponder não está incluído no kit.</p>



Car keys guide  
Guida chiavi auto  
Marktführer für Autoschlüssel  
Guide clés pour voitures  
Guía llaves para coches  
Guia chaves para carros







**VEHICLES GUIDE LEGEND - LEGENDA GUIDA VEICOLI - AUTOSCHLÜSSEL ERLÄUTERUNG - LÉGENDE GUIDE VÉHICULES - LEYENDA GUÍA PARA VEHÍCULOS - LEGENDA GUIA PARA VEÍCULOS**

	<p><b>Make and model</b>          Marca e modello          Marke und Modell          Marque et modèle          Marca y modelo          Marca e modelo</p>	<p><b>COPY</b></p> <p><b>GTI</b></p>	<p><b>Indicates the possibility to copy the original key on GTI transponder using RW4 + P-BOX, FAST COPY + P-BOX, RW4 PLUS and FAST COPY PLUS devices.</b></p> <p>Indica la possibilità di copiare la chiave originale su transponder GTI utilizzando i dispositivi RW4 + P-BOX, FAST COPY + P-BOX, RW4 PLUS e FAST COPY PLUS.</p> <p>Zeigt die Möglichkeit an, dass Sie die Originalschlüssel auf dem Transponder GTI mit folgenden Geräten RW4 + P-BOX, FAST COPY + P-BOX, RW4 PLUS und FAST COPY PLUS kopieren können.</p> <p>Indique qu'il est possible de copier la clé originale sur le transpondeur GTI avec les dispositifs RW4 + P-BOX, FAST COPY + P-BOX, RW4 PLUS et FAST COPY PLUS.</p> <p>Indica la posibilidad de copiar la llave original en el transponder GTI con los dispositivos RW4 + P-BOX, FAST COPY + P-BOX, RW4 PLUS y FAST COPY PLUS.</p> <p>Indica a capacidade de copiar a chave original no transponder GTI Silca usando os dispositivos RW4 + P-BOX, FAST COPY + P-BOX, RW4 PLUS e FAST COPY PLUS.</p>
<p><b>FROM</b></p>	<p><b>In production from...</b>          Fabbricata dal...          Hergestellt seit...          Fabriquée à partir du...          Fabricada desde...          Fabricada desde...</p>	<p><b>GEN.</b></p> <p><b>GTI</b></p>	<p><b>Indicates the possibility to generate a crypto transponder code on GTI transponder using TRP SETTING program with RW4 + P-BOX, FAST COPY + P-BOX, RW4 PLUS and FAST COPY PLUS devices.</b></p> <p>Indica la possibilità di generare il codice per transponder crypto su transponder GTI utilizzando il programma TRP SETTING con i dispositivi RW4 + P-BOX, FAST COPY + P-BOX, RW4 PLUS e FAST COPY PLUS.</p> <p>Zeigt die Möglichkeit an, den Code für Transponder Crypto auf dem Transponder GTI unter Verwendung des Programm TRP SETTING mit den Geräten RW4 + P-BOX, FAST COPY + P-BOX, RW4 PLUS und FAST COPY PLUS zu generieren.</p> <p>Indique qu'il est possible de générer le code pour transpondeur crypto sur transpondeur GTI en utilisant le programme TRP SETTING sur les dispositifs RW4 + P-BOX, FAST COPY + P-BOX, RW4 PLUS et FAST COPY PLUS.</p> <p>Indica la posibilidad de generar el código para transponder crypto en el transponder GTI utilizando el programa TRP SETTING con los dispositivos RW4 + P-BOX, FAST COPY + P-BOX, RW4 PLUS y FAST COPY PLUS.</p> <p>Indica a capacidade de gerar o código para transponders crypto no transponders GTI utilizando o programa TRP SETTING usando os dispositivos RW4 + P-BOX, FAST COPY + P-BOX, RW4 PLUS e FAST COPY PLUS.</p>
<p><b>TO</b></p>	<p><b>In production until...</b>          Fabbricata fino al...          Hergestellt bis...          Fabriquée jusqu'au...          Fabricada hasta...          Fabricada até...</p>	<p><b>ID</b></p> <p><b>FAST COPY RW4</b></p> <p><b>FAST COPY PLUS RW4 PLUS</b></p>	<p><b>Indicates the possibility to generate a crypto transponder code on GTI transponder using TRP SETTING program with RW4 + P-BOX, FAST COPY + P-BOX, RW4 PLUS and FAST COPY PLUS devices.</b></p> <p>Indica la possibilità di generare il codice per transponder crypto su transponder GTI utilizzando il programma TRP SETTING con i dispositivi RW4 + P-BOX, FAST COPY + P-BOX, RW4 PLUS e FAST COPY PLUS.</p> <p>Zeigt die Möglichkeit an, den Code für Transponder Crypto auf dem Transponder GTI unter Verwendung des Programm TRP SETTING mit den Geräten RW4 + P-BOX, FAST COPY + P-BOX, RW4 PLUS und FAST COPY PLUS zu generieren.</p> <p>Indique qu'il est possible de générer le code pour transpondeur crypto sur transpondeur GTI en utilisant le programme TRP SETTING sur les dispositifs RW4 + P-BOX, FAST COPY + P-BOX, RW4 PLUS et FAST COPY PLUS.</p> <p>Indica la posibilidad de generar el código para transponder crypto en el transponder GTI utilizando el programa TRP SETTING con los dispositivos RW4 + P-BOX, FAST COPY + P-BOX, RW4 PLUS y FAST COPY PLUS.</p> <p>Indica a capacidade de gerar o código para transponders crypto no transponders GTI utilizando o programa TRP SETTING usando os dispositivos RW4 + P-BOX, FAST COPY + P-BOX, RW4 PLUS e FAST COPY PLUS.</p>
<p><b>SILCA REF.</b></p> <p><b>REF.</b></p>	<p><b>Silca key reference</b>          Referenza chiave Silca          Silca-Schlüssel-Referenz          Référence clé Silca          Referencia llave Silca          Referência chave Silca</p>	<p><b>ID</b></p> <p><b>FAST COPY RW4</b></p> <p><b>FAST COPY PLUS RW4 PLUS</b></p>	<p><b>Indicates the possibility to generate a crypto transponder code on GTI transponder using TRP SETTING program with RW4 + P-BOX, FAST COPY + P-BOX, RW4 PLUS and FAST COPY PLUS devices.</b></p> <p>Indica la possibilità di generare il codice per transponder crypto su transponder GTI utilizzando il programma TRP SETTING con i dispositivi RW4 + P-BOX, FAST COPY + P-BOX, RW4 PLUS e FAST COPY PLUS.</p> <p>Zeigt die Möglichkeit an, den Code für Transponder Crypto auf dem Transponder GTI unter Verwendung des Programm TRP SETTING mit den Geräten RW4 + P-BOX, FAST COPY + P-BOX, RW4 PLUS und FAST COPY PLUS zu generieren.</p> <p>Indique qu'il est possible de générer le code pour transpondeur crypto sur transpondeur GTI en utilisant le programme TRP SETTING sur les dispositifs RW4 + P-BOX, FAST COPY + P-BOX, RW4 PLUS et FAST COPY PLUS.</p> <p>Indica la posibilidad de generar el código para transponder crypto en el transponder GTI utilizando el programa TRP SETTING con los dispositivos RW4 + P-BOX, FAST COPY + P-BOX, RW4 PLUS y FAST COPY PLUS.</p> <p>Indica a capacidade de gerar o código para transponders crypto no transponders GTI utilizando o programa TRP SETTING usando os dispositivos RW4 + P-BOX, FAST COPY + P-BOX, RW4 PLUS e FAST COPY PLUS.</p>
<p><b>SILCA TE</b></p> <p><b>"TE" SILCA REF.</b></p>	<p><b>Silca TE key reference</b>          Referenza chiave Silca TE          Silca TE Schlüssel-Referenz          Référence clé Silca TE          Referencia llave Silca          Referência chave Silca TE</p>		
<p><b>SILCA FLIP</b></p> <p><b>"FLIP KEYS" SILCA REF.</b></p>	<p><b>Silca Flip Key reference</b>          Referenza Chiave Flip Silca          Silca Klappschlüssel-Referenz          Référence Clé Flip Silca          Referencia Llave Plegable Silca          Referência Chave Flip Silca</p>		
	<p><b>Type of transponder on the original key (1)</b>          Tipo di transponder presente nella chiave originale (1)          Transpondertyp im Originalschlüssel (1)          Type de transpondeur présent dans la clé originale (1)          Tipo de transponder presente en la llave original (1)          Tipo de transponder presente na chave original (1)</p>		

# THE CAR BOOK 4

## VEHICLES GUIDE LEGEND - LEGENDA GUIDA VEICOLI - AUTOSCHLÜSSEL ERLÄUTERUNG - LÉGENDE GUIDE VÉHICULES - LEYENDA GUÍA PARA VEHÍCULOS - LEGENDA GUIA PARA VEÍCULOS

<p style="text-align: center;"><b>COPY</b></p>  <p style="text-align: center;"><b>FAST COPY PLUS RW4 PLUS</b></p>	<p><b>Copy of key by FAST COPY PLUS / RW4 PLUS</b> The symbols show:</p> <ul style="list-style-type: none"> <li>- <b>Y:</b> Can be copied with FAST COPY PLUS / RW4 PLUS;</li> <li>- <b>RD:</b> You must first identify the key to know if it can be copied or not;</li> <li>- <b>ID:</b> The FAST COPY PLUS / RW4 PLUS is able to duplicate the ID (part of the electronic code) of Philips* Crypto transponders.</li> </ul> <p>Copia della chiave tramite FAST COPY PLUS / RW4 PLUS I simboli identificano:</p> <ul style="list-style-type: none"> <li>- <b>Y:</b> Copiabile con FAST COPY PLUS / RW4 PLUS;</li> <li>- <b>RD:</b> Indica che è necessario leggere la chiave per sapere se questa è duplicabile o no;</li> <li>- <b>ID:</b> FAST COPY PLUS / RW4 PLUS è in grado di duplicare l'identificatore (parte del codice elettronico) del transponder Crypto Philips*.</li> </ul> <p>Kopie des Schlüssels mit FAST COPY PLUS / RW4 PLUS Die Symbole zeigen an:</p> <ul style="list-style-type: none"> <li>- <b>Y:</b> Kopierbar mit FAST COPY PLUS / RW4 PLUS;</li> <li>- <b>RD:</b> Zeigt an, dass der Schlüssel gelesen werden muss, um festzustellen, ob er kopierbar ist oder nicht;</li> <li>- <b>ID:</b> FAST COPY PLUS / RW4 PLUS kopiert den Identifikator (Teil des elektronischen Codes) des Transponders Crypto Philips*.</li> </ul> <p>Copie de la clé par FAST COPY PLUS / RW4 PLUS Les symboles indiquent:</p> <ul style="list-style-type: none"> <li>- <b>Y:</b> Copiable avec FAST COPY PLUS / RW4 PLUS;</li> <li>- <b>RD:</b> Indique qu'il faut lire la clé pour savoir si elle est reproductible ou pas;</li> <li>- <b>ID:</b> FAST COPY PLUS / RW4 PLUS est en mesure de reproduire l'identificateur (partie du code électronique) du transpondeur Crypto Philips*.</li> </ul> <p>Copia de la llave por medio de FAST COPY PLUS / RW4 PLUS Los símbolos identifican:</p> <ul style="list-style-type: none"> <li>- <b>Y:</b> Copiable con FAST COPY PLUS / RW4 PLUS;</li> <li>- <b>RD:</b> Indica que es necesario leer la llave para saber si ésta es duplicable o no;</li> <li>- <b>ID:</b> FAST COPY PLUS / RW4 PLUS es capaz de duplicar el identificador (parte del código electrónico) del transponder Crypto Philips*.</li> </ul> <p>Cópia da chave por meio de FAST COPY PLUS / RW4 PLUS Os símbolos identificam:</p> <ul style="list-style-type: none"> <li>- <b>Y:</b> Pode ser copiada com FAST COPY PLUS / RW4 PLUS;</li> <li>- <b>RD:</b> Indica que é necessário ler a chave para saber se ela pode ou não ser duplicada.</li> <li>- <b>ID:</b> FAST COPY PLUS / RW4 PLUS pode duplicar o identificador (parte do código eletrônico) do transponder Crypto Philips*.</li> </ul>
<p style="text-align: center;"><b>ID</b></p>  <p style="text-align: center;"><b>FAST COPY RW4</b></p>	<p><b>Identification of transponder type by FAST COPY / RW4 (2) (4)</b></p> <p>Identificazione tipo di transponder tramite FAST COPY / RW4 (2) (4)</p> <p>Identifizierung des Transpondertyps mit Hilfe der FAST COPY / RW4 (2) (4)</p> <p>Identification du type de transpondeur par FAST COPY / RW4 (2) (4)</p> <p>Identificación tipo de transponder por medio de FAST COPY / RW4 (2) (4)</p> <p>Identificação do tipo de transponder por meio de FAST COPY / RW4 (2) (4)</p>
<p style="text-align: center;"><b>COPY</b></p>  <p style="text-align: center;"><b>FAST COPY RW4</b></p>	<p><b>Copy of key by FAST COPY / RW4</b> The symbols show:</p> <ul style="list-style-type: none"> <li>- <b>Y:</b> Can be copied with FAST COPY / RW4;</li> <li>- <b>P-BOX:</b> Can be copied with FAST COPY + P-BOX / RW4 + P-BOX;</li> <li>- <b>RD:</b> You must first identify the key to know if it can be copied or not;</li> <li>- <b>ID:</b> The FAST COPY / RW4 is able to duplicate the ID (part of the electronic code) of Philips* Crypto transponders.</li> </ul> <p>Copia della chiave tramite FAST COPY / RW4 I simboli identificano:</p> <ul style="list-style-type: none"> <li>- <b>Y:</b> Copiabile con FAST COPY / RW4;</li> <li>- <b>P-BOX:</b> Copiabile con FAST COPY + P-BOX / RW4 + P-BOX;</li> <li>- <b>RD:</b> Indica che è necessario leggere la chiave per sapere se questa è duplicabile o no;</li> <li>- <b>ID:</b> FAST COPY / RW4 è in grado di duplicare l'identificatore (parte del codice elettronico) del transponder Crypto Philips*.</li> </ul> <p>Kopie des Schlüssels mit FAST COPY / RW4 Die Symbole zeigen an:</p> <ul style="list-style-type: none"> <li>- <b>Y:</b> Kopierbar mit FAST COPY / RW4;</li> <li>- <b>P-BOX:</b> Kopierbar mit FAST COPY + P-BOX / RW4 + P-BOX;</li> <li>- <b>RD:</b> Zeigt an, dass der Schlüssel gelesen werden muss, um festzustellen, ob er kopierbar ist oder nicht;</li> <li>- <b>ID:</b> FAST COPY / RW4 kopiert den Identifikator (Teil des elektronischen Codes) des Transponders Crypto Philips*.</li> </ul> <p>Copie de la clé par FAST COPY / RW4 Les symboles indiquent:</p> <ul style="list-style-type: none"> <li>- <b>Y:</b> Copiable avec FAST COPY / RW4;</li> <li>- <b>P-BOX:</b> Copiable avec FAST COPY + P-BOX / RW4 + P-BOX;</li> <li>- <b>RD:</b> Indique qu'il faut lire la clé pour savoir si elle est reproductible ou pas;</li> <li>- <b>ID:</b> FAST COPY / RW4 est en mesure de reproduire l'identificateur (partie du code électronique) du transpondeur Crypto Philips*.</li> </ul> <p>Copia de la llave por medio de FAST COPY / RW4 Los símbolos identifican:</p> <ul style="list-style-type: none"> <li>- <b>Y:</b> Copiable con FAST COPY / RW4;</li> <li>- <b>P-BOX:</b> Copiable con FAST COPY + P-BOX / RW4 + P-BOX;</li> <li>- <b>RD:</b> Indica que es necesario leer la llave para saber si ésta es duplicable o no;</li> <li>- <b>ID:</b> FAST COPY / RW4 es capaz de duplicar el identificador (parte del código electrónico) del transponder Crypto Philips*.</li> </ul> <p>Cópia da chave por meio de FAST COPY / RW4 Os símbolos identificam:</p> <ul style="list-style-type: none"> <li>- <b>Y:</b> Pode ser copiada com FAST COPY / RW4;</li> <li>- <b>P-BOX:</b> Pode ser copiada com FAST COPY + P-BOX / RW4 + P-BOX;</li> <li>- <b>RD:</b> Indica que é necessário ler a chave para saber se ela pode ou não ser duplicada.</li> <li>- <b>ID:</b> FAST COPY / RW4 pode duplicar o identificador (parte do código eletrônico) do transponder Crypto Philips*.</li> </ul>

**VEHICLES GUIDE LEGEND - LEGENDA GUIDA VEICOLI - AUTOSCHLÜSSEL ERLÄUTERUNG - LÉGENDE GUIDE VÉHICULES - LEYENDA GUÍA PARA VEHÍCULOS - LEGENDA GUIA PARA VEÍCULOS**

<p><b>STP</b></p>	<p><b>Indicates the possibility to generate codes for new transponder keys using STP + RW2 or STP + RW3 or STP + RW4 or STP + FAST COPY or STP + RW4 PLUS or STP + FAST COPY PLUS (5)</b></p> <p>Indica la possibilità di generare il codice per nuove chiavi transponder utilizzando STP + RW2 oppure STP+ RW3 oppure STP + RW4 oppure STP + FAST COPY oppure STP + RW4 PLUS oppure STP + FAST COPY PLUS (5)</p> <p>Zeigt an, dass der Code für neue Transponderschlüssel mit dem STP + RW2 oder STP + RW3 oder STP + RW4 oder STP + FAST COPY oder STP + RW4 PLUS oder STP + FAST COPY PLUS generiert werden kann (5)</p> <p>Indique la possibilité de générer le code pour de nouvelles clés transpondeur en utilisant STP + RW2 ou STP + RW3 ou STP + RW4 ou STP + FAST COPY ou STP + RW4 PLUS ou STP + FAST COPY PLUS (5)</p> <p>Indica la posibilidad de generar el código para nuevas llaves transponder utilizando STP + RW2 o STP + RW3 o STP + RW4 o STP + FAST COPY o STP + RW4 PLUS o STP + FAST COPY PLUS (5)</p> <p>Indica a possibilidade de gerar o código para novas chaves transponder utilizando STP + RW2 ou STP + RW3 ou STP + RW4 ou STP + FAST COPY ou STP + RW4 PLUS ou STP + FAST COPY PLUS (5)</p>	<p><b>Boot / Hatchback</b>          Bagagliaio / Portiera posteriore          Koferraum / Hecktür          Coffre / Portière postérieure          Maletero / Puerta trasera          Bagageira / Porta traseira</p> <p><b>Cycle seat</b>          Sella          Sattel          Selle          Silla          Selim</p>	<p><b>Petrol cap</b>          Tappo benzina          Benzintankverschluss          Bouchon réservoir          Tapa de gasolina          Tampão de gasolina</p>
	<p><b>Key memorization procedure on the vehicle without using devices (instructions in the STP program).</b></p> <p>Tipo di procedura di memorizzazione della chiave sull'autovettura senza l'utilizzo di dispositivi (istruzioni all'interno del programma STP).</p> <p>Speicherung des Schlüssels im Auto ohne Verwendung der Geräten (Anleitungen im Programm STP).</p> <p>Procédure de mise en mémoire de la clé sur le véhicule sans utiliser de dispositifs (voir instructions dans le programme STP).</p> <p>Procedimiento de memorización de la llave en el vehículo sin el uso de dispositivos (instrucciones en el interior del programa STP).</p> <p>Tipo de procedimento de memorização da chave no veículo sem utilizar nenhum dispositivo (instruções no programa STP).</p>	<p><b>Vehicle drawer</b>          Cassetto          Schublade          Tiroir          Gaveta          Porta-luvas</p>	<p><b>All the following information reported in columns 6, 42+71, 72, 43/44a, 12, 15 regard car/motorcycle/truck ignition.</b></p> <p>Tutti i simboli e le informazioni contenute nelle colonne 6, 42+71, 72, 43/44a, 12, 15 sono relative all'accensione dell'auto/motocicletta/camion.</p> <p>Alle Symbole und Informationen in den Spalten 6, 42+71, 72, 43/44a, 12, 15 beziehen sich auf die Zündung des Autos/Motorrads/LKW.</p> <p>Tous les symboles et les informations reportées dans les colonnes 6, 42+71, 72, 43/44a, 12, 15 sont relatifs à l'allumage de la voiture/motocyclette/camion.</p> <p>Todos los símbolos y las informaciones en las columnas 6, 42+71, 72, 43/44a, 12, 15 son relativas al encendido del coche/motocicleta/camion.</p> <p>Todos os símbolos e as informações contidas nas colunas 6, 42+71, 72, 43/44a, 12, 15 dizem respeito à ignição de carro/motocicleta/camião.</p>
<p><b>Door lock</b>          Portiera          Türe          Portière          Puerta          Porta</p> <p><b>Antitheft device for motorcycles</b>          Antifurto per ciclomotori e motociclette          Diebstahlschutz für Motorfahrrad und Motorräder          Anti-vol pour cyclomoteurs et motocyclettes          Antihurto para ciclomotores y motocicletas          Anti-roubo para scooters e motocicletas</p>			

# THE CAR BOOK 4

## VEHICLES GUIDE LEGEND - LEGENDA GUIDA VEICOLI - AUTOSCHLÜSSEL ERLÄUTERUNG - LÉGENDE GUIDE VÉHICULES - LEYENDA GUÍA PARA VEHÍCULOS - LEGENDA GUIA PARA VEÍCULOS

<b>(1)</b>	<p>"PH" Transponder Philips*</p> <p>"PH / CR" Transponder Philips* Crypto</p> <p>"PH / CR2" Transponder Philips* Crypto 2</p> <p>"PH / CR3" Transponder Philips* Crypto 3</p> <p>"MEG" Transponder Megamos*</p> <p>"MEG / CR" Transponder Megamos* Crypto</p> <p>"SOK / CR" Sokymat* Crypto</p> <p>"TEXAS" Transponder Texas*</p> <p>"TEX / CR" Transponder Texas* Crypto</p> <p>"TEX / CR2" Transponder Texas* Crypto 2</p> <p>"TEX / MA" Transponder Texas* Crypto mutual authentication</p> <p>"Temic" Transponder Temic*</p> <p>"MOTOROLA" Transponder Motorola*</p> <p>"TEM / CR" Transponder Temic*Crypto</p> <p>"SAAB" Transponder Saab*</p>	<b>(2)</b>	<p><b>ID TRANSPONDER - FAST COPY PLUS / RW4 PLUS / FAST COPY / RW4</b></p> <p>48 Megamos* Crypto</p> <p>48-A Megamos* Crypto (Chevrolet - Daewoo)</p> <p>48-K Megamos* Crypto (Kia)</p> <p>49 Philips* Crypto 3</p> <p>50 Philips* Crypto 3</p> <p>53 Philips* (emulation of Megamos* for Audi*) (emulazione di Megamos* per Audi*) (simuliert Megamos* für Audi*) (émulation de Megamos* pour Audi*) (emulación de Megamos* para Audi*) (emulação de Megamos* para Audi*)</p> <p>73 Philips* (multi block - fixed code) (multi blocco - codice fisso) (multi block - Fixer Code) (multi bloc - code fixe) (multi bloque - código fijo) (multi bloco - código fixo)</p> <p>93 Philips* (emulation of Megamos* for Daewoo*) (emulazione di Megamos* per Daewoo*) (simuliert Megamos* für Daewoo*) (émulation de Megamos* pour Daewoo*) (emulación de Megamos* para Daewoo*) (emulação de Megamos* para Daewoo*)</p> <p>4C Texas* (fixed code) (codice fisso) (Fixer Code) (code fixe) (código fijo) (código fixo)</p> <p>4D Texas* Crypto</p> <p>4F Philips* Crypto (Fiat* - Alfa Romeo*)</p> <p>4M Philips* Crypto (Mitsubishi*)</p> <p>4W Philips* Crypto (VAG*)</p> <p>6A Texas* Crypto 3</p> <p>6E Texas* Crypto (with mutual authentication) (con mutua autenticazione) (mit gegenseitiger Authentisierung) (par authentication réciproque) (con autenticación mutua) (com autenticação mútua)</p> <p>6F Texas* Crypto 2</p> <p>8C Temic* Crypto</p> <p>8D Saab* (not duplicable) (non duplicabile) (nicht kopierbar) (non reproductible) (no duplicable) (não pode ser duplicado)</p> <p>8E Sokymat* Crypto</p> <p>A1 Megamos* Crypto Volkswagen*</p> <p>A2 Megamos* Crypto Audi*</p> <p>A3 Megamos* Crypto Seat*</p> <p>A4 Megamos* Crypto Skoda*</p>
<b>(2)</b>	<p><b>ID TRANSPONDER - FAST COPY PLUS / RW4 PLUS / FAST COPY / RW4</b></p> <p>11 Temic* (Fiat - fixed code) (Fiat - codice fisso) (Fiat - Fixer Code) (Fiat - code fixe) (Fiat - código fijo) (Fiat - código fixo)</p> <p>12 Temic* (Mazda - fixed code) (Mazda - codice fisso) (Mazda - Fixer Code) (Mazda - code fixe) (Mazda - código fijo) (Mazda - código fixo)</p> <p>13 Megamos* (fixed code) (codice fisso) (Fixer Code) (code fixe) (código fijo) (código fixo)</p> <p>17 Silca (fixed code - empty) (codice fisso - vuoto) (silca Fixer Code - leer) (fixe code - vide) (código fijo - vacío) (código fixo - vazio)</p> <p>21 Silca (fixed code - empty) (codice fisso - vuoto) (silca Fixer Code - leer) (fixe code - vide) (código fijo - vacío) (código fixo - vazio)</p> <p>22 Silca (fixed code - empty) (codice fisso - vuoto) (silca Fixer Code - leer) (fixe code - vide) (código fijo - vacío) (código fixo - vazio)</p> <p>23 Silca (fixed code - empty) (codice fisso - vuoto) (silca Fixer Code - leer) (fixe code - vide) (código fijo - vacío) (código fixo - vazio)</p> <p>33 Philips* (read/write - fixed code) (read/write - codice fisso) (read/write - Fixer Code) (read/write - code fixe) (read/write - código fijo) (read/write - código fixo)</p> <p>40 Philips* Crypto (Opel*-Vauxhall*)</p> <p>41 Philips* Crypto (Nissan*)</p> <p>42 Philips* Crypto (VAG*)</p> <p>44 Philips* Crypto</p> <p>45 Philips* Crypto (Peugeot*)</p> <p>46 Philips* Crypto 2</p> <p>47 Philips* Crypto 3</p>		

**(4) ID TRANSPONDER TEXAS CRYPTO (4D)**

- 60 Texas\* Crypto (generic) (generico) (nicht spezifiziert) (générique) (genérico) (genérico)
- 61 Texas\* Crypto Mitsubishi 3
- 62 Texas\* Crypto Mitsubishi 2
- 63 Texas\* Crypto Ford 2
- 64 Texas\* Crypto (Renault < 2000, Chrysler, Jeep)
- 65 Texas\* Crypto (Suzuki)
- 66 Texas\* Crypto (Suzuki 2)
- 67 Texas\* Crypto (Toyota / Lexus)
- 68 Texas\* Crypto (Toyota / Lexus 2)
- 69 Texas\* Crypto (Yamaha)
- 70 Texas\* Crypto (Toyota EU)
- 71 Texas\* Crypto (Suzuki Cycles)
- 72 Texas\* Crypto (Kawasaki Cycles)
- XX Texas\* Crypto (new or generic) (nuovo o generico) (neu oder nicht spezifiziert) (nouveau ou générique) (nuevo o genérico) (novo ou genérico)

- (5) "MEG"** Megamos\* (type of generation) (tipo di generazione) (Erzeugung Typ) (type de génération) (tipo de generación) (tipo de geração)
- "B - F"** Bosch\* - Fiat\* (type of generation) (tipo di generazione) (Erzeugung Typ) (type de génération) (tipo de generación) (tipo de geração)
- "S - O"** Siemens\* - Opel\* (type of generation) (tipo di generazione) (Erzeugung Typ) (type de génération) (tipo de generación) (tipo de geração)
- "M - V"** Megamos\* - VDO\* (type of generation) (tipo di generazione) (Erzeugung Typ) (type de génération) (tipo de generación) (tipo de geração)
- "T - F"** Temic\* - Fiat\* (type of generation) (tipo di generazione) (Erzeugung Typ) (type de génération) (tipo de generación) (tipo de geração)
- "S - V"** Siemens\* - Volkswagen\* (type of generation) (tipo di generazione) (Erzeugung Typ) (type de génération) (tipo de generación) (tipo de geração)
- "G - V"** PSA\* - Valeo\* (type of generation) (tipo di generazione) (Erzeugung Typ) (type de génération) (tipo de generación) (tipo de geração)
- "G - C"** PSA\* - CPH\* (type of generation) (tipo di generazione) (Erzeugung Typ) (type de génération) (tipo de generación) (tipo de geração)
- "N - N"** Nissan\* (type of generation) (tipo di generazione) (Erzeugung Typ) (type de génération) (tipo de generación) (tipo de geração)

The keys must then be memorized in the vehicle central immobilizer system.  
 Le chiavi devono poi essere memorizzate nella centralina immobilizer dell'auto.  
 Die Schlüssel müssen anschliessend in die Steuerzentrale der Wegfahrsperrung des Autos eingespeichert werden.  
 Les clés doivent être mises en mémoire dans le central immobiliseur du véhicule.  
 Las llaves deben memorizarse en la centralita immobilizer del vehículo.  
 A seguir as chaves devem ser memorizadas na central do sistema de imobilização do veículo.

**(\*) IMPORTANT NOTE**

The trade-marks or trade names mentioned in our catalogue are the exclusive property of authorized manufactures of lock and users, they are nominated only for the purposes of information so that any lock for which our keys are made can be rapidly identified.

I marchi o le denominazioni citate sono di proprietà esclusiva dei fabbricanti di serrature e degli utilizzatori autorizzati, e sono indicati a titolo di semplice informazione, con lo scopo di riconoscere velocemente a quali serrature le nostre chiavi sono destinate.

Die angeführten Markennamen oder Handelsmarken sind ausschließliches Eigentum der Schloßherteller und zugelassenen Fachhändlern, und sind nur zur Information angeführt, mit dem Zweck, schnell erkennen zu können, zu welchem Schloß unsere Schlüssel passen.

Les marques et appellations commerciales citées dans notre catalogue appartiennent exclusivement aux fabricants de serrures et aux utilisateurs autorisés, elles sont indiquées à titre d'information pure et simple pour vous permettre de déterminer rapidement les serrures auxquelles nos clés sont destinées.

Las marcas y denominaciones comerciales citadas en nuestro catálogo se declaran de propiedad exclusiva de los fabricantes de cerraduras y los utilizadores autorizados, se citan por simple información, al objeto de hacer comprender sin dificultad a qué cerraduras van destinadas nuestras llaves.

As marcas e as denominações citadas são propriedade exclusiva dos fabricantes de fechaduras e dos utilizadores autorizados, e são indicadas apenas a título de informação, a fim de reconhecer rapidamente as fechaduras a que se destinam as nossas chaves.



FOR:  
PER:

## ABARTH

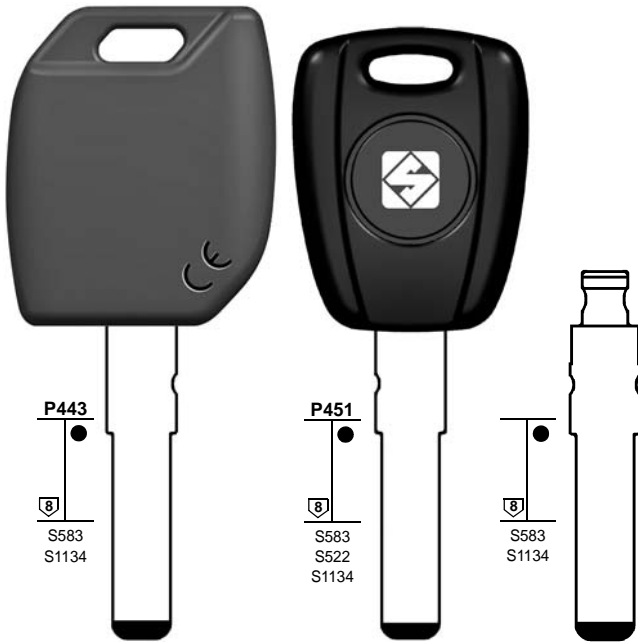

**SIP22MH**  
DE ..... 1-11210



**SIP22TE**  
DE ..... 1-11210



**SIP22FH**  
DE ..... 1-11210

GIOBERT - TRW SIPEA

GIOBERT - TRW SIPEA

## ACURA

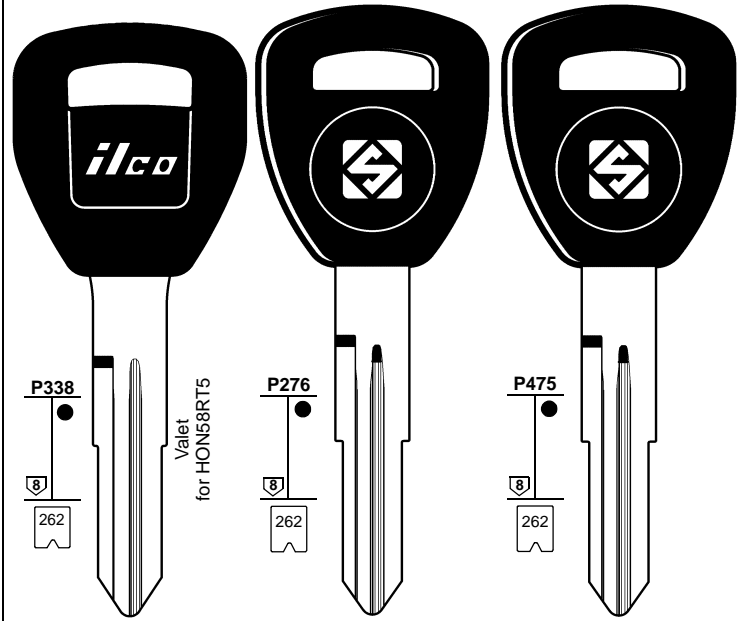

**HD107-PT5**  
..... 5001-8442



**HON58RT5**  
..... 5001-8442



**HON58RTE**  
..... 5001-8442

FOR:  
PER:

## ACURA

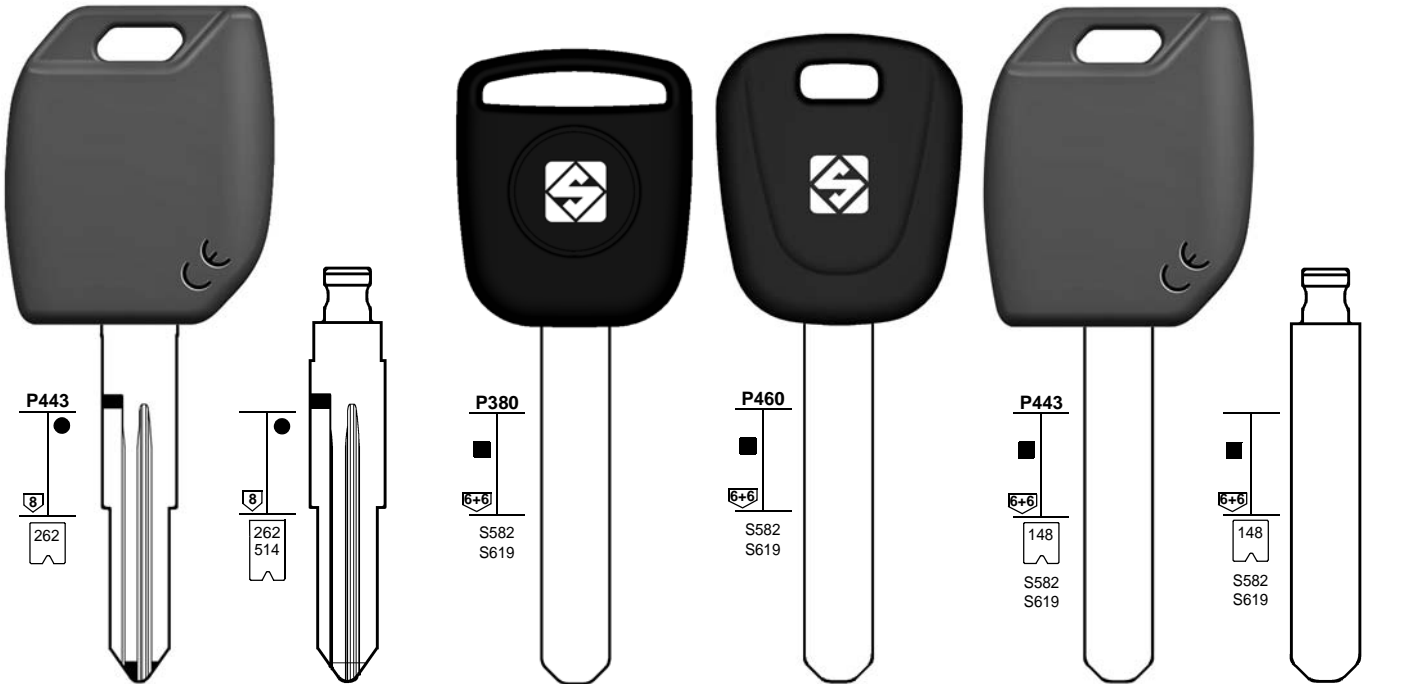

**HON58RMH**  
..... 5001-8442



**HON58RFH**  
..... 5001-8442  
..... 10001-15000



**HON66T5**  
..... (SUB) K001-N718  
..... (MAIN) K001-N718



**HON66TE**  
..... (SUB) K001-N718  
..... (MAIN) K001-N718



















**HON66MH**  
..... (SUB) K001-N718  
..... (MAIN) K001-N718  
..... 5001-8442



**HON66FH**  
..... (SUB) K001-N718  
..... (MAIN) K001-N718



**HON66T14**  
..... (SUB) K001-N718  
..... (MAIN) K001-N718  
..... 5001-8442

1	2	2a	3	3a	3b	e1+e2		6	42+71	72	43+44a	12	15
						GTI COMPATIBLE		IGNITION 					
CAR MAKE MODEL	FROM	TO	SILCA REF.	SILCA REF.	SILCA REF.	COPY	GEN.	TRANSP. TYPE	FAST COPY PLUS RW4 PLUS FAST COPY/RW4	FAST COPY PLUS RW4 PLUS	FAST COPY RW4	STP	
													
For more info on the uses of car keys, refer to the Silca Electronic Keys Catalogue: 													
<b>ABARTH</b>													
GRANDE PUNTO	2007	2010						PH / CR2	46				
GRANDE PUNTO	2007	2010	SIP22MH	SIP22TE	SIP22FH	Y		PH / CR2	46	Y	P-BOX		
PUNTO	2012							PH / CR2	46				
PUNTO	2012		SIP22MH	SIP22TE	SIP22FH	Y		PH / CR2	46	Y	P-BOX		
PUNTO EVO	2010	2012						PH / CR2	46				
PUNTO EVO	2010	2012	SIP22MH	SIP22TE	SIP22FH	Y		PH / CR2	46	Y	P-BOX		
500	2008							PH / CR2	46				
500	2008		SIP22MH	SIP22TE	SIP22FH	Y		PH / CR2	46	Y	P-BOX		
<b>ACURA</b>													
CL	1998	2003						MEG	13				
CL	1998	2003	HON58RT5		HON58RFH			MEG	13	Y	Y		
CL	1998	2003	HD107-PT5					MEG	13	Y	Y		
CSX	2006	2011	HON66T14					PH / CR2	46				
CSX	2006	2011	HON66MH	HON66TE	HON66FH	Y	Y	PH / CR2	46	Y	P-BOX		
EL	2001	2002	HON58RT5		HON58RFH			MEG	13	Y	Y		
EL	2001	2002						MEG	13				
EL	2003	2005	HON66T5		HON66FH			MEG	13	Y	Y		
EL	2003	2005						MEG	13				
ILX	2013		SMARTKEY					PH / CR2	46				
INTEGRA	2000	2001	HD107-PT5					MEG	13	Y	Y		
INTEGRA	2000	2001	HON58RT5		HON58RFH			MEG	13	Y	Y		
MDX	2001	2006	HD107-PT5					MEG	13	Y	Y		
MDX	2001	2006	HON58RT5		HON58RFH			MEG	13	Y	Y		
MDX	2007	2013	HON66T14					PH / CR2	46				
MDX	2007	2013	HON66MH	HON66TE	HON66FH	Y	Y	PH / CR2	46	Y	P-BOX		
MDX	2014		SMARTKEY					PH / CR2	46				
NSX	1997	2005	HD107-PT5					MEG	13	Y	Y	(Meg)	
NSX	1997	2005	HON58RT5		HON58RFH			MEG	13	Y	Y	(Meg)	
RDX	2007	2012	HON66T14					PH / CR2	46				
RDX	2007	2012	HON66MH	HON66TE	HON66FH	Y	Y	PH / CR2	46	Y	P-BOX		
RDX	2013		SMARTKEY					PH / CR2	46				
RL	1996	2004	HON58RT5		HON58RFH			MEG	13	Y	Y	(Meg)	
RL	1996	2004						MEG	13			(Meg)	
RL	1996	2004	HD107-PT5					MEG	13	Y	Y	(Meg)	
RL	2005	2010						PH / CR2	46				
RL	2005	2010	HON58RMH	HON58RTE	HON58RFH	Y	Y	PH / CR2	46	Y	P-BOX		
RLX	2014		SMARTKEY					PH / CR2	46				
RSX	2002	2006	HON58RT5		HON58RFH			MEG	13	Y	Y		
RSX	2002	2006	HD107-PT5					MEG	13	Y	Y		
RSX	2002	2006						MEG	13				
TL	1999	2003						MEG	13				
TL	1999	2003	HON58RT5		HON58RFH			MEG	13	Y	Y		
TL	1999	2003	HD107-PT5					MEG	13	Y	Y		
TL	2004	2006						PH / CR2	46				
TL	2004	2006	HON58RMH	HON58RTE	HON58RFH	Y	Y	PH / CR2	46	Y	P-BOX		
TL	2007		HON66T14					PH / CR2	46				

FOR:  
PER:

# ACURA

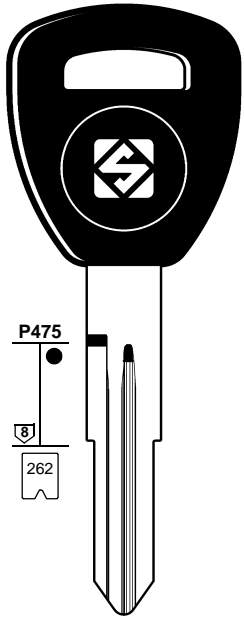

**HON58RTE**  
..... 5001-8442

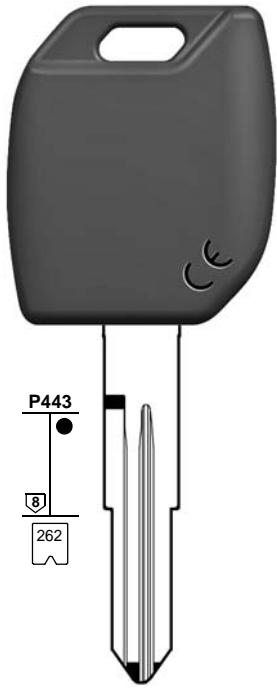

**HON58RMH**  
..... 5001-8442

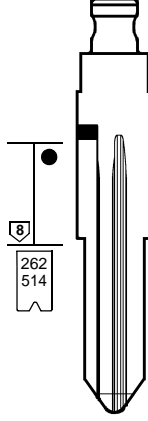

**HON58RFH**  
..... 5001-8442  
..... 10001-15000

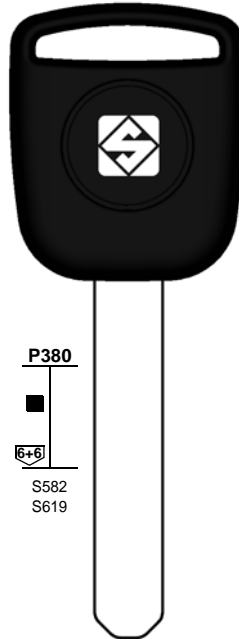

**HON66T14**  
..... (SUB) K001-N718  
..... (MAIN) K001-N718  
..... 5001-8442

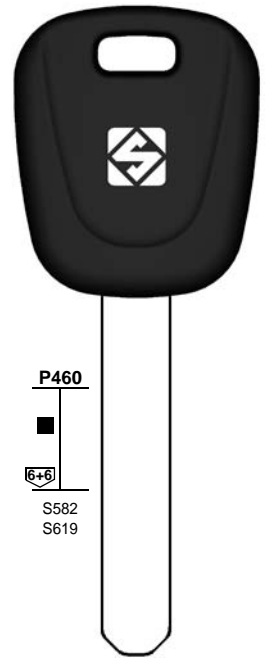

**HON66TE**  
..... (SUB) K001-N718  
..... (MAIN) K001-N718

FOR:  
PER:

# ACURA

# AIXAM (MICROCARS)

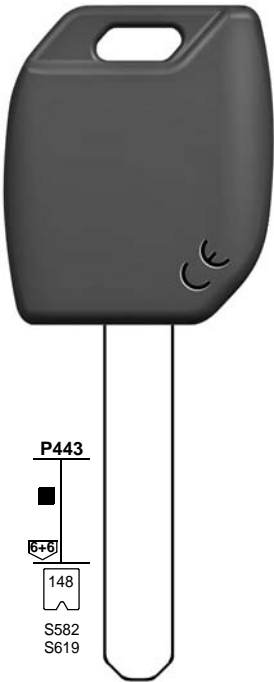

**HON66MH**  
..... (SUB) K001-N718  
..... (MAIN) K001-N718  
..... 5001-8442

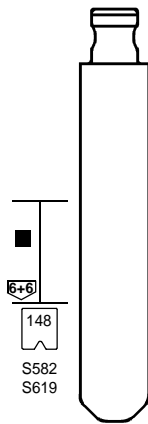

**HON66FH**  
..... (SUB) K001-N718  
..... (MAIN) K001-N718

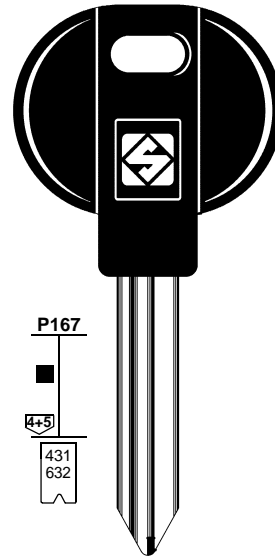

**SX9AP**  
63/99 ..... H 12468  
63/99 ..... 12468  
..... H 0111111-628888  
..... 0111111-628888



FOR:  
PER:

# ALFA ROMEO

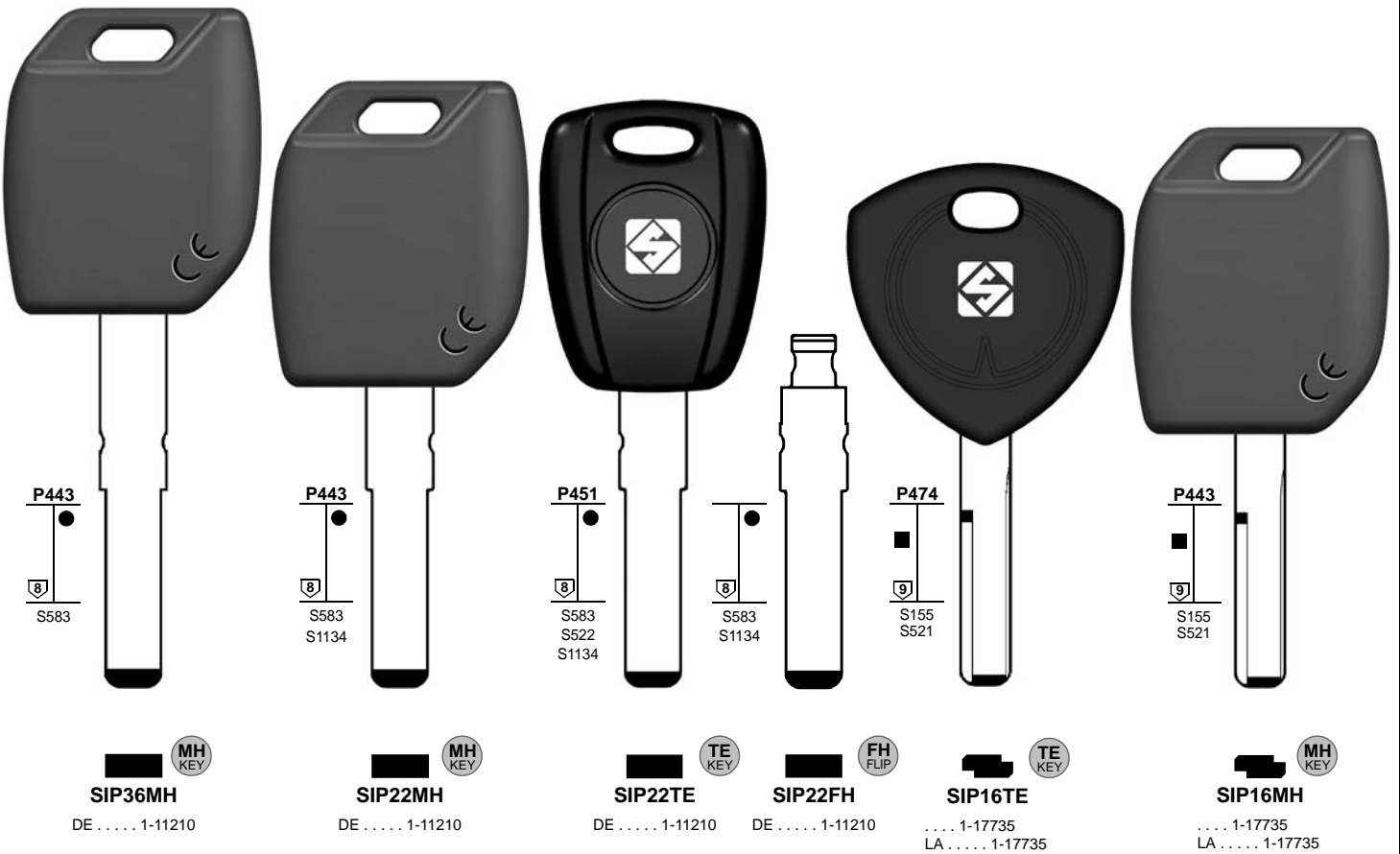

GIOBERT - TRW SIPEA

GIOBERT - TRW SIPEA

GIOBERT - TRW SIPEA

FOR:  
PER:

# ALFA ROMEO

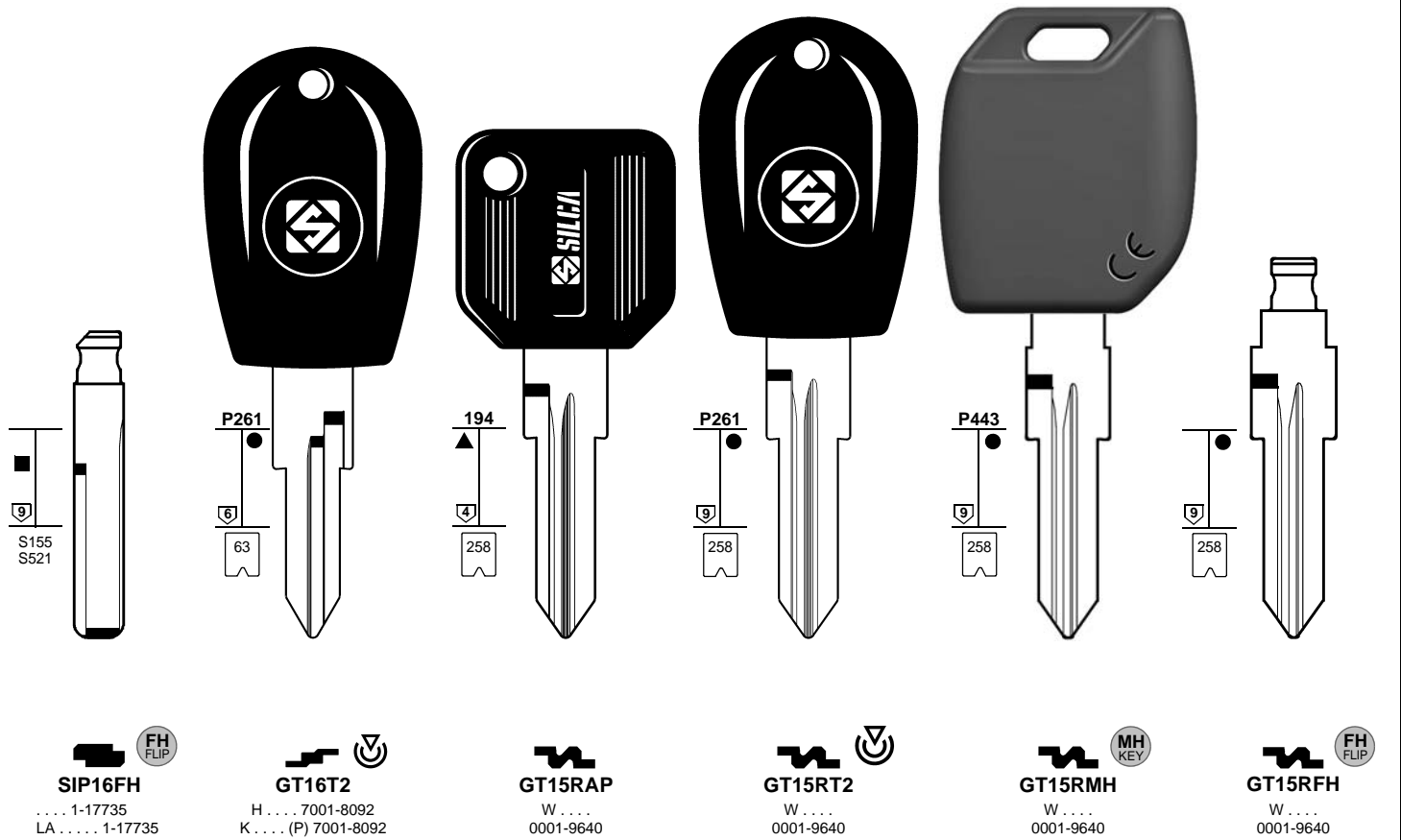

GIOBERT - TRW SIPEA

GIOBERT - TRW SIPEA

GIOBERT - TRW SIPEA





FOR:  
PER:

# ALFA ROMEO

# AUDI



P443  
258

**GT15RMH**  
W ....  
0001-9640

GIOBERT - TRW SIPEA

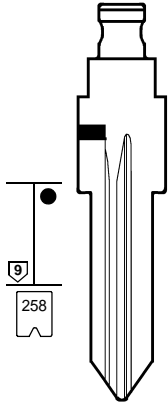

258

**GT15RFH**  
W ....  
0001-9640

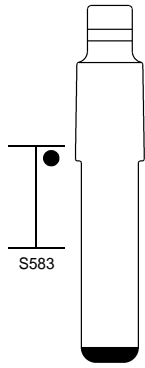

S583

**SIP18T**  
DE .....  
1-11210

GIOBERT - TRW SIPEA

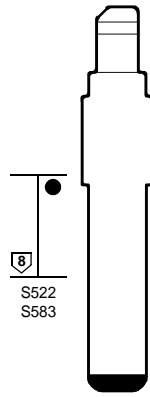

S522  
S583

**SIP29T**  
DE .....  
1-11210



P275  
49  
50

**HU49AT5**  
AH ..... 1-8154  
AH ..... 1001-9282

HUF - WITTE

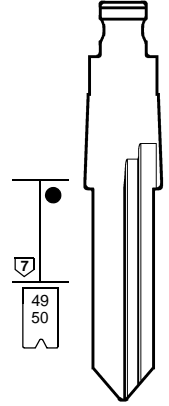

49  
50

**HU49FH**  
AH ..... 1-8154  
AH ..... 1001-9282

FOR:  
PER:

# AUDI



P275  
S102

**HU66AT5**  
.... 1-2000  
1ATS00001-17850

**HU66AT6**  
.... 1-2000  
1ATS00001-17850

HUF - WITTE



P254  
S102  
S260  
S482  
S832

**HU66TE**  
.... 1-2000  
.... 0001-6000

**HU66T6**  
.... 1-2000



P443  
S102  
S260





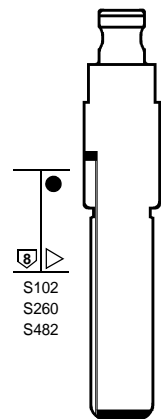











**HU66MH**  
.... 1-2000

HUF - WITTE



S102  
S260  
S482

**HU66FH**  
.... 1-2000  
.... 0001-6000

1	2	2a	3	3a	3b	e1+e2		6	42+71	72	43+44a	12	15
						<b>GTI COMPATIBLE</b>		<b>IGNITION</b> 					
<b>CAR MAKE MODEL</b>	FROM	TO	SILCA REF.	SILCA REF.	SILCA REF.	COPY	GEN.	TRANSP. TYPE	FAST COPY PLUS RW4 PLUS FAST COPY/RW4	FAST COPY PLUS RW4 PLUS	FAST COPY RW4	STP	
													
For more info on the uses of car keys, refer to the Silca Electronic Keys Catalogue: 													
<b>ALFA ROMEO</b>													
<b>SOME MODELS</b>	1995		<b>GT15RMH</b>		<b>GT15RFH</b>								
<b>SOME MODELS</b>	2000		<b>SIP18T</b>										
<b>SOME MODELS</b>	2005		<b>SIP29T</b>										
<b>AUDI</b>													
<b>80</b>	1996		<b>HU49AT5</b>		<b>HU49FH</b>			MEG	13	Y	Y	Meg	
<b>A1</b>	2010							MEG / CR	A2				
<b>A2</b>	2000	2005	<b>HU66AT6</b>		<b>HU66FH</b>			MEG / CR	48				
<b>A3</b>	1996	1997	<b>HU66AT5</b>		<b>HU66FH</b>			MEG	13	Y	Y	Meg	
<b>A3</b>	1997	2004	<b>HU66AT6</b>		<b>HU66FH</b>			MEG / CR	48				
<b>A3</b>	2004							MEG / CR	A2				
<b>A4</b>	1995	1996	<b>HU49AT5</b>		<b>HU49FH</b>			MEG	13	Y	Y	Meg	
<b>A4</b>	1996	1997	<b>HU66AT5</b>		<b>HU66FH</b>			MEG	13	Y	Y	Meg	
<b>A4</b>	1997	2004	<b>HU66AT6</b>		<b>HU66FH</b>			MEG / CR	48				
<b>A4</b>	2004							MEG / CR	A2				
<b>A6</b>	1995	1996	<b>HU49AT5</b>		<b>HU49FH</b>			MEG	13	Y	Y	Meg	
<b>A6</b>	1996	1997	<b>HU66AT5</b>		<b>HU66FH</b>			MEG	13	Y	Y	Meg	
<b>A6</b>	1997	2004	<b>HU66AT6</b>		<b>HU66FH</b>			MEG / CR	48				
<b>A6</b>	2004	2006						MEG / CR	A2				
<b>A6</b>	2006							SOK / CR	8E				
<b>A8</b>	1995	1996	<b>HU49AT5</b>		<b>HU49FH</b>			MEG	13	Y	Y	Meg	
<b>A8</b>	1996	1997	<b>HU66AT5</b>		<b>HU66FH</b>			MEG	13	Y	Y	Meg	
<b>A8</b>	1997	2004	<b>HU66AT6</b>		<b>HU66FH</b>			MEG / CR	48				
<b>A8</b>	2004							PH / CR2	46				
<b>A8</b>	2004		<b>HU66MH</b>	<b>HU66TE</b>	<b>HU66FH</b>	Y		PH / CR2	46	Y	P-BOX		
<b>ALLROAD</b>	2000	2005	<b>HU66AT6</b>		<b>HU66FH</b>			MEG / CR	48				
<b>ALLROAD</b>	2006							MEG / CR	A2				
<b>CABRIO</b>	1995	1996	<b>HU49AT5</b>		<b>HU49FH</b>			MEG	13	Y	Y	Meg	
<b>CABRIO</b>	1996	1997	<b>HU66AT5</b>		<b>HU66FH</b>			MEG	13	Y	Y	Meg	
<b>CABRIO</b>	1997		<b>HU66AT6</b>		<b>HU66FH</b>			MEG / CR	48				
<b>Coupè</b>	1995	1996	<b>HU49AT5</b>		<b>HU49FH</b>			MEG	13	Y	Y	Meg	
<b>Coupè</b>	1996	1997	<b>HU66AT5</b>		<b>HU66FH</b>			MEG	13	Y	Y	Meg	
<b>Coupè</b>	1997		<b>HU66AT6</b>		<b>HU66FH</b>			MEG / CR	48				
<b>Coupè S2</b>	1995	1996	<b>HU49AT5</b>		<b>HU49FH</b>			MEG	13	Y	Y	Meg	
<b>Coupè S2</b>	1996	1997	<b>HU66AT5</b>		<b>HU66FH</b>			MEG	13	Y	Y	Meg	
<b>Coupè S2</b>	1997		<b>HU66AT6</b>		<b>HU66FH</b>			MEG / CR	48				
<b>Q7</b>	2006							PH / CR2	46				
<b>Q7</b>	2006		<b>HU66MH</b>					PH / CR2	46	Y	P-BOX		
<b>S3</b>	2001	2004	<b>HU66AT6</b>		<b>HU66FH</b>			MEG / CR	48				
<b>S4</b>	2002	2005	<b>HU66T6</b>		<b>HU66FH</b>			MEG / CR	48				
<b>S6</b>	1995	1996	<b>HU49AT5</b>		<b>HU49FH</b>			MEG	13	Y	Y	Meg	
<b>S6</b>	1996	1997	<b>HU66AT5</b>		<b>HU66FH</b>			MEG	13	Y	Y	Meg	
<b>S6</b>	1997		<b>HU66AT6</b>		<b>HU66FH</b>			MEG / CR	48				
<b>S8</b>	1998		<b>HU66AT6</b>		<b>HU66FH</b>			MEG / CR	48				
<b>TT</b>	1998	2004	<b>HU66AT6</b>		<b>HU66FH</b>			MEG / CR	48				
<b>TT</b>	2004							MEG / CR	A2				

FOR:  
PER:

# BELLIER (MICROCARS)

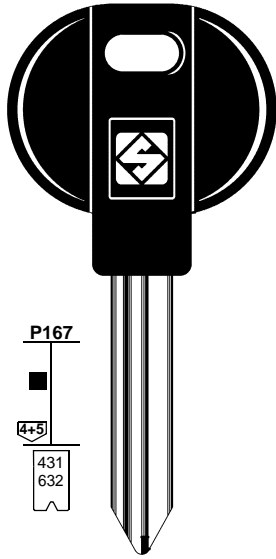

P167  
■  
4+5  
431  
632



**SX9AP**

63/99 . . . . . H 12468  
63/99 . . . . . 12468  
. . . . . H 0111111-6288888  
. . . . . 0111111-6288888

# BMW



P387  
■  
S574

**HU92RKP**

The HU92RKP key can be also purchased in 5-piece packages.  
*La chiave HU92RKP può essere acquistata anche in confezioni da 5 pezzi.*  
Der Schlüssel HU92RKP kann auch in Pakungen mit 5 Stücke gekauft werden.  
*La clé HU92RKP peut même être commandée sous confection de 5 pcs.*  
La llave HU92RKP se puede comprar en paquetes de 5 piezas.  
*As chaves HU92RKP podem ser compradas em pacotes de 5 unidades.*

**HU92RTEK**   
(old HU92RMHK Reference)

FOR:  
PER:

# BMW

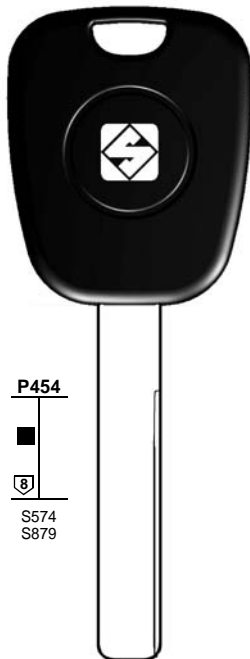

P454  
■  
8  
S574  
S879



**HU92RTE**  
. . . . . 1-8100

HUF - WITTE

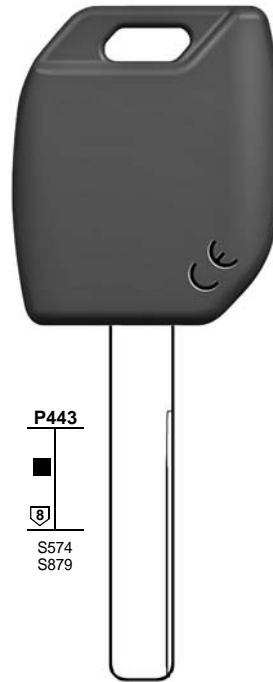

P443  
■  
8  
S574  
S879



**HU92RMH**  
. . . . . 1-8100

HUF - WITTE



1	2	2a	3	3a	3b	e1+e2		6	42+71	72	43+44a	12	15
						<b>GTI COMPATIBLE</b>		<b>IGNITION</b> 					
<b>CAR MAKE MODEL</b>	<b>FROM</b>	<b>TO</b>	<b>SILCA REF.</b>	<b>SILCA REF.</b>	<b>SILCA REF.</b>	<b>COPY</b>	<b>GEN.</b>	<b>TRANSP. TYPE</b>	<b>FAST COPY PLUS RW4 PLUS FAST COPY/RW4</b>	<b>FAST COPY PLUS RW4 PLUS</b>	<b>FAST COPY RW4</b>	<b>STP</b>	
For more info on the uses of car keys, refer to the Silca Electronic Keys Catalogue:													
<b>BELLIER (MICROCARS)</b>													
<b>DIVANE</b>	2004	2006	<b>SX9AP</b>										
<b>JADE</b>	2009		<b>SX9AP</b>										
<b>OPALE</b>	2007	2009	<b>SX9AP</b>										
<b>BMW</b>													
<b>MINI</b>	2001	2006						PH	73				
<b>MINI</b>	2007							PH / CR2	46				
<b>SERIE 1</b>	2004							PH / CR2	46				
<b>SERIE 1</b>	2004	2011	<b>HU92RMHK</b>					PH / CR2	46	Y	P-BOX		
<b>SERIE 1</b>	2004	2011	<b>HU92RTEK</b>					PH / CR2	46	Y	P-BOX		
<b>SERIE 1</b>	2004	2011	<b>HU92RMH</b>	<b>HU92RTE</b>		Y		PH / CR2	46	Y	P-BOX		
<b>SERIE 3</b>	1995	2001						PH	33				
<b>SERIE 3</b>	2002	2006						PH	73				
<b>SERIE 3</b>	2005							PH / CR2	46				
<b>SERIE 3</b>	2005	2011	<b>HU92RMHK</b>					PH / CR2	46	Y	P-BOX		
<b>SERIE 3</b>	2005	2011	<b>HU92RTEK</b>					PH / CR2	46	Y	P-BOX		
<b>SERIE 3</b>	2005	2011	<b>HU92RMH</b>	<b>HU92RTE</b>		Y		PH / CR2	46	Y	P-BOX		
<b>SERIE 5</b>	1996	2003						PH	33				
<b>SERIE 5</b>	2003	2010						PH / CR2	46				
<b>SERIE 5</b>	2003	2010	<b>HU92RMHK</b>					PH / CR2	46	Y	P-BOX		
<b>SERIE 5</b>	2003	2010	<b>HU92RTEK</b>					PH / CR2	46	Y	P-BOX		
<b>SERIE 5</b>	2003	2010	<b>HU92RMH</b>	<b>HU92RTE</b>		Y		PH / CR2	46	Y	P-BOX		
<b>SERIE 6</b>	2004							PH / CR2	46				
<b>SERIE 6</b>	2004	2011	<b>HU92RMHK</b>					PH / CR2	46	Y	P-BOX		
<b>SERIE 6</b>	2004	2011	<b>HU92RTEK</b>					PH / CR2	46	Y	P-BOX		
<b>SERIE 6</b>	2004	2011	<b>HU92RMH</b>	<b>HU92RTE</b>		Y		PH / CR2	46	Y	P-BOX		
<b>SERIE 7</b>	1994	2001						PH	33				
<b>SERIE 7</b>	2002	2008						PH / CR2	46				
<b>SERIE 7</b>	2002	2008	<b>HU92RMH</b>	<b>HU92RTE</b>		Y		PH / CR2	46	Y	P-BOX		
<b>SERIE 8</b>	1995	1999						PH	33				
<b>X3</b>	2003							PH	73				
<b>X5</b>	1999	2003						PH	33				
<b>X5</b>	2004							PH / CR2	46				
<b>X5</b>	2004	2011	<b>HU92RMHK</b>					PH / CR2	46	Y	P-BOX		
<b>X5</b>	2004	2011	<b>HU92RTEK</b>					PH / CR2	46	Y	P-BOX		
<b>X5</b>	2004	2011	<b>HU92RMH</b>			Y		PH / CR2	46	Y	P-BOX		
<b>Z3</b>	1995	2002						PH	33				
<b>Z4</b>	2002	2006						PH	73				
<b>Z4</b>	2006							PH / CR2	46				
<b>Z4</b>	2006	2011	<b>HU92RMH</b>	<b>HU92RTE</b>		Y		PH / CR2	46	Y	P-BOX		
<b>Z4</b>	2006	2011	<b>HU92RMHK</b>					PH / CR2	46	Y	P-BOX		
<b>Z4</b>	2006	2011	<b>HU92RTEK</b>					PH / CR2	46	Y	P-BOX		
<b>Z8</b>	2000	2003						PH	73				

FOR:  
PER:

# BUICK

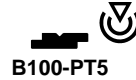
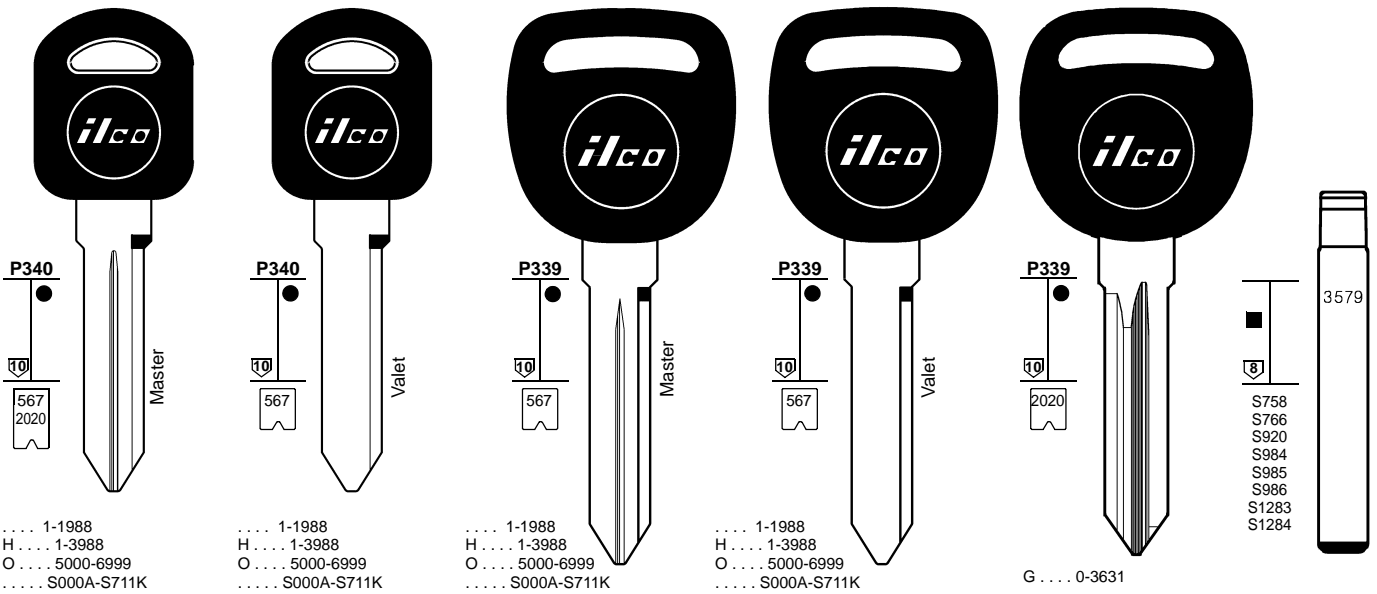

Z.....1-2000  
 Z..... 2001-4000  
 Z..... 4001-6000  
 ..... 0001-3679

BRIGGS & STRATTON

BRIGGS & STRATTON

BRIGGS & STRATTON

HUF - VALEO

FOR:  
PER:

# BUICK

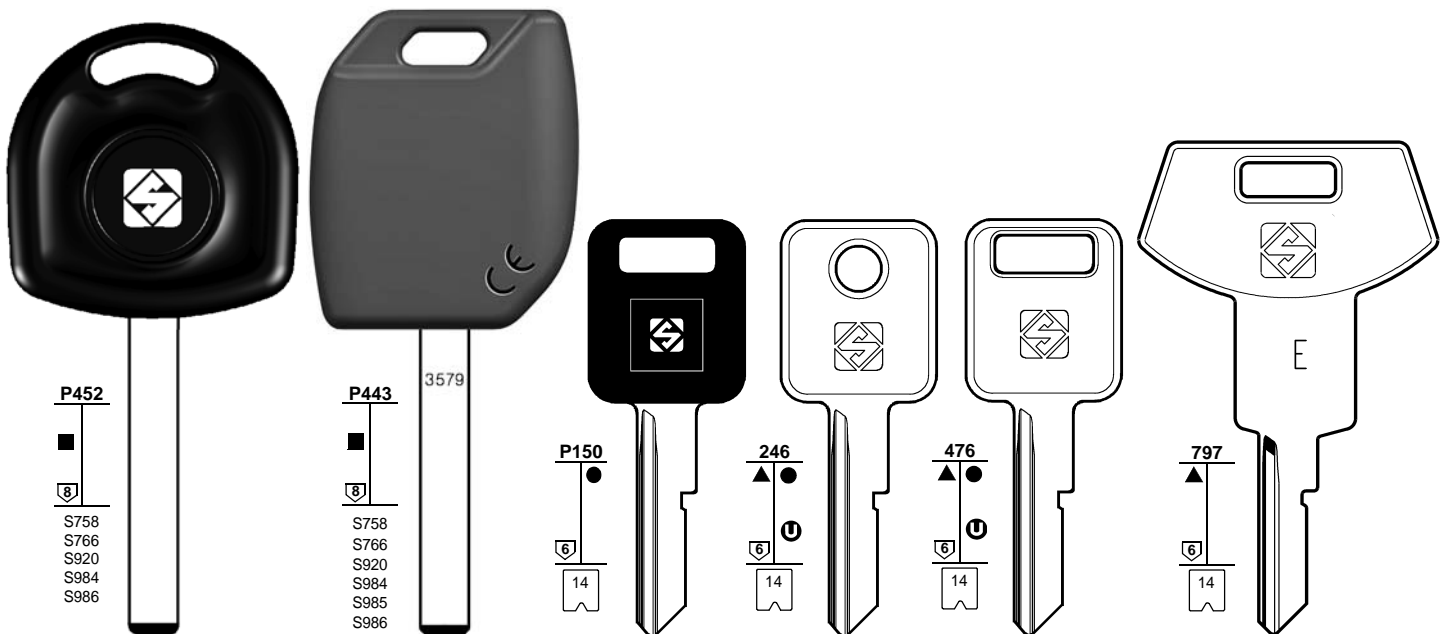

Z.....1-2000  
 Z..... 2001-4000  
 Z..... 4001-6000

Z..... 1-2000  
 Z..... 2001-4000  
 Z..... 4001-6000

E  
 .. J .. 0.00-9.99  
 .. J .. 00.0-99.9  
 .. K .. 0.00-9.99  
 .. K .. 00.0-99.9  
 N ... 000-999  
 P ... 000-999

E  
 .. J .. 0.00-9.99  
 .. J .. 00.0-99.9  
 .. K .. 0.00-9.99  
 .. K .. 00.0-99.9  
 N ... 000-999  
 P ... 000-999

E  
 .. J .. 0.00-9.99  
 .. J .. 00.0-99.9  
 .. K .. 0.00-9.99  
 .. K .. 00.0-99.9  
 N ... 000-999  
 P ... 000-999

.. K. (E) 00.0-99.9  
 .. J. (E) 00.0-99.9

HUF - VALEO

H ..L.00.0-99.9

H ..L.00.0-99.9

H ..L.00.0-99.9

1	2	2a	3	3a	3b	e1+e2	6	42+71	72	43+44a	12	15	
						GTI COMPATIBLE	IGNITION 						
CAR MAKE MODEL	FROM	TO	SILCA REF.	SILCA REF.	SILCA REF.	COPY	GEN.	TRANSP. TYPE	FAST COPY PLUS RW4 PLUS FAST COPY/RW4	FAST COPY PLUS RW4 PLUS	FAST COPY RW4	STP	
For more info on the uses of car keys, refer to the Silca Electronic Keys Catalogue:													
<b>BUICK</b>													
ALLURE	2005	2009						MEG	13				G
ALLURE	2010	2012	HU100MH	HU100TE	HU100FH	Y		PH / CR2	46	Y	P-BOX		
CENTURY	1991	2000	GM5-OR										
CENTURY	1991	2000	GM5-OR										
CENTURY	1991	2000	GM5CP										
CENTURY	1991	2000	GM5CP										
CENTURY	2000	2005	B97-PT5					MEG	13	Y	Y		
ENCLAVE	2007		B111-PT					PH / CR2	46				
LACROSSE	2005	2009						MEG	13				G
LACROSSE	2010		HU100MH	HU100TE	HU100FH	Y		PH / CR2	46	Y	P-BOX		
LACROSSE	2010							PH / CR2	46				
LESABRE	1992	1999						VATS SYS.					
LESABRE	2000	2005	B99-PT					MEG	13				A
LESABRE	2000	2005	B100-PT					MEG	13				A
LESABRE	2000	2005	B100-PT5					MEG	13	Y	Y		
LESABRE	2000	2005	B99-PT5					MEG	13	Y	Y		
LUCERNE	2006	2011	B111-PT					PH / CR2	46				
PARK AVENUE	1991	1996						VATS SYS.					
PARK AVENUE	1991	1996						VATS SYS.					
PARK AVENUE	1997	2002	B98-PT5					MEG	13	Y	Y		
PARK AVENUE	1997	2002	B97-PT5					MEG	13	Y	Y		
PARK AVENUE	1997	2002	B98-PT					MEG	13				A
PARK AVENUE	1997	2002	B97-PT					MEG	13				A
PARK AVENUE	2003	2005	B97-PT					MEG	13				A
PARK AVENUE	2003	2005	B97-PT					MEG	13				G
PARK AVENUE	2003	2005	B97-PT5					MEG	13	Y	Y		
RAINIER	2003	2007	B99-PT5					MEG	13	Y	Y		
RAINIER	2003	2007	B100-PT5					MEG	13	Y	Y		
RAINIER	2003	2007	B100-PT					MEG	13				A
RAINIER	2003	2007	B99-PT					MEG	13				A
RAINIER	2003	2007	B99-PT					MEG	13				G
RAINIER	2003	2007	B100-PT					MEG	13				G
REGAL	1991	1993	GM27R										
REGAL	1994	1996						VATS SYS.					
REGAL	1997	2004						VATS SYS.					
REGAL	2011							PH / CR2	46				
REGAL	2011		HU100MH	HU100TE	HU100FH	Y		PH / CR2	46	Y	P-BOX		
RENDEZVOUS	2002	2007	B99-PT5					MEG	13	Y	Y		
RENDEZVOUS	2002	2007	B100-PT5					MEG	13	Y	Y		
RENDEZVOUS	2002	2007	B99-PT					MEG	13				A
RENDEZVOUS	2002	2007	B100-PT					MEG	13				A
RIVIERA	1992	1994						VATS SYS.					
RIVIERA	1995	1999						VATS SYS.					
ROADMASTER	1991	1993	GM5										
ROADMASTER	1994	1996						VATS SYS.					
SIGNA	2005	2007											

FOR:  
PER:

# BUICK

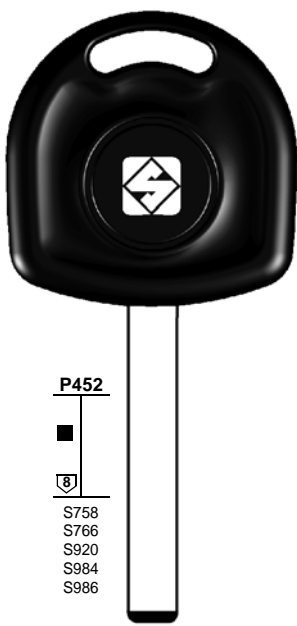

P452

S758  
S766  
S920  
S984  
S985  
S986



**HU100TE**

Z ..... 1-2000  
Z ..... 2001-4000  
Z ..... 4001-6000

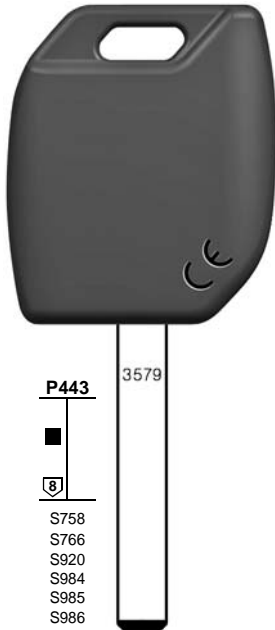

P443

3579

S758  
S766  
S920  
S984  
S985  
S986



**HU100MH**

Z ..... 1-2000  
Z ..... 2001-4000  
Z ..... 4001-6000

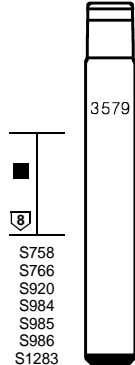

P443

3579

S758  
S766  
S920  
S984  
S985  
S986  
S1283  
S1284



**HU100FH**

Z ..... 1-2000  
Z ..... 2001-4000  
Z ..... 4001-6000  
..... 0001-3679

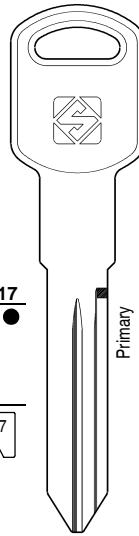

P1017

567

Primary



**GM39**

..... AA00-7T51  
..... S000A-S711K

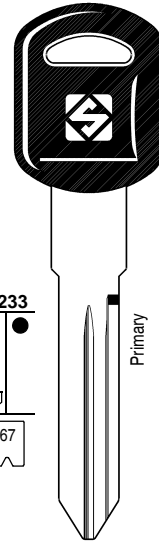

P233

567

Primary



**GM39EP**

..... AA00-7T51  
..... S000A-S711K

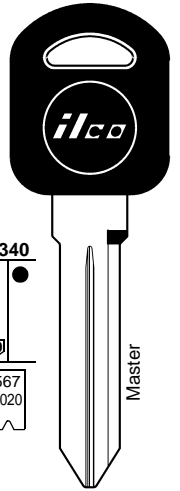

P340

567  
2020

Master

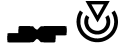

**B97-PT**

G ..... 0-3631  
..... 1-1988  
..... S000A-S711K

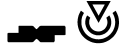

**B97-PT5**

..... 1-1988  
H ..... 1-3988  
..... S000A-S711K

HUF - VALEO

HUF - VALEO

BRIGGS & STRATTON

FOR:  
PER:

# CADILLAC

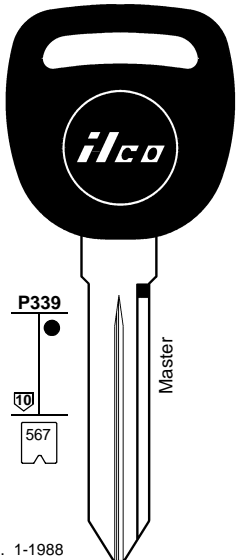

P339

567

Master

..... 1-1988  
H ..... 1-3988  
O ..... 5000-6999  
..... S000A-S711K



**B99-PT**

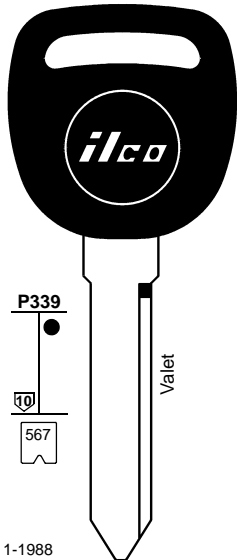

P339

567

Valet

..... 1-1988  
H ..... 1-3988  
O ..... 5000-6999  
..... S000A-S711K



**B100-PT**

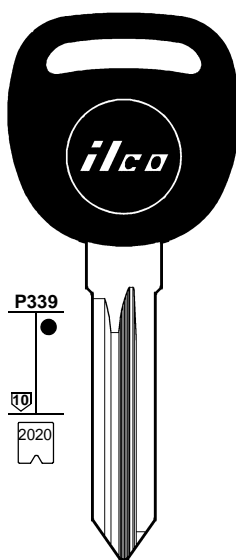

P339

2020

G ..... 0-3631



**B111-PT**

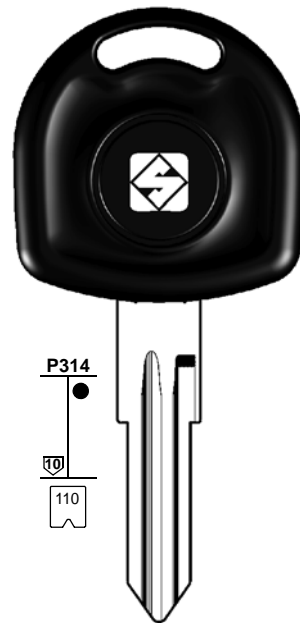

P314

110

S ..... 5298-6300  
S ..... 1-5200



**HU46T2**

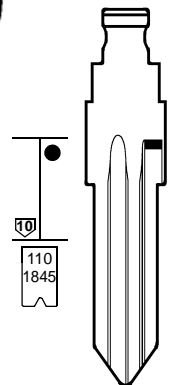

110  
1845

S ..... 5298-6300  
S ..... 1-5200



**HU46FH**



**B99-PT5**



**B100-PT5**

BRIGGS & STRATTON

BRIGGS & STRATTON





FOR:  
PER:

# CADILLAC

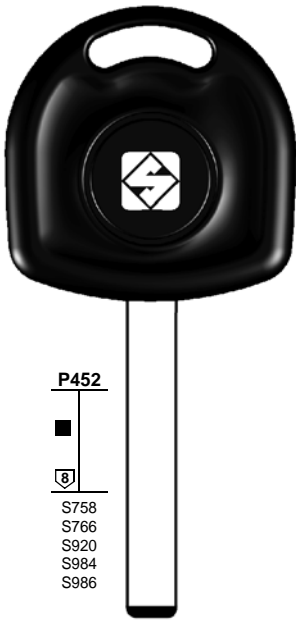

P452



S758  
S766  
S920  
S984  
S986



**HU100TE**

Z . . . . 1-2000  
Z . . . . 2001-4000  
Z . . . . 4001-6000

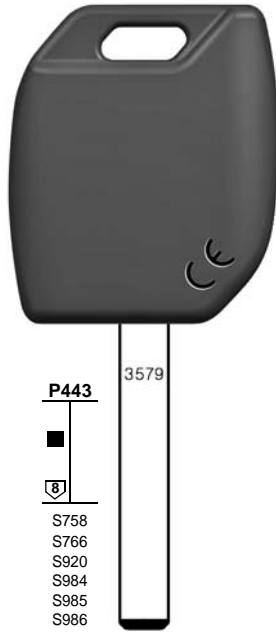

P443



S758  
S766  
S920  
S984  
S985  
S986  
S986



**HU100MH**

Z . . . . 1-2000  
Z . . . . 2001-4000  
Z . . . . 4001-6000

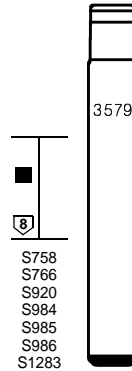

P443



S758  
S766  
S920  
S984  
S985  
S986  
S1283  
S1284



**HU100FH**

Z . . . . 1-2000  
Z . . . . 2001-4000  
Z . . . . 4001-6000  
. . . . . 0001-3679

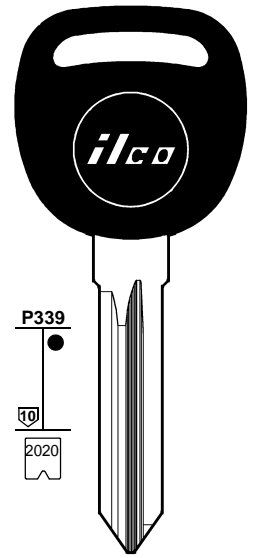

P339



2020



**B111-PT**

G . . . . 0-3631

HUF - VALEO

HUF - VALEO

BRIGGS & STRATTON

FOR:  
PER:

# CHATENET (MICROCARS)

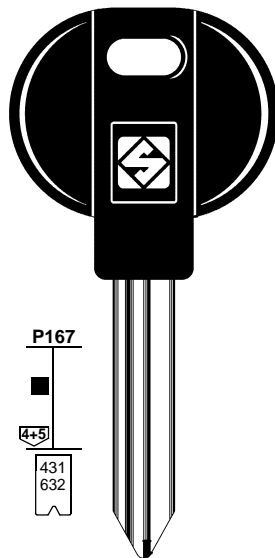

P167



431  
632



**SX9AP**

63/99 . . . . H 12468  
63/99 . . . . 12468  
. . . . . H 0111111-628888  
. . . . . 0111111-628888



FOR:  
PER:

# CHEVROLET SUD AMERICA



P452

■  
8  
S758  
S766  
S920  
S984  
S986



**HU100TE**

Z . . . . 1-2000  
Z . . . . 2001-4000  
Z . . . . 4001-6000



P443

3579  
■  
8  
S758  
S766  
S920  
S984  
S985  
S986



**HU100MH**

Z . . . . 1-2000  
Z . . . . 2001-4000  
Z . . . . 4001-6000

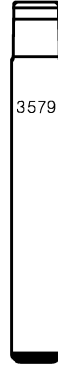

3579  
■  
8  
S758  
S766  
S920  
S984  
S985  
S986  
S1283  
S1284



**HU100FH**

Z . . . . 1-2000  
Z . . . . 2001-4000  
Z . . . . 4001-6000  
. . . . 0001-3679



P314

110

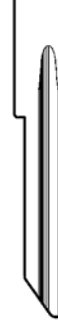

**HU46T12**

S . . . . 1-5200  
S . . . . 5298-6300



110  
1845



**HU46FH**

S . . . . 5298-6300  
S . . . . 1-5200



**HU46T2**

S . . . . 1-5200  
S . . . . 5298-6300

HUF - VALEO

HUF - VALEO

HUF - WITTE

FOR:  
PER:

# CHEVROLET SUD AMERICA



P445

110  
1845

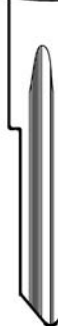

**HU160GP**

S . . . . 1-5200  
S . . . . 5298-6300

HUF - VALEO



P444

110  
1426  
1844



**YM28CP**

D . . . . 1-5200  
S . . . . 1-5200  
S . . . . 5298-6300  
. . . . 1002-3997  
. . . . 4000-5874

YMOS



P314

110  
1426



**YM28T2**

D . . . . 1-5200  
S . . . . 1-5200  
S . . . . 5298-6300  
. . . . 1002-3997  
. . . . 4000-5874

YMOS

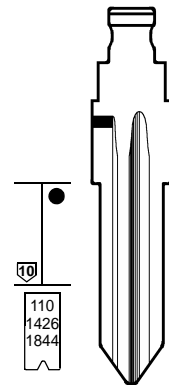

110  
1426  
1844

**YM28FH**

D . . . . 1-5200  
. . . . 1002-3997  
. . . . 4000-5874  
D . . . . 1-5200

VALEO - YMOS



FOR:  
PER:

# CHEVROLET SUD AMERICA



**HU46T12**  
S . . . . 1-5200  
S . . . . 5298-6300



**HU46BT12**  
S . . . . 1-5200  
S . . . . 5298-6300

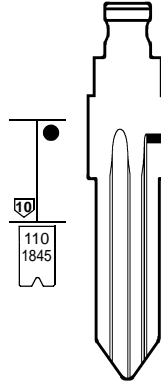

**HU46FH**  
S . . . . 1-5200  
S . . . . 5298-6300

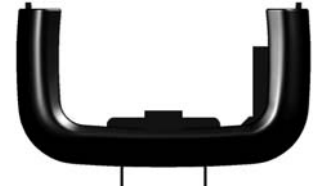

**HU46AT9**  
S . . . . 1-5200  
S . . . . 5298-6300



**HU46T2**  
S . . . . 1-5200  
S . . . . 5298-6300



**HU46T9**  
S . . . . 1-5200  
S . . . . 5298-6300

HUF

HUF

HUF

FOR:  
PER:

# CHEVROLET SUD AMERICA



**YM28T2**  
D . . . . 1-5200  
S . . . . 1-5200  
S . . . . 5298-6300  
S . . . . 1002-3997  
S . . . . 4000-5874



**YM28AT9**  
D . . . . 1-5200  
S . . . . 1-5200  
S . . . . 5298-6300  
S . . . . 1002-3997  
S . . . . 4000-5874

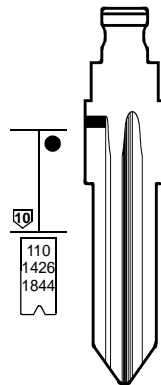

**YM28FH**  
D . . . . 1-5200  
S . . . . 1002-3997  
S . . . . 4000-5874  
D . . . . 1-5200

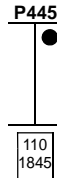

**HU160GP**  
S . . . . 1-5200  
S . . . . 5298-6300

VALEO - YMOS

VALEO - YMOS

HUF





FOR:  
PER:

# CHEVROLET SUD AMERICA

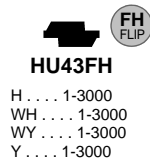
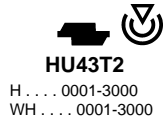
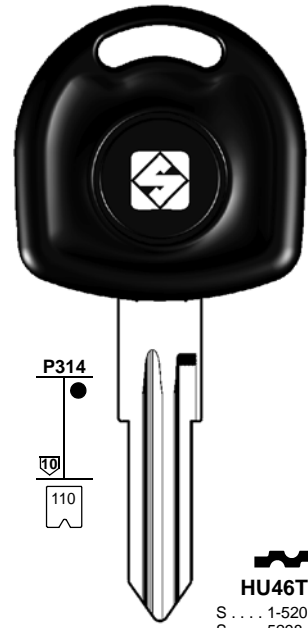
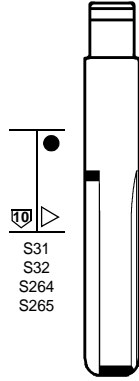
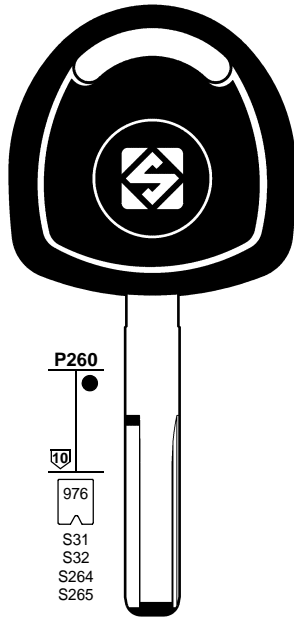
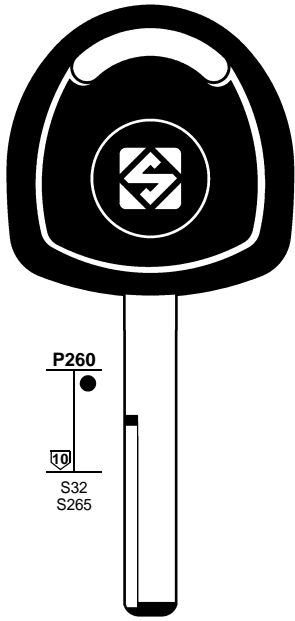

YMOS

HUF - YMOS

HUF

FOR:  
PER:

# CHEVROLET SUD AMERICA

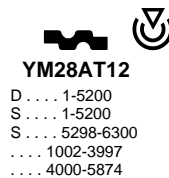
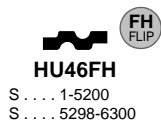
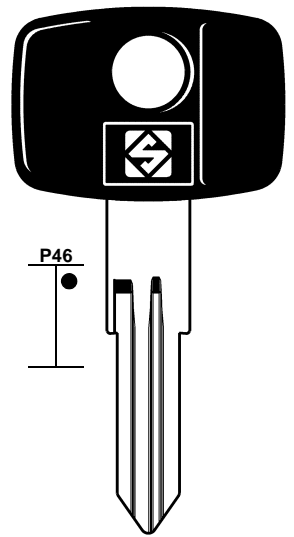
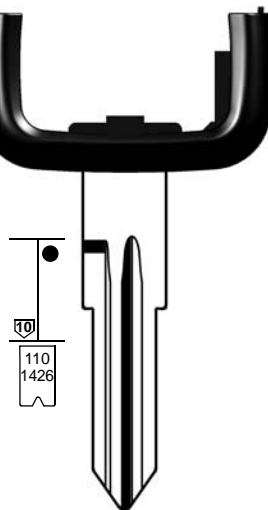
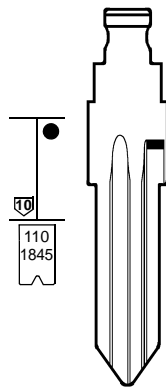
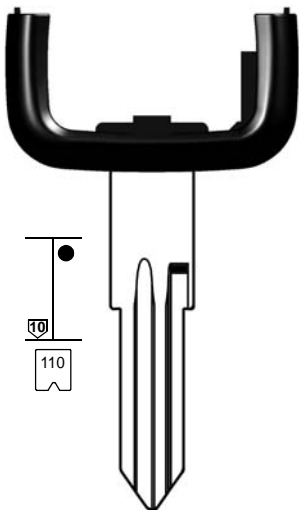

HUF

YMOS



FOR:  
PER:

# CHEVROLET USA

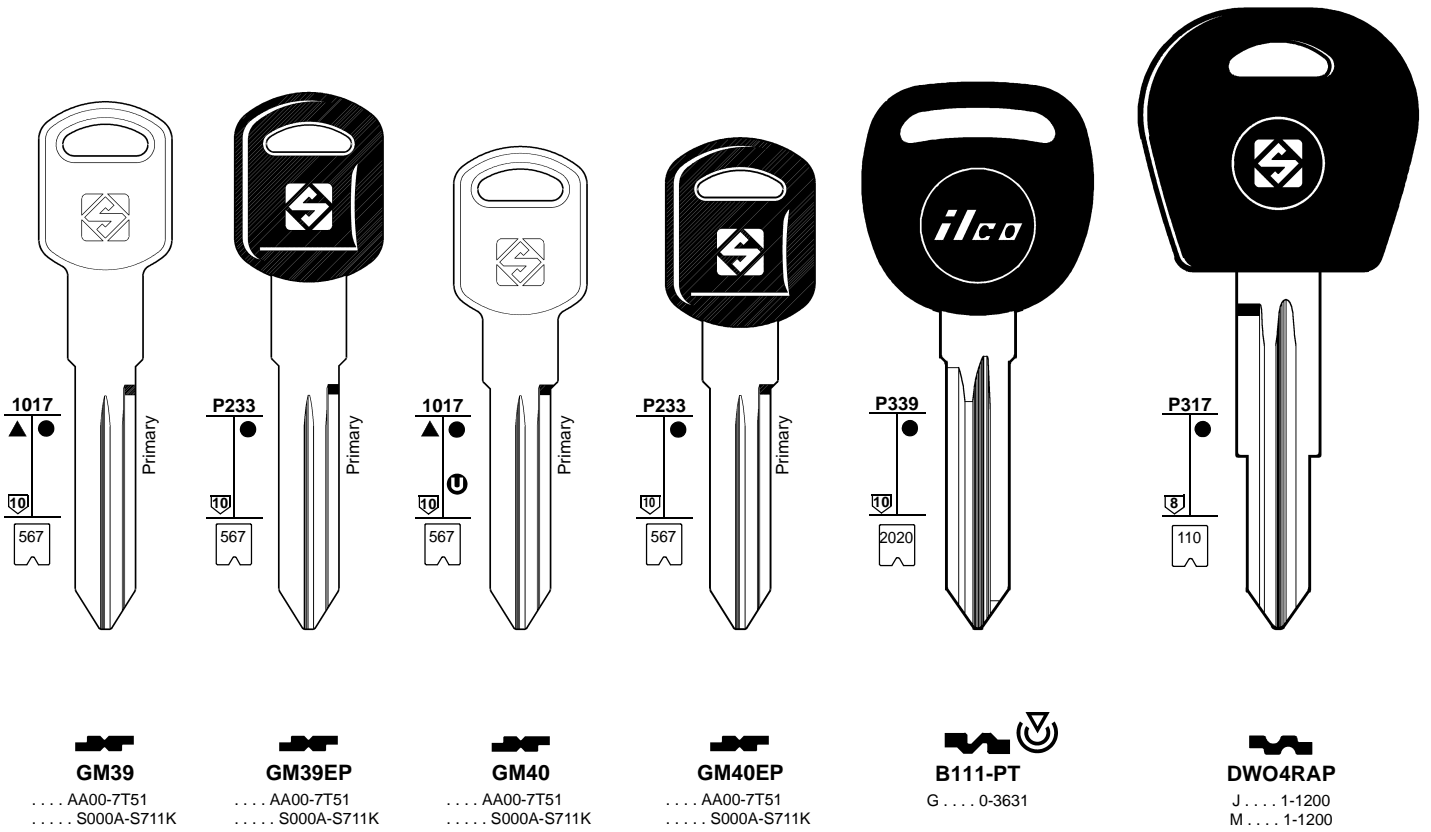

BRIGGS & STRATTON

BRIGGS & STRATTON

FOR:  
PER:

# CHEVROLET USA

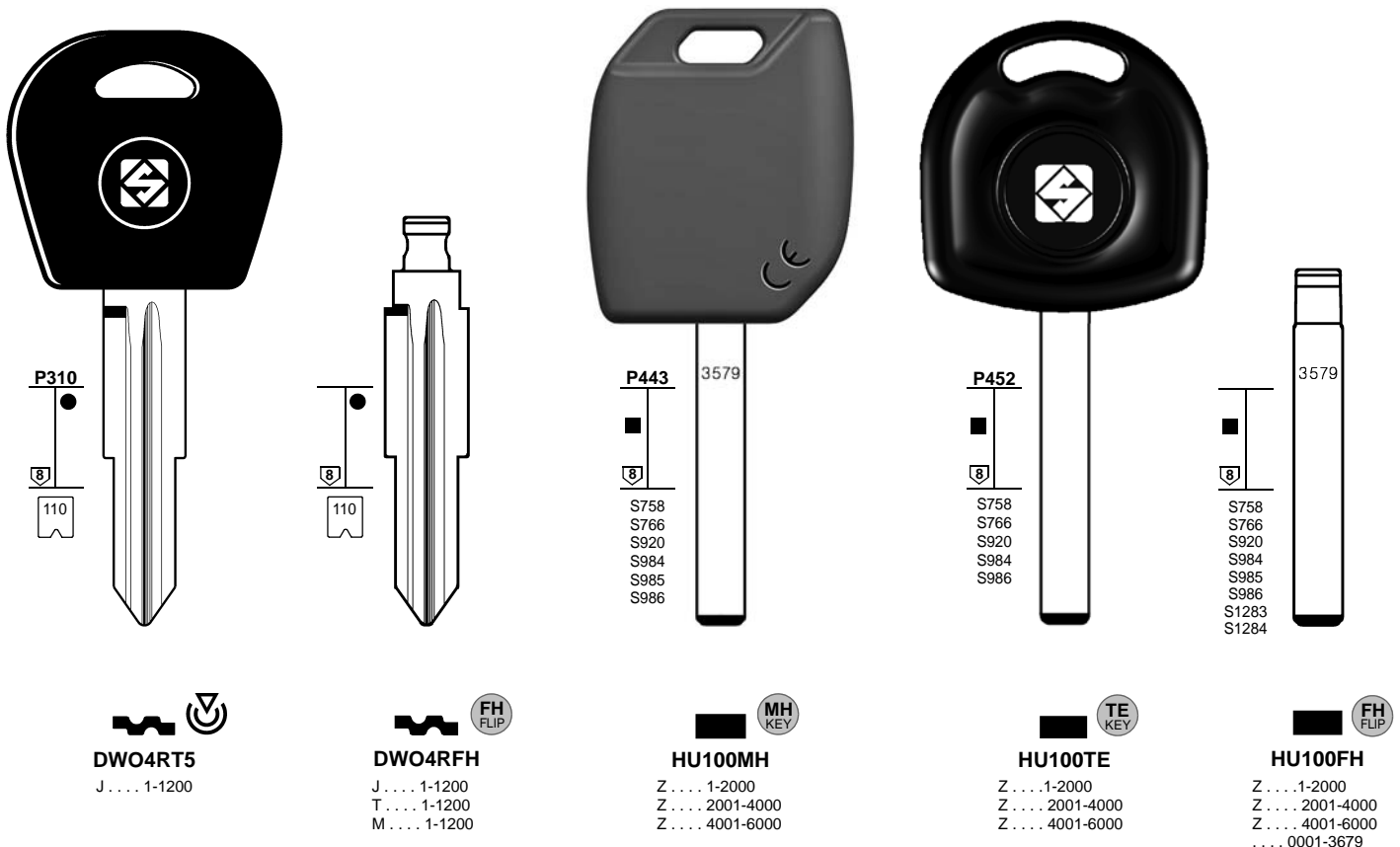

HUF - VALEO

HUF - VALEO



FOR:  
PER:

# CHEVROLET USA

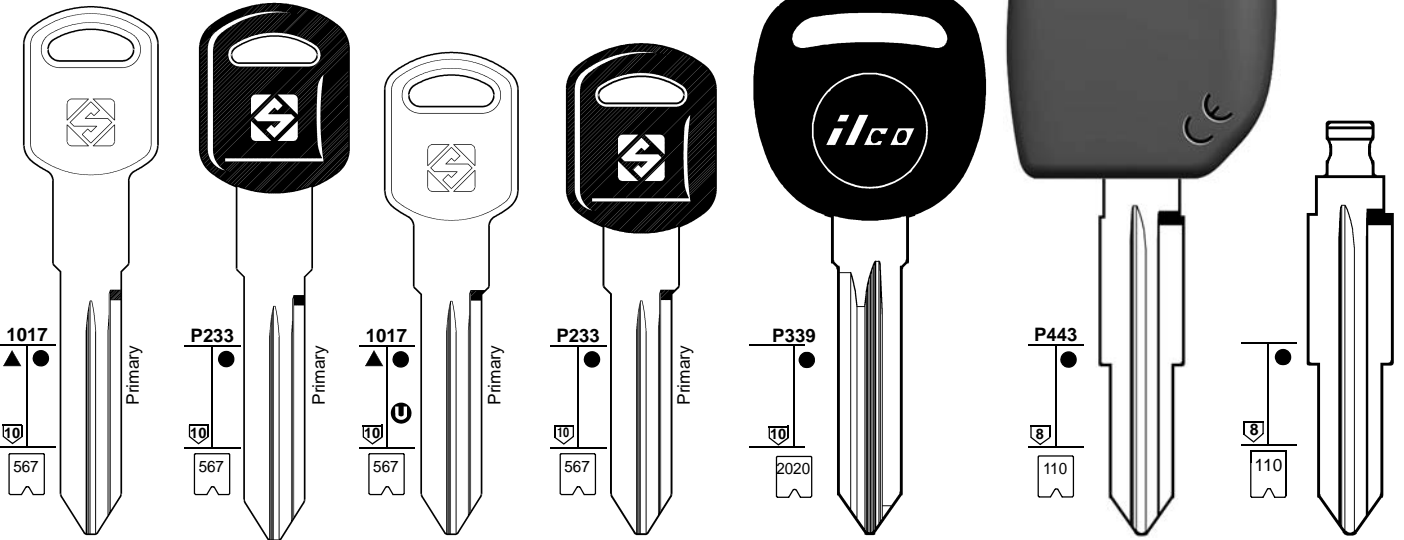

**GM39**  
..... AA00-7T51  
..... S000A-S711K

**GM39EP**  
..... AA00-7T51  
..... S000A-S711K

**GM40**  
..... AA00-7T51  
..... S000A-S711K

**GM40EP**  
..... AA00-7T51  
..... S000A-S711K

**B111-PT**  
G ..... 0-3631

**DW05MH**  
T ..... 1-1200

**DW05FH**  
T ..... 1-1200  
L ..... 1-1200  
V ..... 1-1200  
W ..... 2001-3200

BRIGGS & STRATTON

BRIGGS & STRATTON

FOR:  
PER:

# CHEVROLET USA

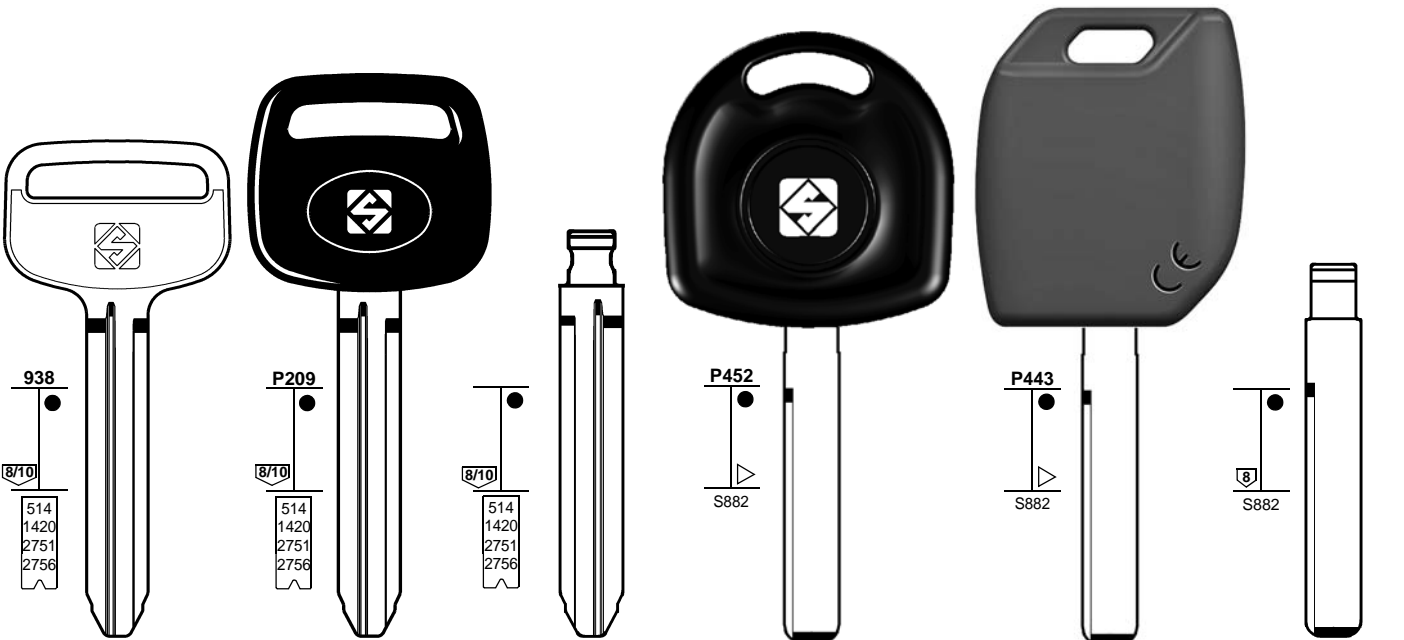

**TOY43R**  
.....  
10001-15000  
50000-59999  
60000-69999  
70000-75928

**TOY43RP**  
.....  
10001-15000  
50000-59999  
60000-69999  
70000-75928

**TOY43RFH**  
..... 1001-15000  
..... 70000-75928

**GM45TE**  
60000-62113

**GM45MH**  
60000-62113

**GM45FH**  
60000-62113

BRIGGS & STRATTON

BRIGGS & STRATTON





FOR:  
PER:

# CHEVROLET USA

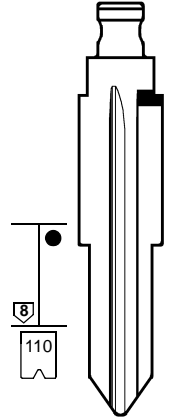
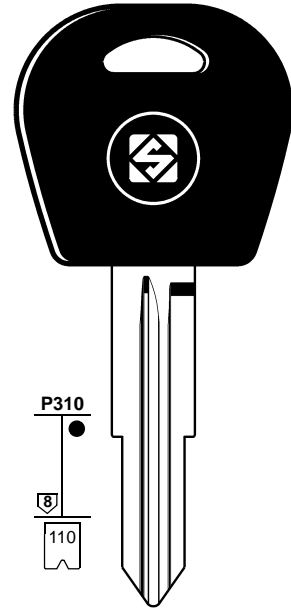
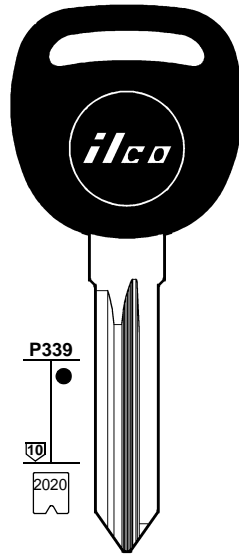
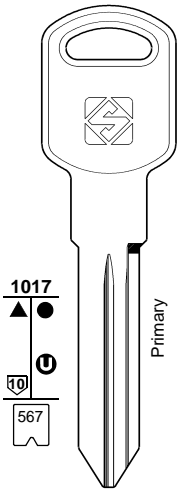
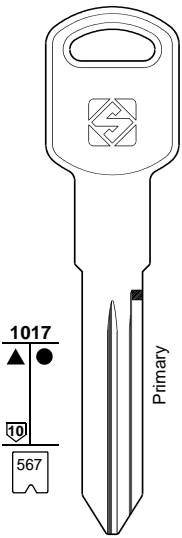

**GM39**

..... AA00-7T51  
..... S000A-S711K



**GM40**

..... AA00-7T51  
..... S000A-S711K



**B111-PT**

G ..... 0-3631



**DW05T5**

V ..... 1-1200



**DW05FH**

T ..... 1-1200  
L ..... 1-1200  
V ..... 1-1200  
V ..... 2001-3200

BRIGGS & STRATTON

FOR:  
PER:

# CHEVROLET USA

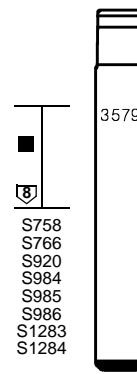
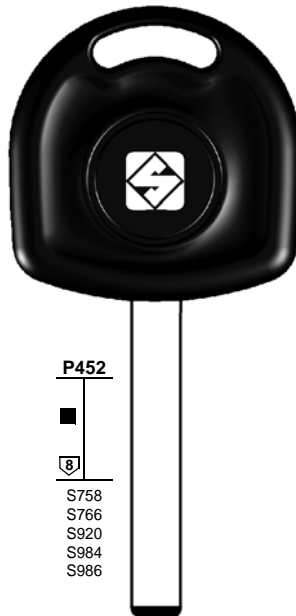
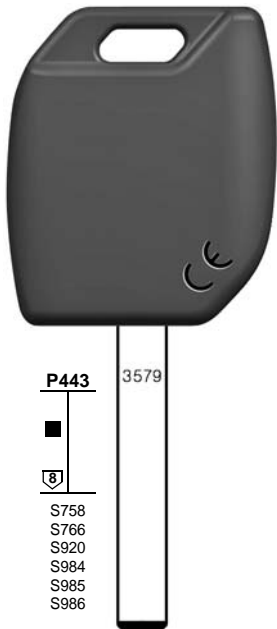

**P443**

3579



S758  
S766  
S920  
S984  
S985  
S986

**P452**



S758  
S766  
S920  
S984  
S986

3579



S758  
S766  
S920  
S984  
S985  
S986  
S1283  
S1284



**HU100MH**

Z ..... 1-2000  
Z ..... 2001-4000  
Z ..... 4001-6000



**HU100TE**

Z ..... 1-2000  
Z ..... 2001-4000  
Z ..... 4001-6000



**HU100FH**

Z ..... 1-2000  
Z ..... 2001-4000  
Z ..... 4001-6000  
..... 0001-3679

HUF - VALEO

HUF - VALEO



FOR:  
PER:

# CHEVROLET USA

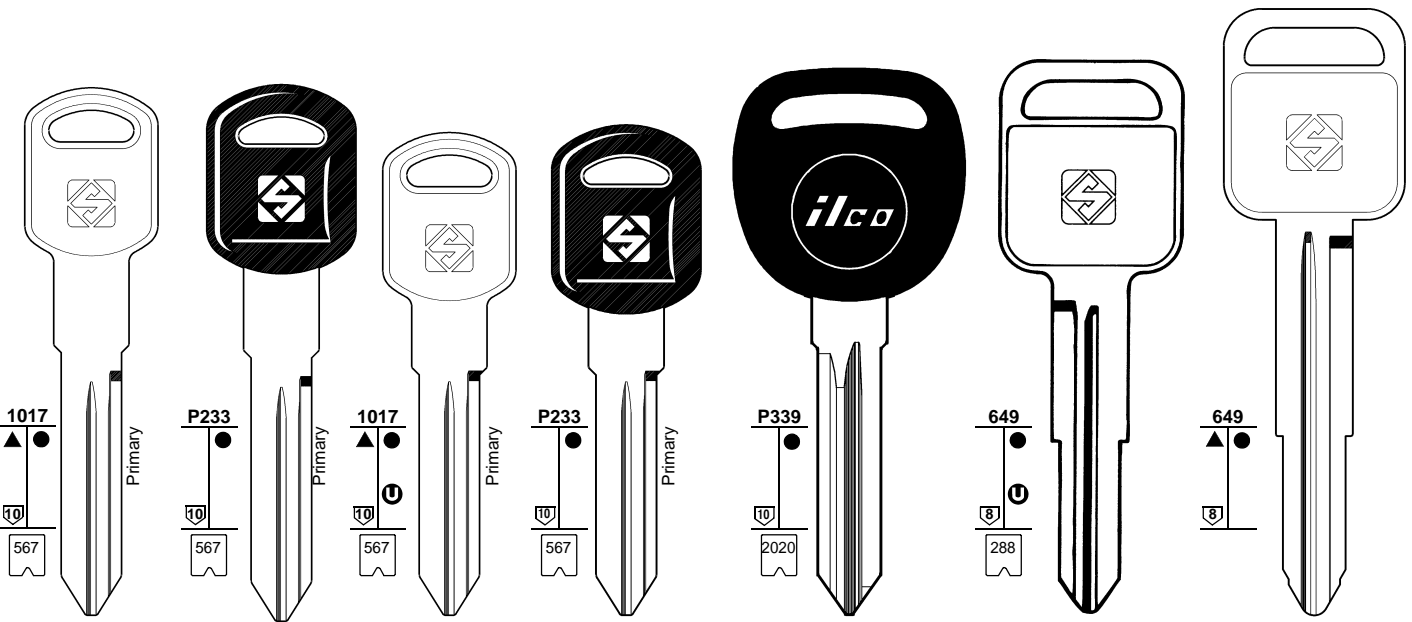

**GM39**  
..... AA00-7T51  
..... S000A-S711K



**GM39EP**  
..... AA00-7T51  
..... S000A-S711K



**GM40**  
..... AA00-7T51  
..... S000A-S711K



**GM40EP**  
..... AA00-7T51  
..... S000A-S711K



**B111-PT**  
G ..... 0-3631



**GM18R**  
..... 18100-19299  
..... 19300-19617



**GM19**

BRIGGS & STRATTON

BRIGGS & STRATTON

BRIGGS & STRATTON

FOR:  
PER:

# CHEVROLET USA

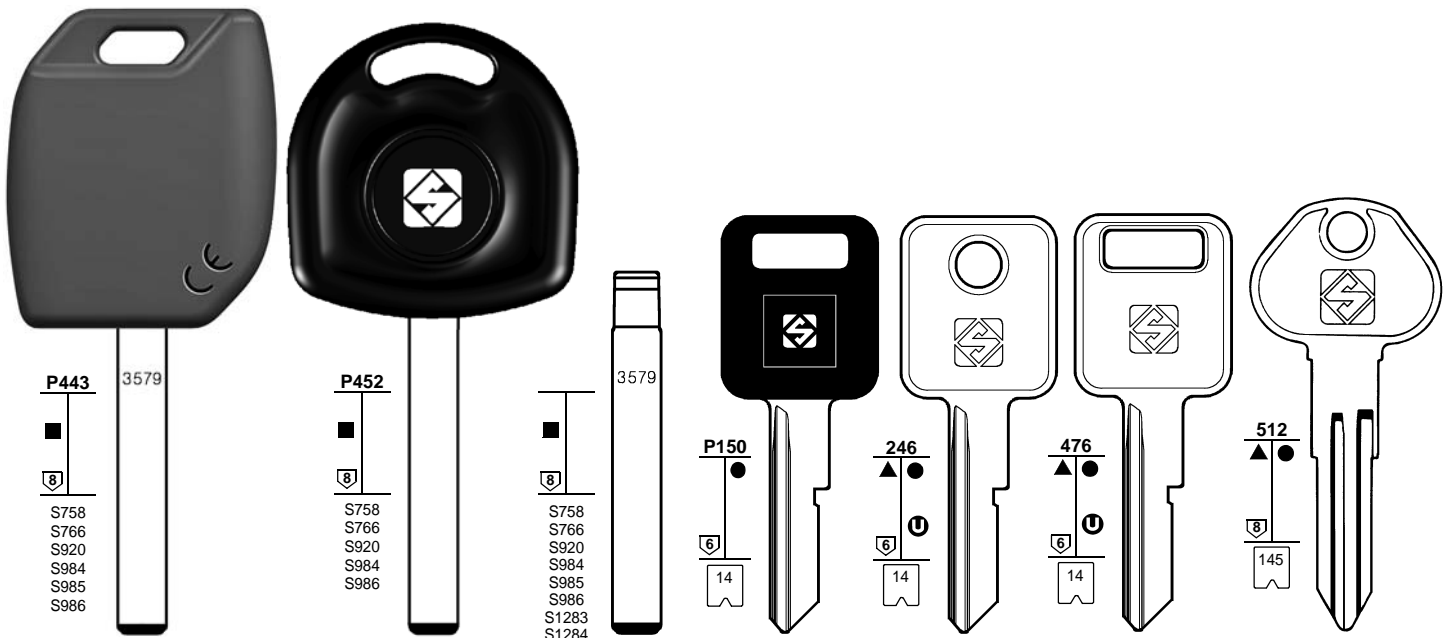

**HU100MH**  
Z ..... 1-2000  
Z ..... 2001-4000  
Z ..... 4001-6000



**HU100TE**  
Z ..... 1-2000  
Z ..... 2001-4000  
Z ..... 4001-6000



**HU100FH**  
Z ..... 1-2000  
Z ..... 2001-4000  
Z ..... 4001-6000  
..... 0001-3679



**GM5CP**  
E  
J ... 0.00-9.99  
J ... 0.00-99.9  
K ... 0.00-9.99  
K ... 0.00-99.9  
N ... 000-999  
P ... 000-999



**GM5**  
E  
J ... 0.00-9.99  
J ... 0.00-99.9  
K ... 0.00-9.99  
K ... 0.00-99.9  
N ... 000-999  
P ... 000-999



**GM5-OR**  
E  
J ... 0.00-9.99  
J ... 0.00-99.9  
K ... 0.00-9.99  
K ... 0.00-99.9  
N ... 000-999  
P ... 000-999



**DAT12R**  
S ..... 8001-9000

HUF - VALEO

HUF - VALEO

H ..L.00.0-99.9

H ..L.00.0-99.9

H ..L.00.0-99.9



FOR:  
PER:

# CHEVROLET USA

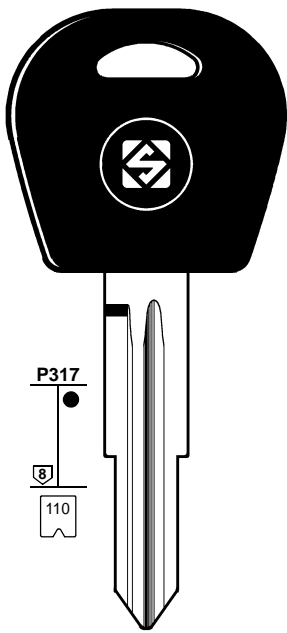

P317  
8  
110

**DWO4RAP**  
J ..... 1-1200  
M ..... 1-1200

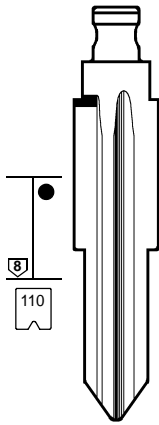

8  
110

**DWO4RFH** **FH FLIP**  
J ..... 1-1200  
T ..... 1-1200  
M ..... 1-1200

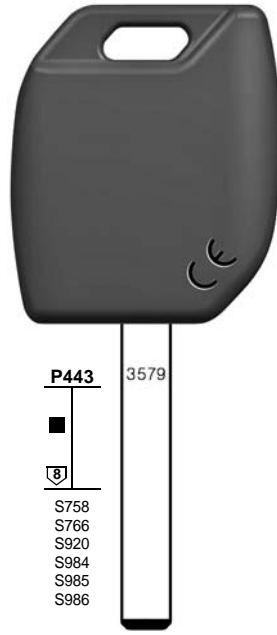

P443 3579  
8  
S758  
S766  
S920  
S984  
S985  
S986

**HU100MH** **MH KEY**  
Z ..... 1-2000  
Z ..... 2001-4000  
Z ..... 4001-6000

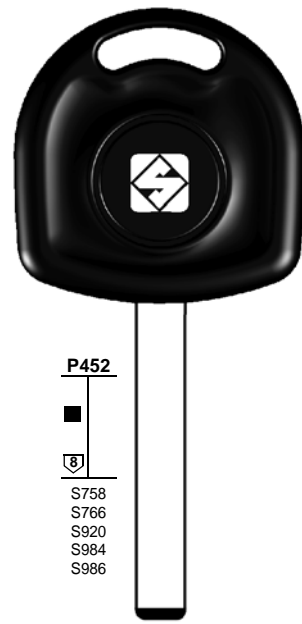

P452  
8  
S758  
S766  
S920  
S984  
S986

**HU100TE** **TE KEY**  
Z ..... 1-2000  
Z ..... 2001-4000  
Z ..... 4001-6000



3579  
8  
S758  
S766  
S920  
S984  
S985  
S986  
S1283  
S1284

**HU100FH** **FH FLIP**  
Z ..... 1-2000  
Z ..... 2001-4000  
Z ..... 4001-6000  
..... 0001-3679

HUF - VALEO

HUF - VALEO

FOR:  
PER:

# CHEVROLET USA

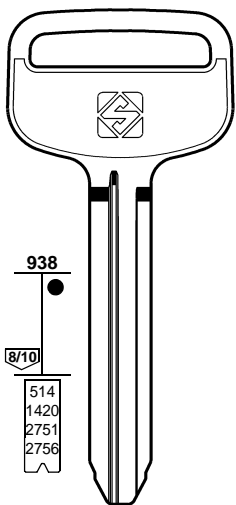

938  
8/10  
514  
1420  
2751  
2756

**TOY43R**  
.....  
10001-15000  
50000-59999  
60000-69999  
70000-75928

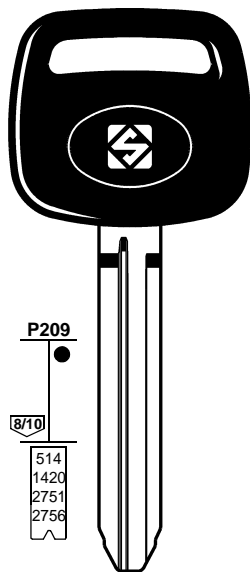

P209  
8/10  
514  
1420  
2751  
2756

**TOY43RP**  
.....  
10001-15000  
50000-59999  
60000-69999  
70000-75928

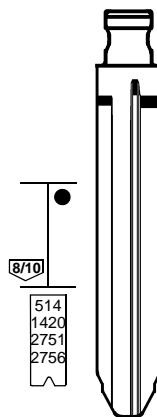

8/10  
514  
1420  
2751  
2756

**TOY43RFH** **FH FLIP**  
..... 1001-15000  
..... 70000-75928

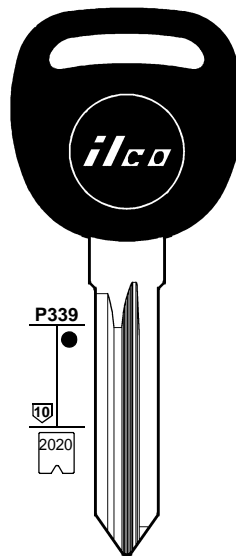

P339  
10  
2020

**B111-PT**  
G ..... 0-3631

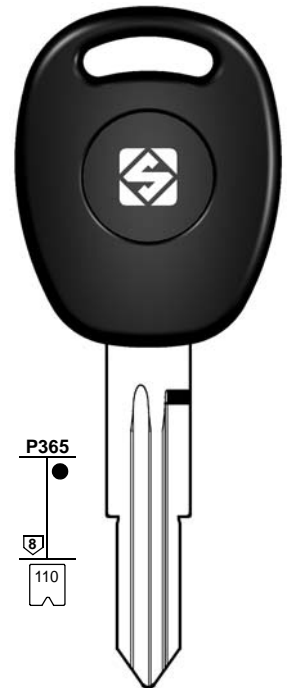

P365  
8  
110

**DWO4CT6**  
J ..... 1-1200  
M ..... 1-1200





FOR:  
PER:

# CHEVROLET USA

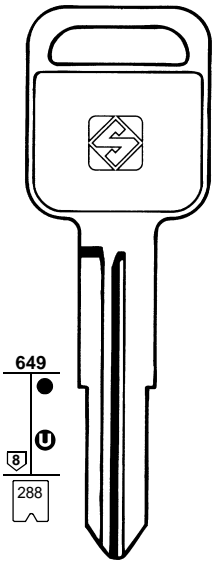

649  
U  
288



**GM18R**

..... 18100-19299  
..... 19300-19617

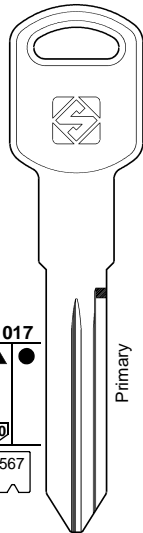

1017  
10  
567



**GM39**

..... AA00-7T51  
..... S000A-S711K

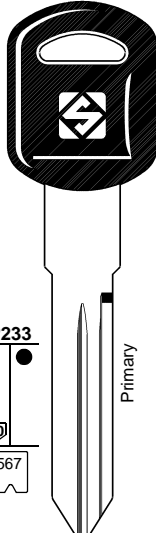

P233  
10  
567



**GM39EP**

..... AA00-7T51  
..... S000A-S711K

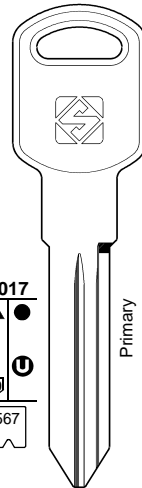

1017  
10  
567



**GM40**

..... AA00-7T51  
..... S000A-S711K

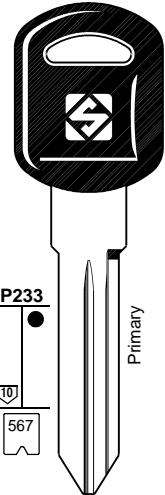

P233  
10  
567



**GM40EP**

..... AA00-7T51  
..... S000A-S711K

BRIGGS & STRATTON

BRIGGS & STRATTON

BRIGGS & STRATTON

FOR:  
PER:

# CHEVROLET USA

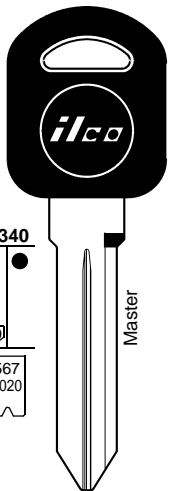

P340  
10  
567  
2020



**B97-PT**

..... 1-1988  
H..... 1-3988  
O..... 5000-6999  
..... S000A-S711K

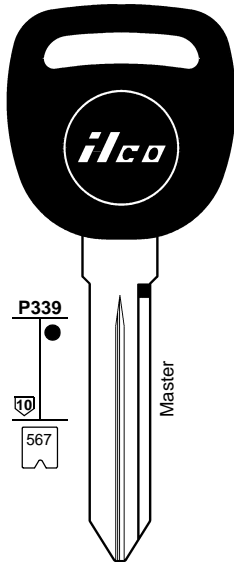

P339  
10  
567



**B99-PT**

..... 1-1988  
H..... 1-3988  
O..... 5000-6999  
..... S000A-S711K

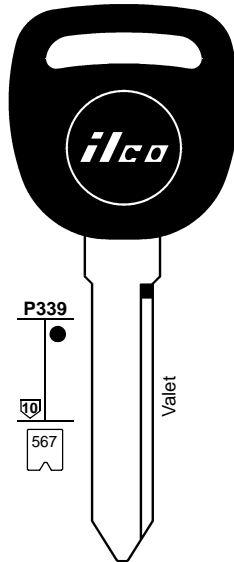

P339  
10  
567



**B100-PT**

..... 1-1988  
H..... 1-3988  
O..... 5000-6999  
..... S000A-S711K

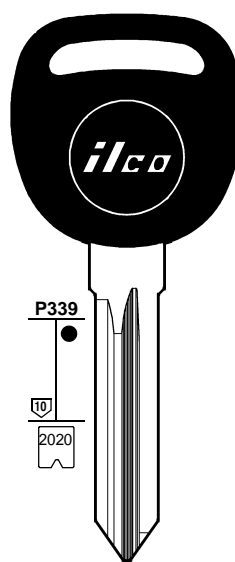

P339  
10  
2020



**B111-PT**

G..... 0-3631

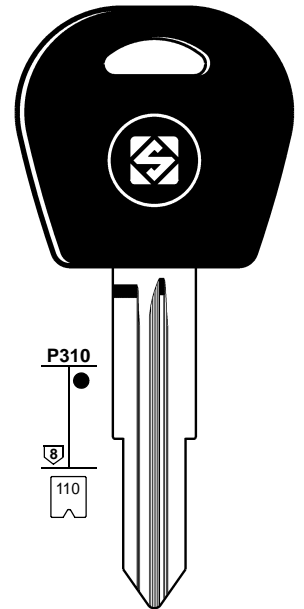

P310  
110



**DW05RT5**

T..... 1-1200

BRIGGS & STRATTON

BRIGGS & STRATTON



FOR:  
PER:

# CHEVROLET USA



P443



S758  
S766  
S920  
S984  
S985  
S986

3579



**HU100MH**

Z . . . . 1-2000  
Z . . . . 2001-4000  
Z . . . . 4001-6000



P452



S758  
S766  
S920  
S984  
S986

3579



**HU100TE**

Z . . . . 1-2000  
Z . . . . 2001-4000  
Z . . . . 4001-6000

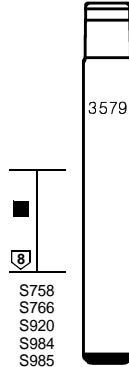

3579



S758  
S766  
S920  
S984  
S985  
S986  
S1283  
S1284



**HU100FH**

Z . . . . 1-2000  
Z . . . . 2001-4000  
Z . . . . 4001-6000  
. . . . . 0001-3679

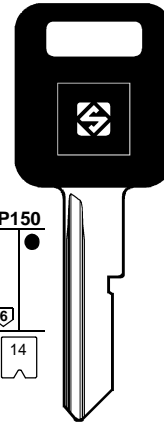

P150



14



**GM5CP**

E  
. J . . 0.00-9.99  
. J . . 00.0-99.9  
. K . . 0.00-9.99  
. K . . 00.0-99.9  
N . . . 000-999  
P . . . 000-999  
H . . L.00.0-99.9

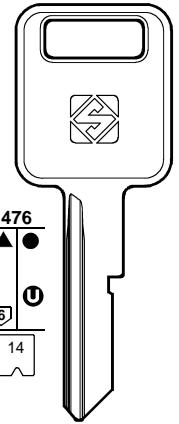

476



14



**GM5-OR**

E  
. J . . 0.00-9.99  
. J . . 00.0-99.9  
. K . . 0.00-9.99  
. K . . 00.0-99.9  
N . . . 000-999  
P . . . 000-999  
H . . L.00.0-99.9

HUF - VALEO

HUF - VALEO

FOR:  
PER:

# CHEVROLET-DAEWOO

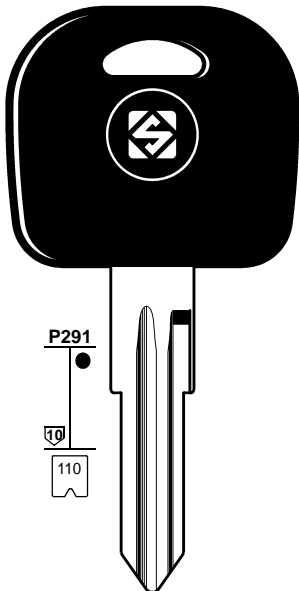

P291



110



**HU46AT5**

S . . . . 5298-6300

HUF

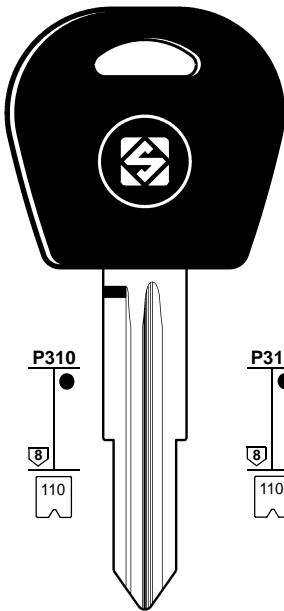

P310



110



**DWO4RT6**

J . . . . 1-1200

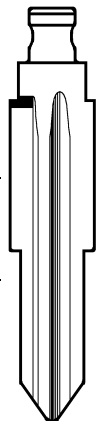

P310



110



**DWO4RFH**

J . . . . 1-1200  
T . . . . 1-1200  
M . . . . 1-1200

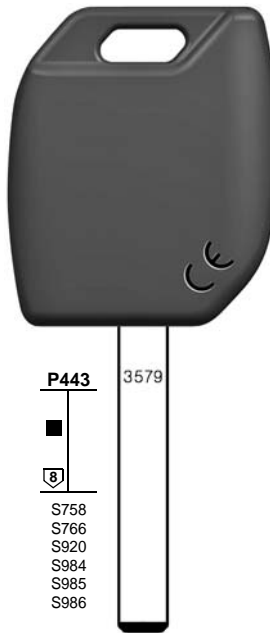

P443



S758  
S766  
S920  
S984  
S985  
S986

3579



**HU100MH**

Z . . . . 1-2000  
Z . . . . 2001-4000  
Z . . . . 4001-6000

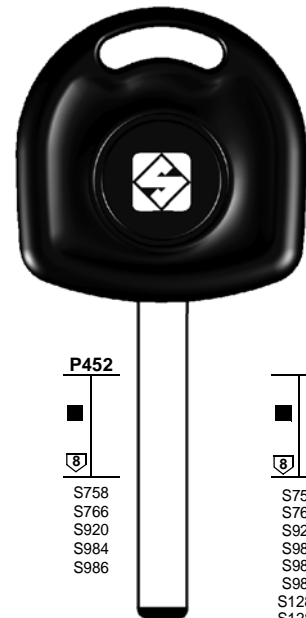

P452



S758  
S766  
S920  
S984  
S986



**HU100TE**

Z . . . . 1-2000  
Z . . . . 2001-4000  
Z . . . . 4001-6000



3579



S758  
S766  
S920  
S984  
S985  
S986  
S1283  
S1284



**HU100FH**

Z . . . . 1-2000  
Z . . . . 2001-4000  
Z . . . . 4001-6000  
. . . . . 0001-3679

HUF - VALEO

HUF - VALEO



FOR:  
PER:

## CHEVROLET-DAEWOO

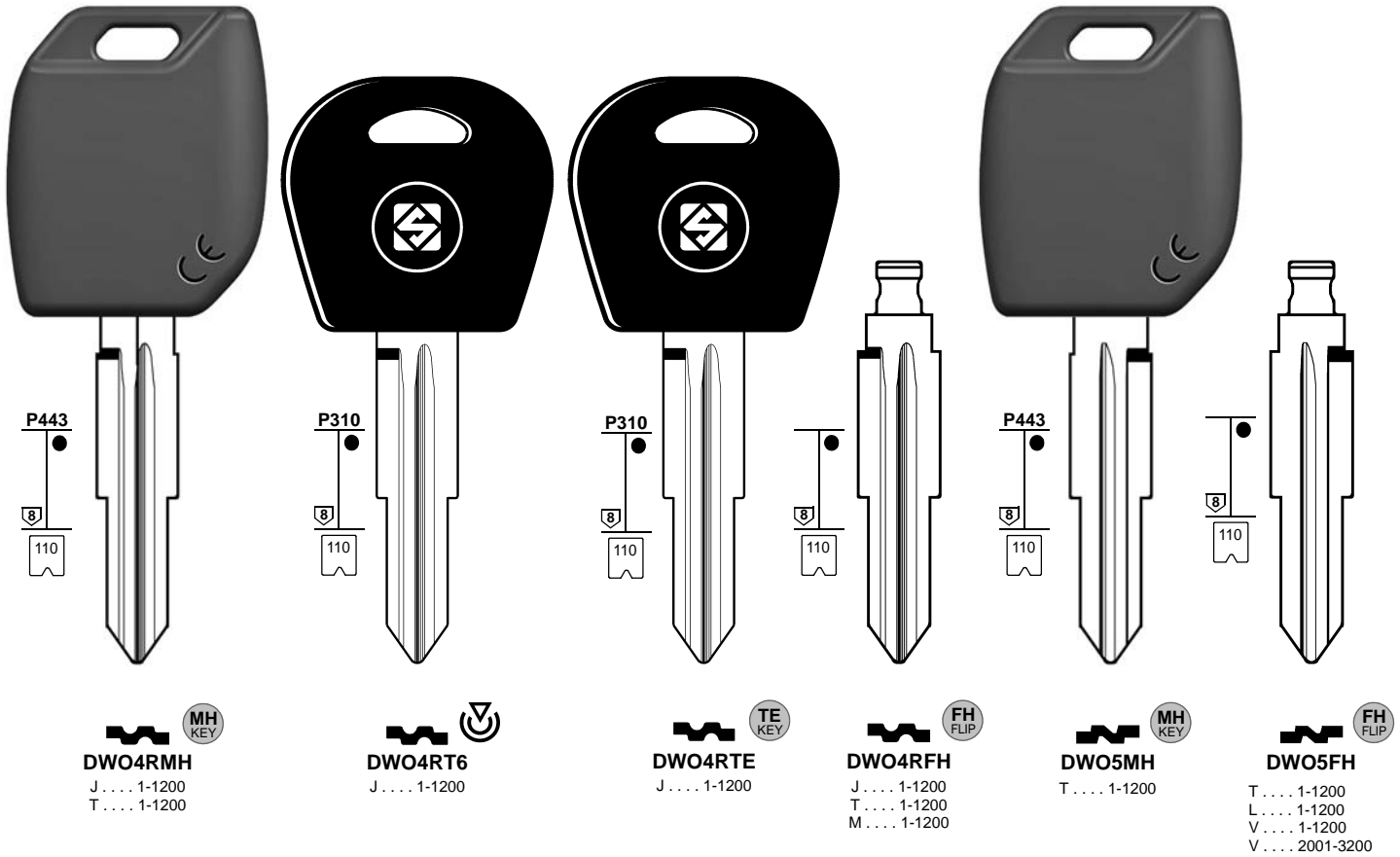

FOR:  
PER:

## CHEVROLET-DAEWOO

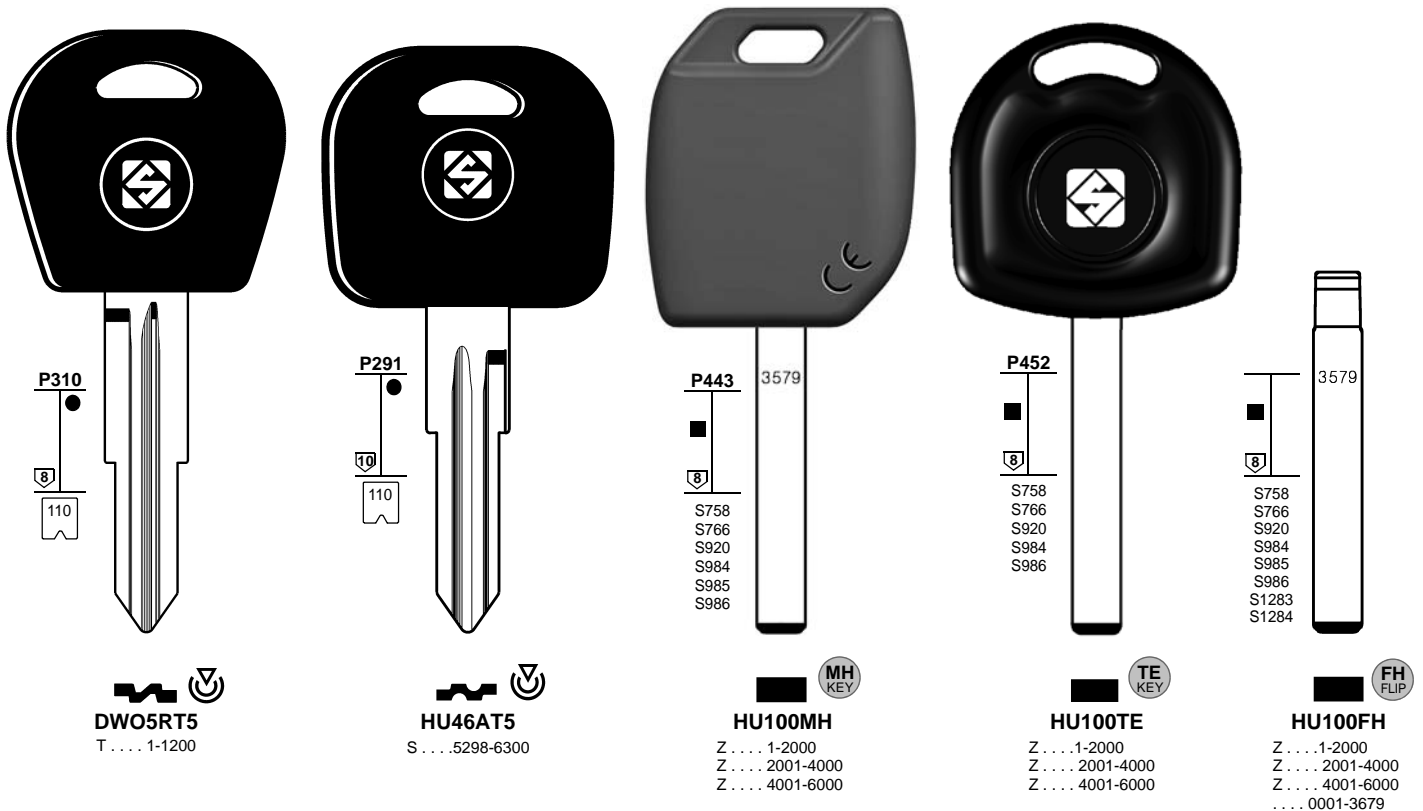

HUF - VALEO

HUF - VALEO





FOR:  
PER:

# CHEVROLET-DAEWOO

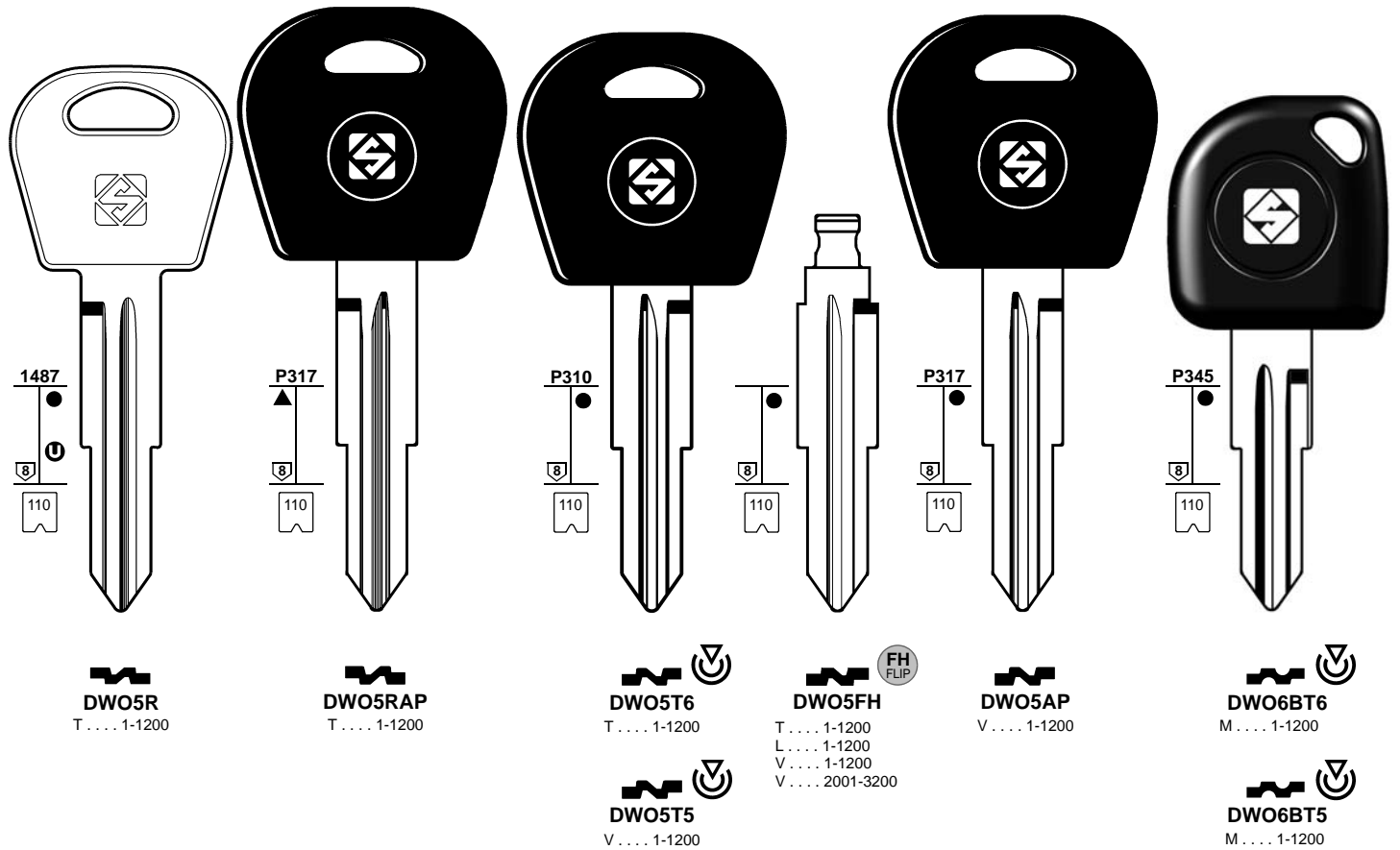

FOR:  
PER:

# CHEVROLET-DAEWOO

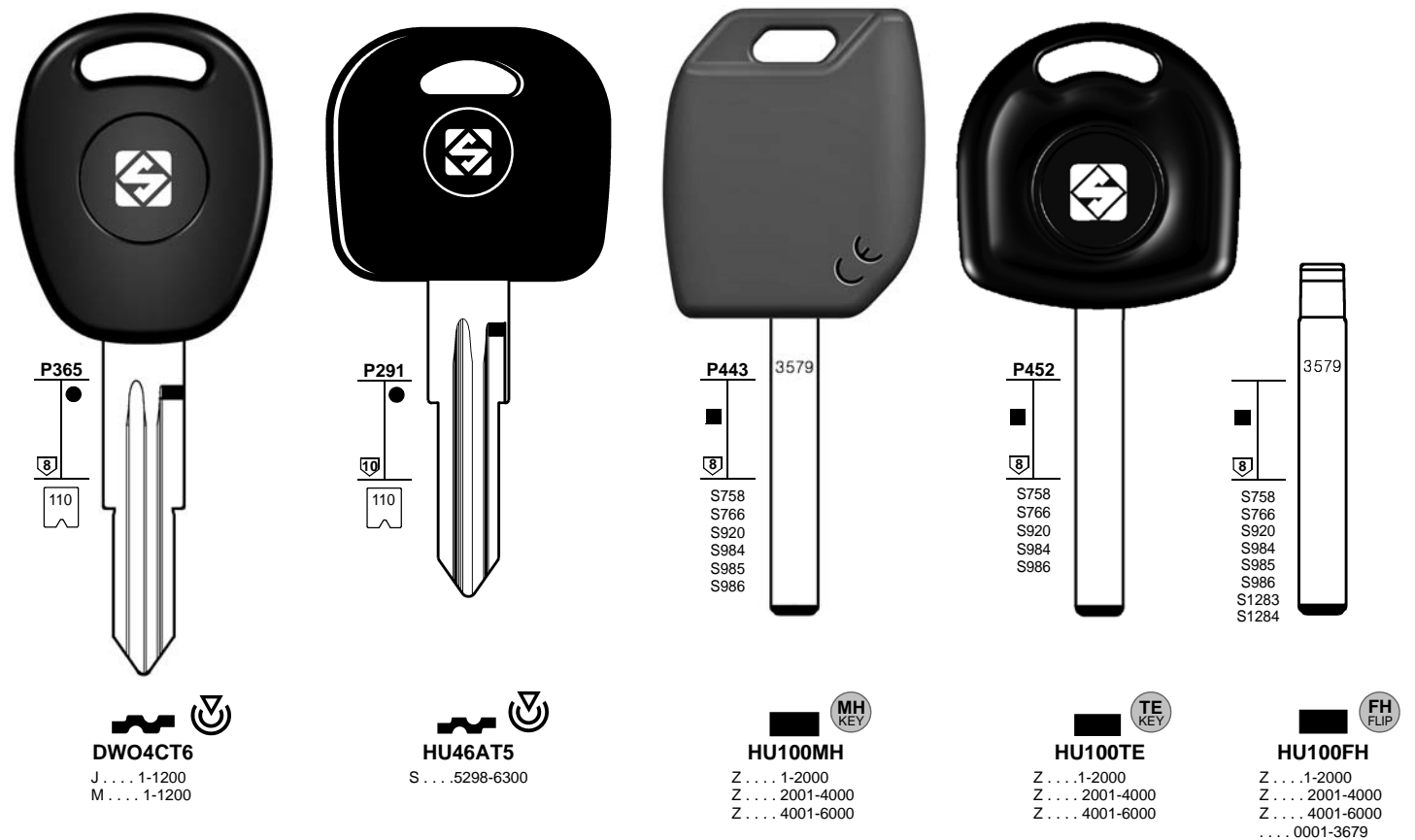

VALEO

VALEO



FOR:  
PER:

# CHEVROLET-DAEWOO

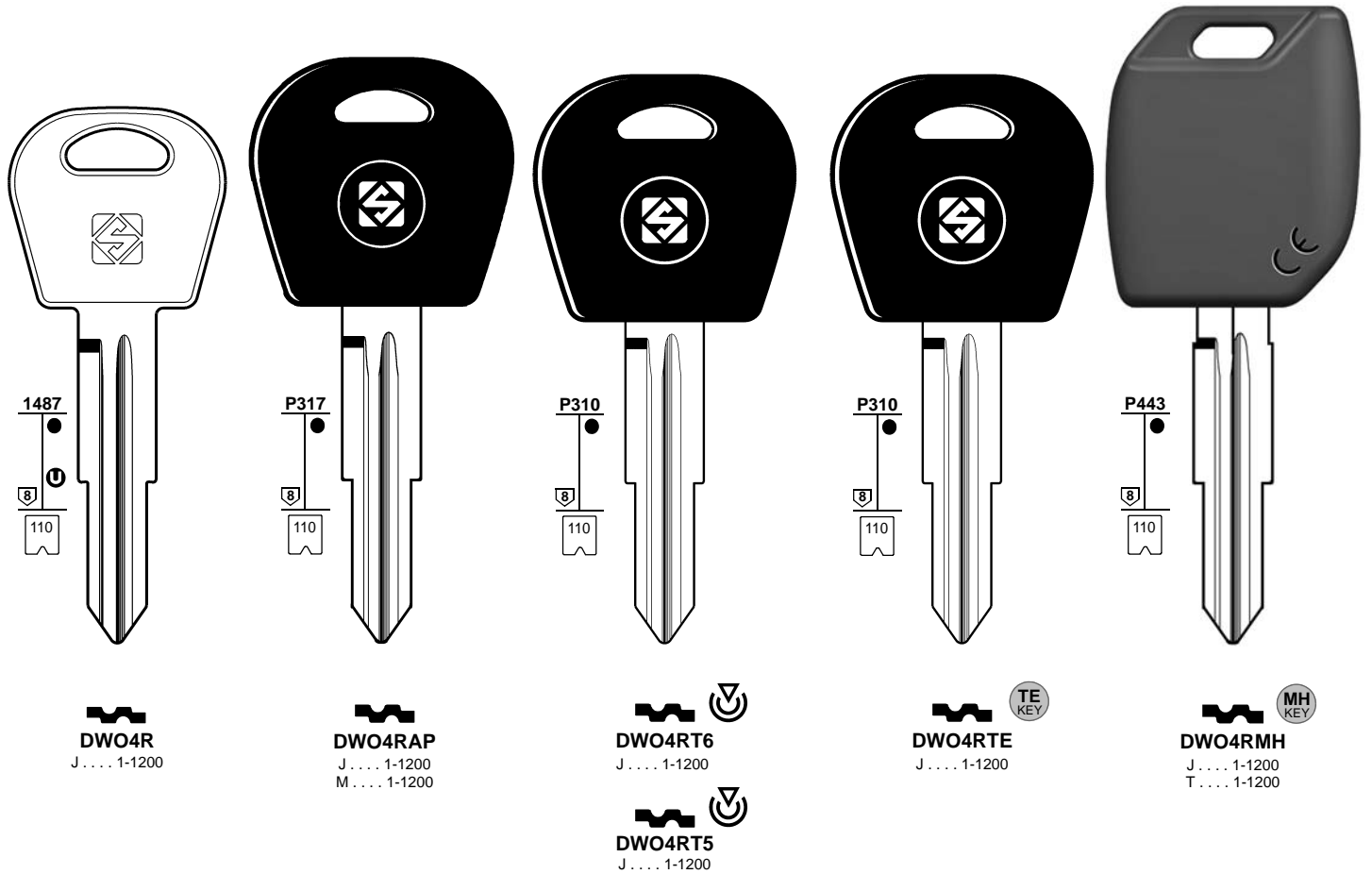

FOR:  
PER:

# CHEVROLET-DAEWOO

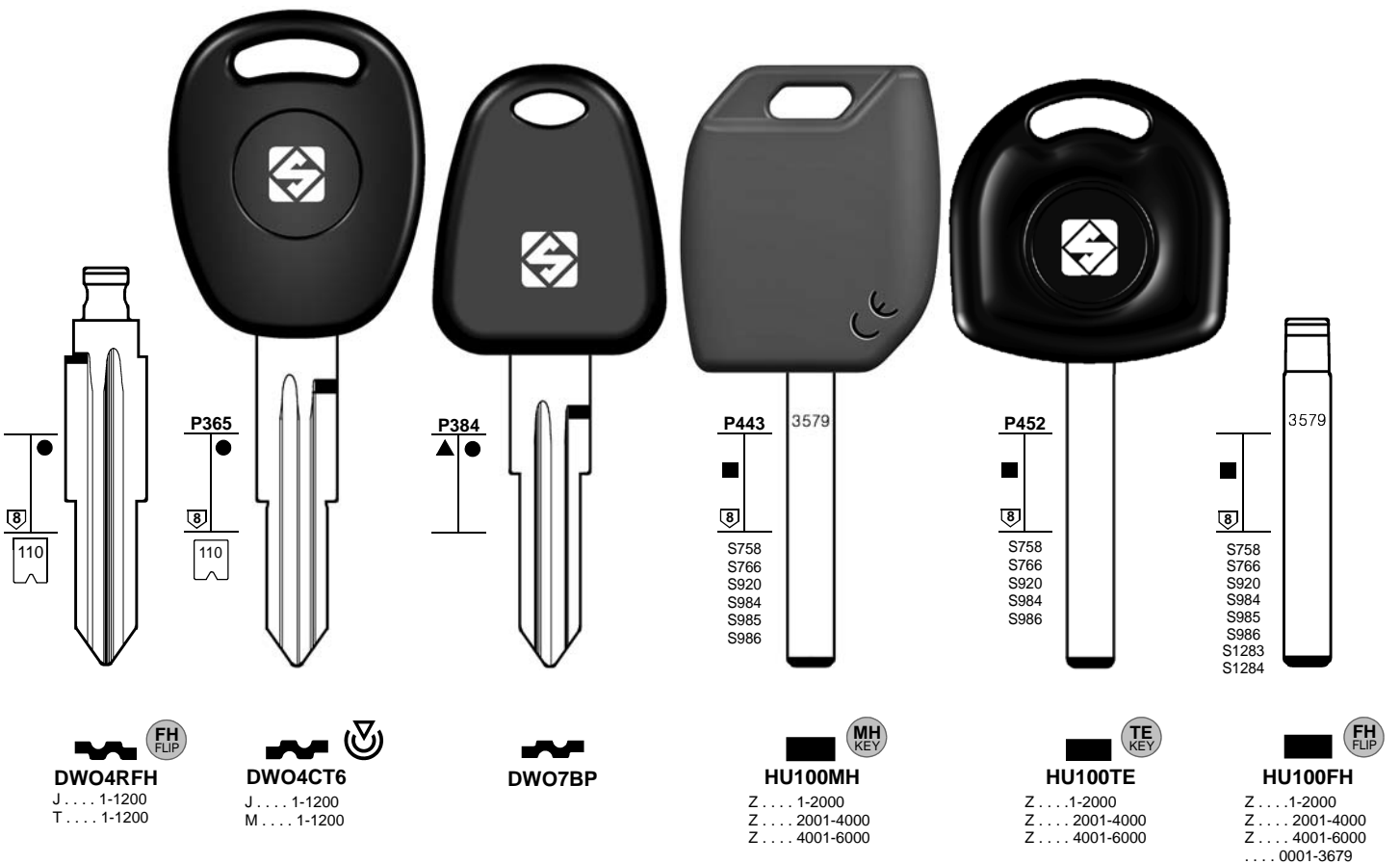

HUF - VALEO

HUF - VALEO



FOR:  
PER:

# CHRYSLER

**P135**  
▲ ●  
7  
537  
745

**1128**  
●  
7/8  
537  
745

**P270**  
●  
7/8  
537  
745

**P462**  
●  
7/8  
537  
745

**P443**  
●  
7/8  
537  
745

**P443**  
●  
7/8  
537  
745

**CY22P**  
M . . . . 1-2618  
FL . . . . 1-262  
L . . . . 1-3580

**CY24**  
L . . . . 1-3580  
M . . . . 1-2618

**CY24BP**  
L . . . . 1-3580  
M . . . . 1-2618

**CY24TE** **TE KEY**  
L . . . . 1-3580  
M . . . . 1-2618

**CY24MH** **MH KEY**  
L . . . . 1-3580  
M . . . . 1-2618

**CY24FH** **FH FLIP**  
L . . . . 1-3580  
M . . . . 1-2618  
FT . . . . 1001-3000

FOR:  
PER:

# CHRYSLER

**P337**  
●  
7/8  
537  
745

**P337**  
●  
8  
754

**P337**  
●  
7/8  
537  
745

**P442**  
●  
7/8  
537  
745

**Y160-PT**  
L . . . . 1-3580  
M . . . . 1-2618

**Y162-PT**  
M . . . . 1-2618

**Y164-PT**  
L . . . . 1-3580  
M . . . . 1-2618

**EK3P-Y170**  
L . . . . 1-3580  
M . . . . 1-2618

1	2	2a	3	3a	3b	e1+e2		6	42+71	72	43+44a	12	15
						GTI COMPATIBLE		IGNITION					
CAR MAKE MODEL	FROM	TO	SILCA REF.	SILCA REF.	SILCA REF.	COPY	GEN.	TRANSP. TYPE	FAST COPY PLUS RW4 PLUS FAST COPY/RW4	FAST COPY PLUS RW4 PLUS	FAST COPY RW4	STP	
For more info on the uses of car keys, refer to the Silca Electronic Keys Catalogue:													
<b>CHRYSLER</b>													
200	2011		Y164-PT					PH / CR2	46				
200	2011		CY24MH	CY24TE	CY24FH	Y	Y	PH / CR2	46	Y	P-BOX		
300	1998	2004	CY24MH	CY24TE	CY24FH	Y	Y	TEX / CR	64	Y	P-BOX		
300	1999	2004	Y160-PT					TEX / CR	64				F
300	2005	2008	Y164-PT					PH / CR2	46				F
300	2005	2008	CY24MH	CY24TE	CY24FH	Y	Y	PH / CR2	46	Y	P-BOX		
300	2008	2011						PH / CR2	46				
300	2008		EK3P-Y170					PH / CR2	46	Y	P-BOX		
300	2012		SMARTKEY					PH / CR2	46				
ASPEN	2007	2009	Y164-PT					PH / CR2	46				F
ASPEN	2007	2009	CY24MH	CY24TE	CY24FH	Y	Y	PH / CR2	46	Y	P-BOX		
CIRRUS	1999	2000	Y160-PT					TEX / CR	64				F
CIRRUS	1999	2000	CY24MH	CY24TE	CY24FH	Y	Y	TEX / CR	64	Y	P-BOX		
CIRRUS Convertible	2001	2002	Y160-PT					TEX / CR	64				F
CIRRUS Convertible	2001	2002	CY24MH	CY24TE	CY24FH	Y	Y	TEX / CR	64	Y	P-BOX		
CIRRUS SEDAN	2001	2002	Y160-PT					TEX / CR	64				F
CIRRUS SEDAN	2001	2002	CY24MH	CY24TE	CY24FH	Y	Y	TEX / CR	64	Y	P-BOX		
CONCORDE	1998	2004	Y160-PT					TEX / CR	64				F
CONCORDE	1998	2004	CY24MH	CY24TE	CY24FH	Y	Y	TEX / CR	64	Y	P-BOX		
CROSSFIRE	2003	2007						PH	33				
GRAND VOYAGER	1996	1997	CY24BP										
GRAND VOYAGER	1996	1997	CY24										
LHS	1999	2001	Y160-PT					TEX / CR	64				F
LHS	1999	2001	CY24MH	CY24TE	CY24FH	Y	Y	TEX / CR	64	Y	P-BOX		
NEON	2000	2005	Y160-PT					TEX / CR	64				F
NEON	2000	2005	CY24MH	CY24TE	CY24FH	Y	Y	TEX / CR	64	Y	P-BOX		
NEW YORKER	1998	2001	CY24MH	CY24TE	CY24FH	Y	Y	TEX / CR	64	Y	P-BOX		
NEW YORKER	1999	2004	Y160-PT					TEX / CR	64				F
PACIFICA	2004	2008	Y164-PT					PH / CR2	46				
PACIFICA	2004	2008	CY24MH	CY24TE	CY24FH	Y	Y	PH / CR2	46	Y	P-BOX		
PROWLER	2001	2002	CY22P										
PT CRUISER	2001	2005	Y160-PT					TEX / CR	64				F
PT CRUISER	2001	2005	CY24MH	CY24TE	CY24FH	Y	Y	TEX / CR	64	Y	P-BOX		
PT CRUISER	2006	2011	Y164-PT					PH / CR2	46				
PT CRUISER	2006	2011	CY24MH	CY24TE	CY24FH	Y	Y	PH / CR2	46	Y	P-BOX		
PT CRUISER LE	2001	2005	Y160-PT					TEX / CR	64				F
PT CRUISER LE	2001	2005	CY24MH	CY24TE	CY24FH	Y	Y	TEX / CR	64	Y	P-BOX		
SEBRING	2007	2011	Y164-PT					PH / CR2	46				
SEBRING	2007	2011	CY24MH	CY24TE	CY24FH	Y	Y	PH / CR2	46	Y	P-BOX		
SEBRING CONVERT	2001	2006	Y160-PT					TEX / CR	64				F
SEBRING CONVERT	2001	2006	CY24MH	CY24TE	CY24FH	Y	Y	TEX / CR	64	Y	P-BOX		
SEBRING CONVERT	2007	2011	Y164-PT					PH / CR2	46				
SEBRING CONVERT	2007	2011	CY24MH	CY24TE	CY24FH	Y	Y	PH / CR2	46	Y	P-BOX		
Sebring Coupè	2001	2005	Y162-PT					TEX / CR	60				
SEBRING SEDAN	1998	2006	Y160-PT					TEX / CR	64				F
SEBRING SEDAN	1999	2006	CY24MH	CY24TE	CY24FH	Y	Y	TEX / CR	64	Y	P-BOX		

FOR:  
PER:

# CHRYSLER

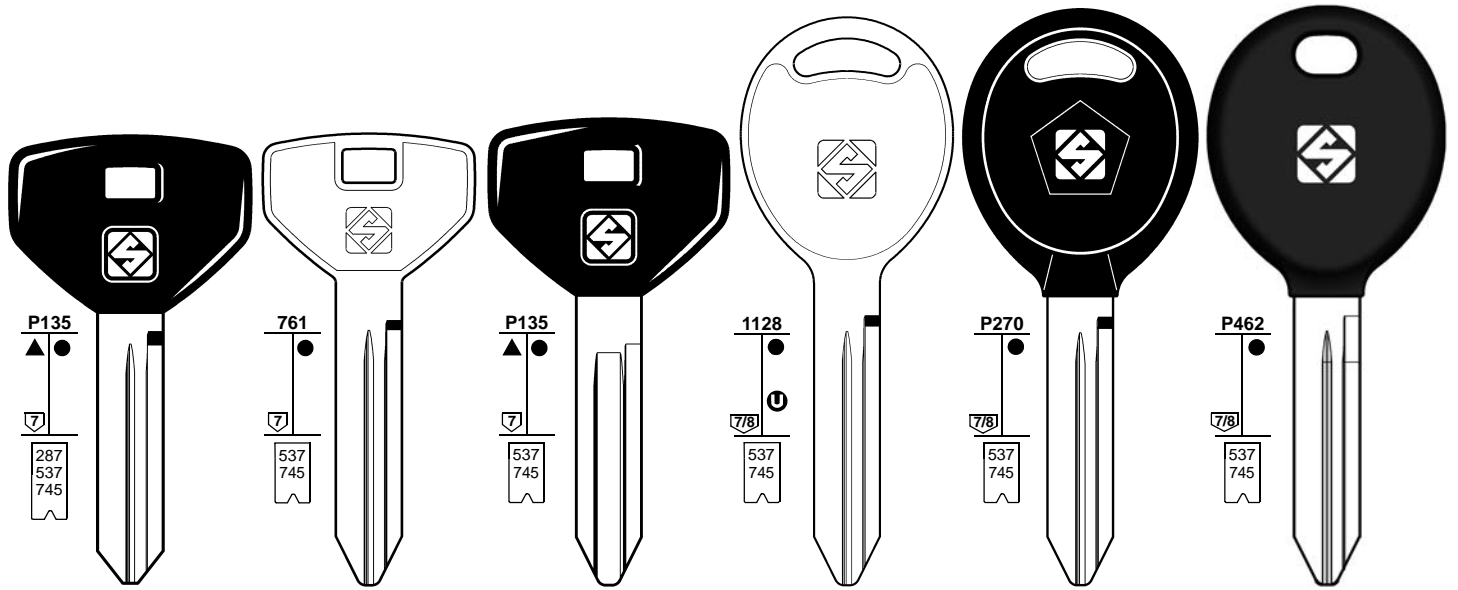

**CY19P**  
J . . . . 1-3580

**CY16P**  
F . . . . 0-1394  
G . . . . 0-1394  
M . . . . 1-2618  
L . . . . 1-3580

**CY23**  
M . . . . 1-2618  
L . . . . 1-3580

**CY22P**  
M . . . . 1-2618  
FL . . . 1-262  
L . . . . 1-3580

**CY24**  
L . . . . 1-3580  
M . . . . 1-2618

**CY24BP**  
L . . . . 1-3580  
M . . . . 1-2618

**CY24TE** TE KEY  
L . . . . 1-3580  
M . . . . 1-2618

FOR:  
PER:

# CHRYSLER



**CY24FH** FH FLIP  
L . . . . 1-3580  
M . . . . 1-2618  
FT . . . 1001-3000

**CY24MH** MH KEY  
L . . . . 1-3580  
M . . . . 1-2618

**Y160-PT**  
L . . . . 1-3580  
M . . . . 1-2618

**Y162-PT**  
M . . . . 1-2618

**Y164-PT**  
L . . . . 1-3580  
M . . . . 1-2618

**EK3P-Y170**  
L . . . . 1-3580  
M . . . . 1-2618







MITSUBISHI



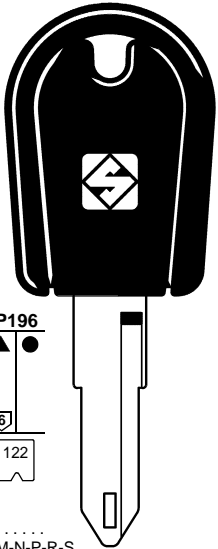
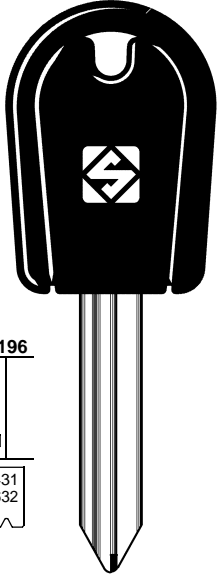
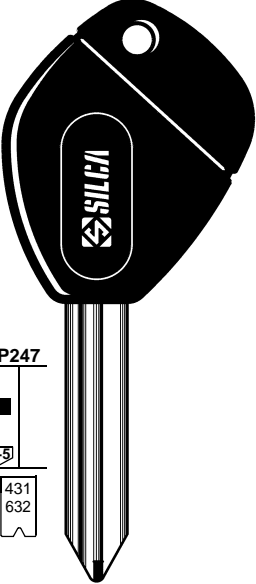
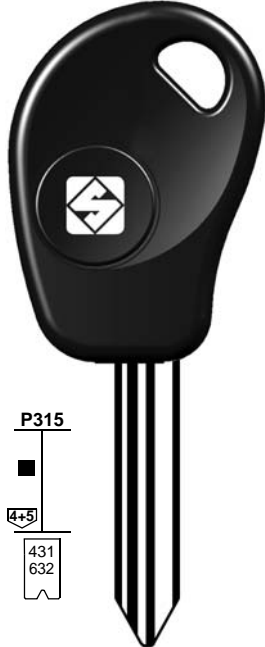
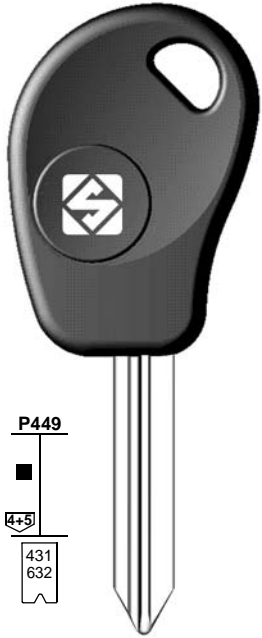

FOR:  
PER:

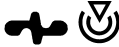



# CITROËN

 <p><b>P196</b></p> <p>▲ ●</p> <p>6</p> <p>122</p> <p>..... M-N-P-R-S</p>	 <p><b>P196</b></p> <p>■</p> <p>4+5</p> <p>431 632</p> <p>..... 0111111-628888 ..... H 0111111-628888</p> <p>63/99 ..... 1-2-4-6-8 63/99 ..... H 1-2-4-6-8</p>	 <p><b>P247</b></p> <p>■</p> <p>4+5</p> <p>431 632</p> <p>..... 0111111-628888 ..... H 0111111-628888</p> <p>63/99 ..... 1-2-4-6-8 63/99 ..... H 1-2-4-6-8</p>	 <p><b>P315</b></p> <p>■</p> <p>4+5</p> <p>431 632</p> <p>..... 0111111-628888 ..... H 0111111-628888</p> <p>63/99 ..... 1-2-4-6-8 63/99 ..... H 1-2-4-6-8</p>	 <p><b>P449</b></p> <p>■</p> <p>4+5</p> <p>431 632</p> <p>..... 0111111-628888 ..... H 0111111-628888</p> <p>63/99 ..... 1-2-4-6-8 63/99 ..... H 1-2-4-6-8</p>	
 <b>NE72LP</b>	 <b>SX9GP</b>	 <b>SX9CP</b>	 <b>SX9T5</b>	 <b>SX9T14</b>	 <b>SX9TE</b>

**SIMPLEX**

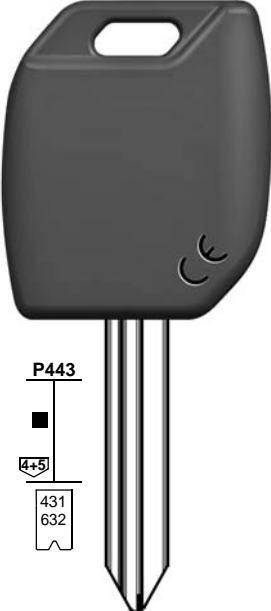
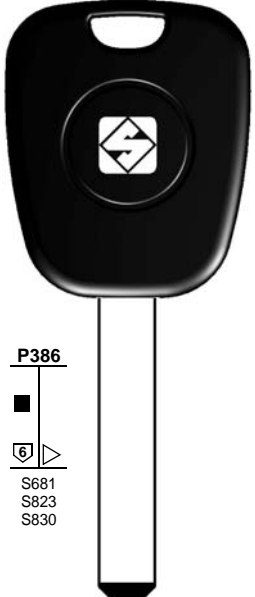
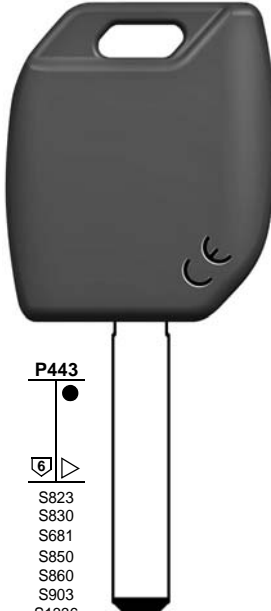
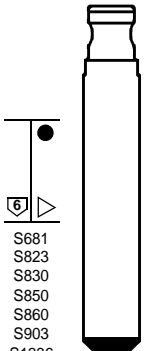
FOR:  
PER:

# CITROËN

 <p><b>P443</b></p> <p>■</p> <p>4+5</p> <p>431 632</p> <p>..... 0111111-628888 ..... H 0111111-628888</p> <p>63/99 ..... 1-2-4-6-8 63/99 ..... H 1-2-4-6-8</p>	 <p><b>P386</b></p> <p>■</p> <p>6</p> <p>S681 S823 S830</p> <p>..... 1-2-3-4-Q-5-6-7-8-H ..... A-B-C-D-E-F</p>	 <p><b>P443</b></p> <p>●</p> <p>6</p> <p>S823 S830 S681 S850 S860 S903 S1336</p> <p>..... 1234Q5678H ..... ABCDEF ..... 12897-A9999</p>	 <p>●</p> <p>6</p> <p>S681 S823 S830 S850 S860 S903 S1336</p> <p>..... 12897-A9999 ..... ABCDEF ..... 1234Q5678H</p>
 <b>SX9MH</b>	 <b>VA2T14</b>	 <b>VA6MH</b>	 <b>VA6FH</b>

**HUF - VALEO**

**HUF - VALEO**



FOR:  
PER:

# CITROËN

**P293**  
288

**P443**  
288

**P315**  
431  
632

**P449**  
431  
632

**P443**  
431  
632

0111111-628888  
..... H  
0111111-628888  
63/99 ..... 1-2-4-6-8  
63/99 ..... H 1-2-4-6-8

0111111-628888  
..... H  
0111111-628888  
63/99 ..... 1-2-4-6-8  
63/99 ..... H 1-2-4-6-8

0111111-628888  
..... H  
0111111-628888  
63/99 ..... 1-2-4-6-8  
63/99 ..... H 1-2-4-6-8

**TE KEY**  
**MIT11RTE**  
..... 30010-32009

**MH KEY**  
**MIT11RMH**  
..... 30010-32009

**FH FLIP**  
**MIT11RFH**  
..... 30010-32009

**SX9T14**

**TE KEY**  
**SX9TE**

**MH KEY**  
**SX9MH**

**SIMPLEX**

FOR:  
PER:

# CITROËN

**P386**  
S681  
S823  
S830

**P454**  
S620  
S767  
S1117

**P443**  
S620  
S1117

**P443**  
S823  
S830  
S681  
S850  
S860  
S903  
S1336

S681  
S823  
S830  
S850  
S860  
S903  
S1336

**VA2T14**  
..... 1-2-3-4-Q-5-6-7-8-H  
..... A-B-C-D-E-F

**TE KEY**  
**HU83TE**  
..... 1-2000

**MH KEY**  
**HU83MH**  
..... 1-2000

**FH FLIP**  
**HU83FH**  
..... 1-2000

**MH KEY**  
**VA6MH**  
..... 1234Q5678H  
..... ABCDEF  
..... 12897-A9999

**FH FLIP**  
**VA6FH**  
..... 12897-A9999  
..... ABCDEF  
..... 1234Q5678H

**VALEO**

**VALEO**

**VALEO**



FOR:  
PER:

# CITROËN



**P247**  
■  
4+5  
431  
632

.....  
0111111-628888  
..... H  
0111111-628888  
63/99 ..... 1-2-4-6-8  
63/99 ..... H 1-2-4-6-8

**SX9CP**

**SIMPLEX**

**P315**  
■  
4+5  
431  
632

.....  
0111111-628888  
..... H  
0111111-628888  
63/99 ..... 1-2-4-6-8  
63/99 ..... H 1-2-4-6-8

**SX9T5**

**SX9T14**

**P449**  
■  
4+5  
431  
632

.....  
0111111-628888  
..... H  
0111111-628888  
63/99 ..... 1-2-4-6-8  
63/99 ..... H 1-2-4-6-8

**SX9TE**

**SIMPLEX**

**P443**  
■  
4+5  
431  
632

.....  
0111111-628888  
..... H  
0111111-628888  
63/99 ..... 1-2-4-6-8  
63/99 ..... H 1-2-4-6-8

**SX9MH**

**SIMPLEX**

**P128**  
▲ ●  
6/7  
108  
283  
437

N ..... 6001-7000  
..... 6001-7000  
V ..... 1-3056  
..... 3001-4000  
J ..... 3001-6732  
V ..... 5001-8058  
AB ..... 6001-6891

**GT10P**

**GIOBERT**

FOR:  
PER:

# CITROËN

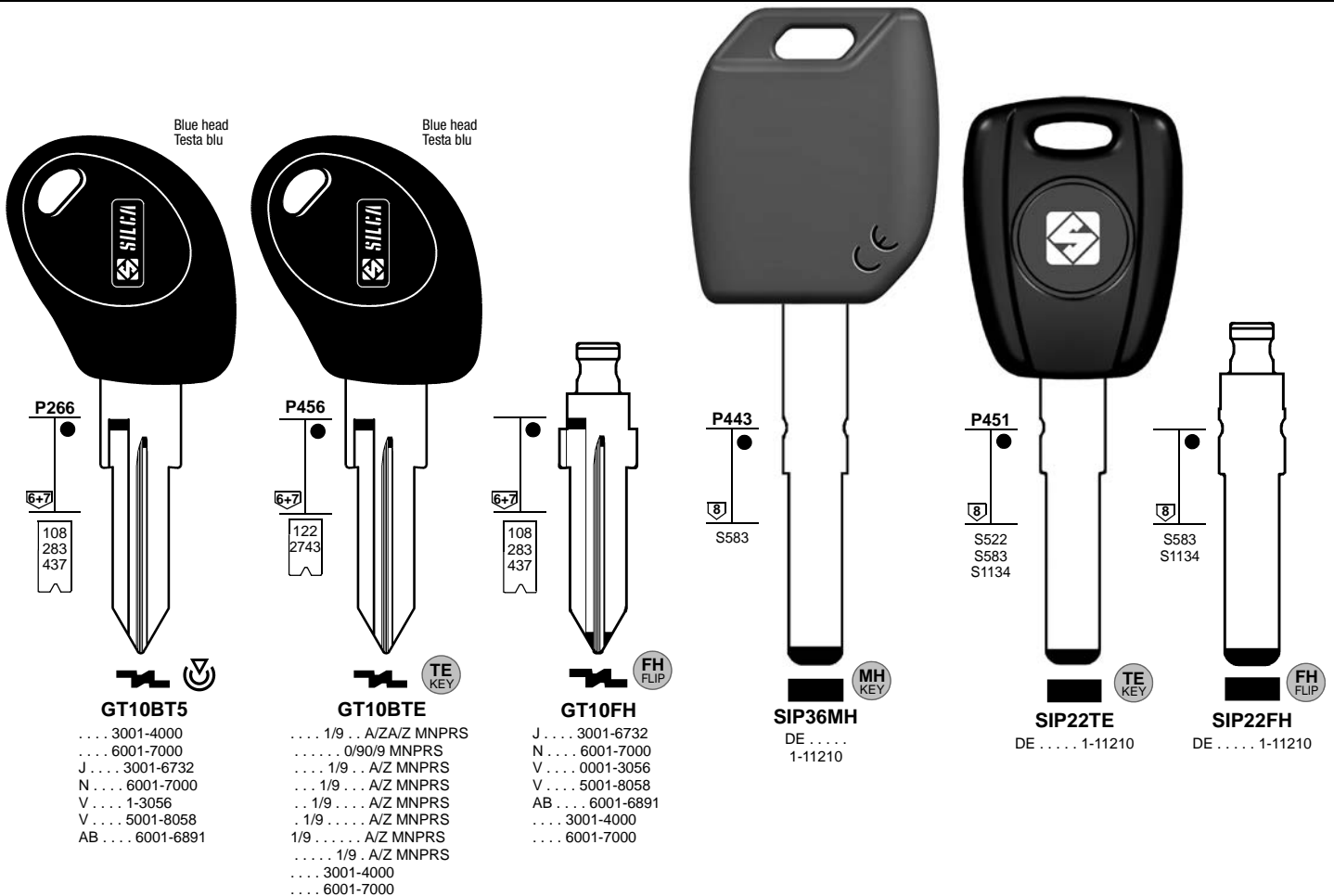

**P266**  
●  
6+7  
108  
283  
437

**GT10BT5**  
..... 3001-4000  
..... 6001-7000  
J ..... 3001-6732  
N ..... 6001-7000  
V ..... 1-3056  
V ..... 5001-8058  
AB ..... 6001-6891

**GIOBERT - TRW SIPEA**

Blue head  
Testa blu

**P456**  
●  
6+7  
122  
2743

**GT10BTE**  
..... 1/9 .. A/Z/A/Z MNPRS  
..... 0/90/9 MNPRS  
..... 1/9 .. A/Z MNPRS  
..... 1/9 .. A/Z MNPRS  
..... 1/9 .. A/Z MNPRS  
..... 1/9 .. A/Z MNPRS  
..... 1/9 .. A/Z MNPRS  
..... 1/9 .. A/Z MNPRS  
..... 3001-4000  
..... 6001-7000

**P443**  
●  
6+7  
108  
283  
437

**GT10FH**  
J ..... 3001-6732  
N ..... 6001-7000  
V ..... 0001-3056  
V ..... 5001-8058  
AB ..... 6001-6891  
..... 3001-4000  
..... 6001-7000

**P443**  
●  
8  
S583

**SIP36MH**  
DE .....  
1-11210

**GIOBERT - TRW SIPEA**

Blue head  
Testa blu

**P451**  
●  
8  
S522  
S583  
S1134

**SIP22TE**  
DE ..... 1-11210

**GIOBERT - TRW SIPEA**

**P451**  
●  
8  
S583  
S1134

**SIP22FH**  
DE ..... 1-11210



FOR:  
PER:

# CITROËN

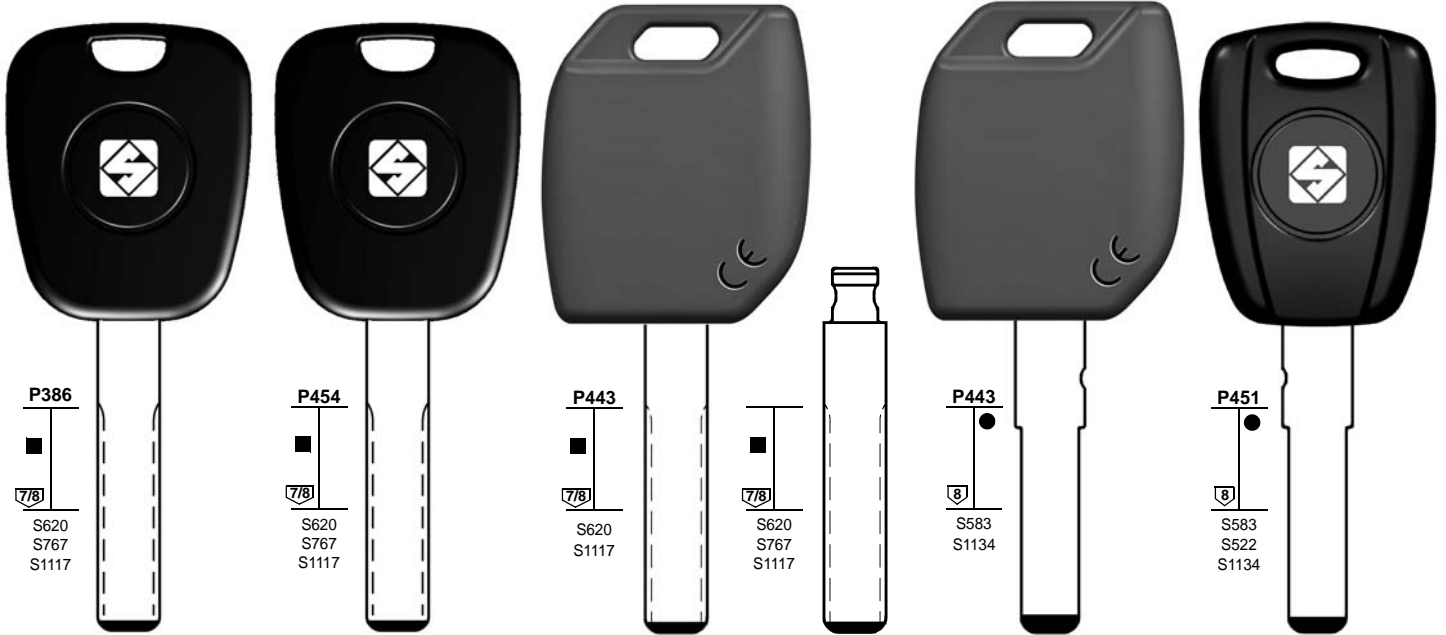

P386

P454

P443

P443

P451

■  
7/8  
S620  
S767  
S1117

■  
7/8  
S620  
S767  
S1117

■  
7/8  
S620  
S1117

■  
7/8  
S620  
S767  
S1117

●  
8  
S583  
S1134

●  
8  
S583  
S522  
S1134

**HU83T14**  
.... 1-2000

**HU83TE**  
.... 1-2000

**HU83MH**  
.... 1-2000

**HU83FH**  
.... 1-2000

**SIP22MH**  
DE ..... 1-11210

**SIP22TE**  
DE ..... 1-11210

HUF - VALEO

HUF - VALEO

GIOBERT - TRW SIPEA

FOR:  
PER:

# CITROËN

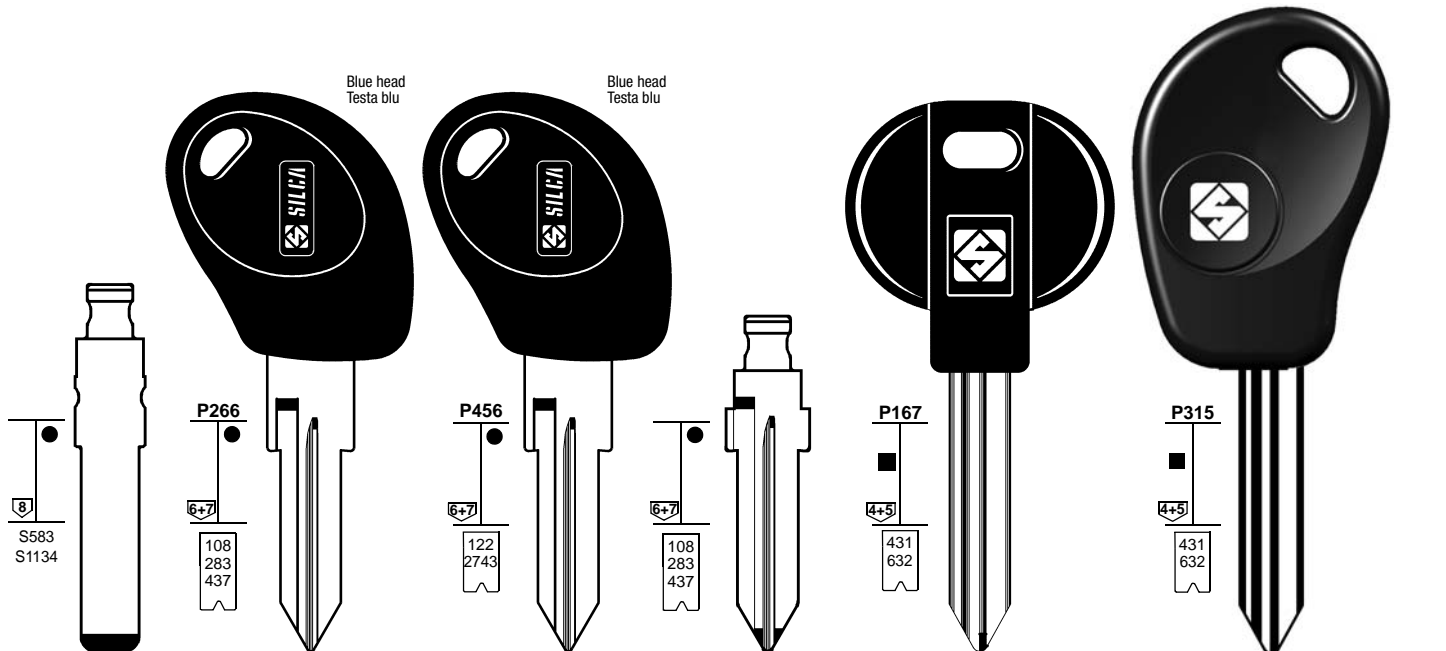

Blue head  
Testa blu

Blue head  
Testa blu

●  
8  
S583  
S1134

●  
6+7  
108  
283  
437

●  
6+7  
122  
2743

●  
6+7  
108  
283  
437

■  
4+5  
431  
632

■  
4+5  
431  
632

**SIP22FH**  
DE ..... 1-11210

**GT10BT5**  
.... 3001-4000  
.... 6001-7000  
J ..... 3001-6732  
N ..... 6001-7000  
V ..... 1-3056  
V ..... 5001-8058  
AB ..... 6001-6891

**GT10BTE**  
.... 1/9 ... A/Z MNPRS  
.... 0/90/9 MNPRS  
.... 1/9 ... A/Z MNPRS  
.... 1/9 ... A/Z MNPRS  
.... 1/9 ... A/Z MNPRS  
.... 1/9 ... A/Z MNPRS  
.... 1/9 ... A/Z MNPRS  
.... 3001-4000  
.... 6001-7000

**GT10FH**  
J ..... 3001-6732  
N ..... 6001-7000  
V ..... 5001-8058  
AB ..... 6001-6891  
.... 3001-4000  
.... 6001-7000

**SX9AP**  
63/99 ..... H 12468  
63/99 ..... 12468  
..... H 0111111-628888  
..... 0111111-628888

**SX9T5**  
.....  
0111111-628888  
..... H  
0111111-628888  
63/99 ..... 1-2-4-6-8  
63/99 ..... H 1-2-4-6-8

**SX9T14**

GIOBERT - TRW SIPEA

GIOBERT - TRW SIPEA

GIOBERT - TRW SIPEA

SIMPLEX





FOR:  
PER:

# CITROËN

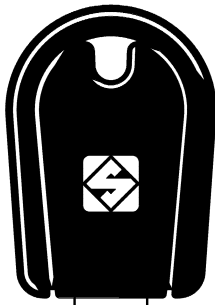

M-N-P-R-S



NE72LP

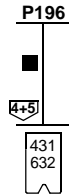
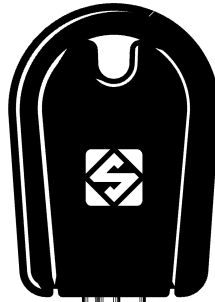

0111111-628888  
..... H  
0111111-628888  
63/99 ..... 1-2-4-6-8  
63/99 ..... H 1-2-4-6-8



SX9GP

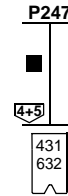
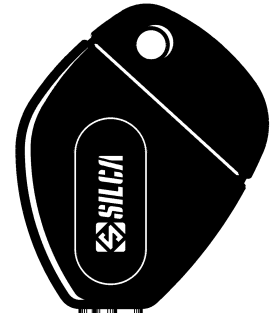

0111111-628888  
..... H  
0111111-628888  
63/99 ..... 1-2-4-6-8  
63/99 ..... H 1-2-4-6-8



SX9CP

SIMPLEX

FOR:  
PER:

# CITROËN

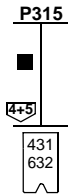

0111111-628888  
..... H  
0111111-628888  
63/99 ..... 1-2-4-6-8  
63/99 ..... H 1-2-4-6-8



SX9T5



0111111-628888  
..... H  
0111111-628888  
63/99 ..... 1-2-4-6-8  
63/99 ..... H 1-2-4-6-8

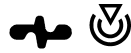

SX9T14



SX9T6

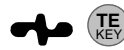

SX9TE



0111111-628888  
..... H  
0111111-628888  
63/99 ..... 1-2-4-6-8  
63/99 ..... H 1-2-4-6-8



SX9MH

SIMPLEX

SIMPLEX



FOR:  
PER:

# DAIHATSU

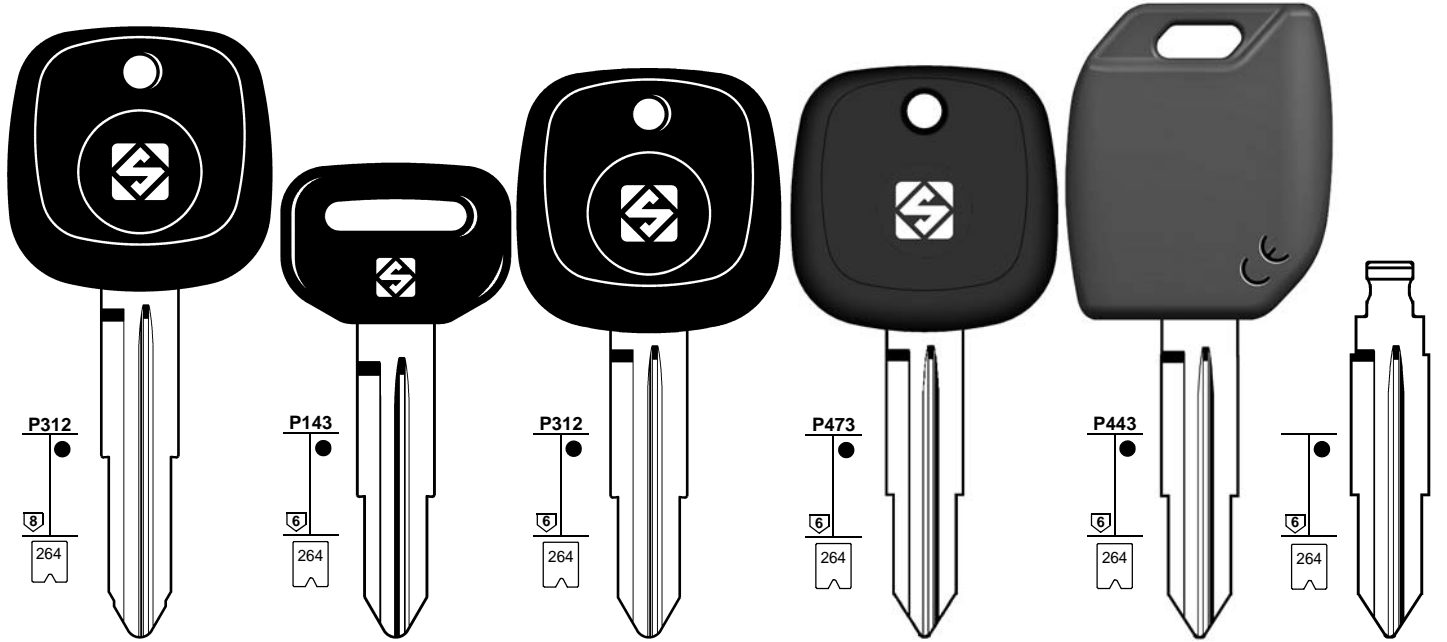

  
**DH4RT4**  
D . . . . 1-3000

  
**DH5RP**  
D . . . . 3001-4000

  
**DH5RT4**  
D . . . . 3001-4000

 **TE KEY**  
**DH5RTE**  
D . . . . 3001-4000

 **MH KEY**  
**DH5RMH**  
D . . . . 3001-4000

  
**DH5RFH**  
D . . . . 1-3000

FOR:  
PER:

# DAIHATSU

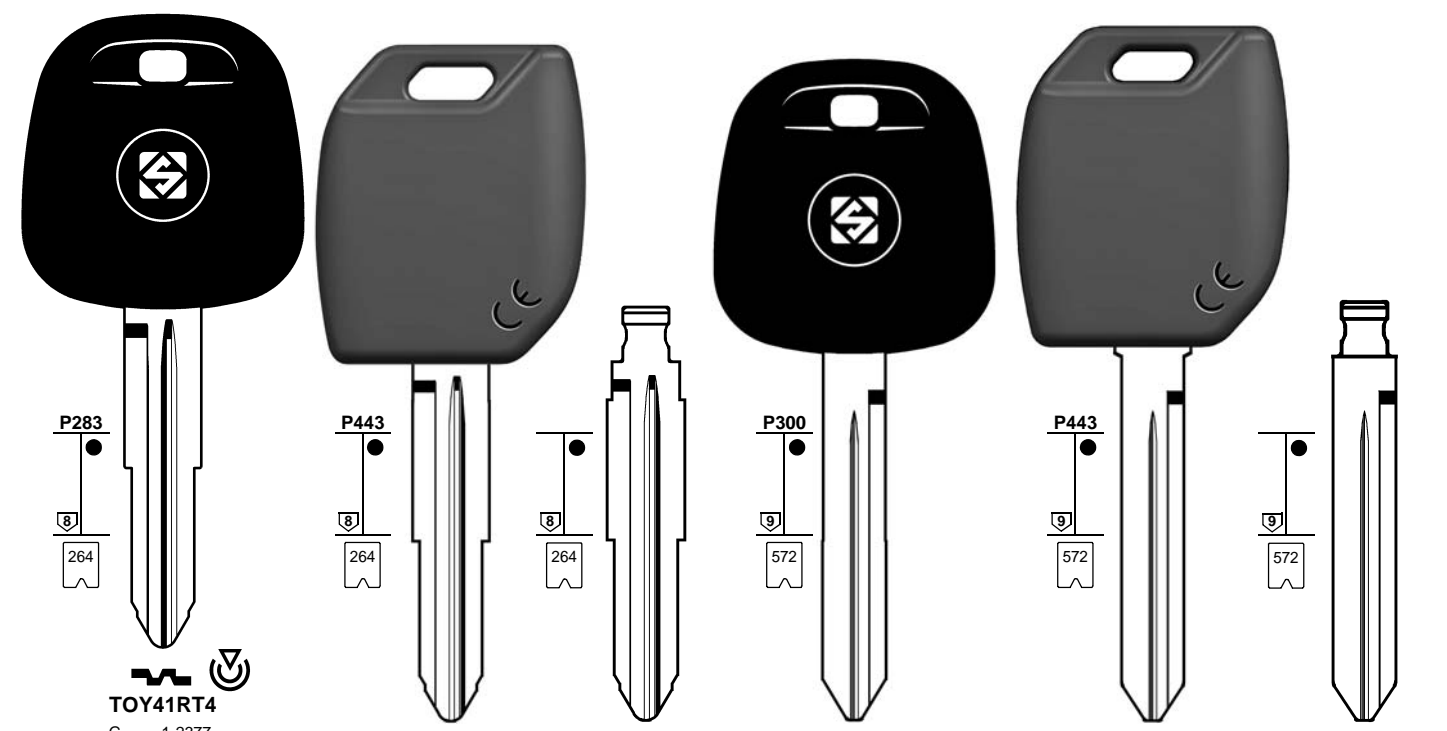

  
**TOY41RT4**  
G . . . . 1-2377  
P . . . . 1-2390  
X . . . . 1-2248

 **TE KEY**  
**TOY41RTE**  
D . . . . 1-3000  
G . . . . 1-2377  
P . . . . 1-2390  
X . . . . 1-2248

 **MH KEY**  
**TOY41RMH**  
D . . . . 1-3000  
D . . . . 3001-4000  
G . . . . 1-2377  
P . . . . 1-2390  
X . . . . 1-2248

 **FH FLIP**  
**TOY41RFH**  
G . . . . 1-2377  
P . . . . 1-2390  
X . . . . 1-2248

 **TE KEY**  
**TOY47TE**  
. . . . . 1-13284  
T . . . . 1-13284

 **MH KEY**  
**TOY47MH**  
. . . . . 1-13284  
T . . . . 1-13284

 **FH FLIP**  
**TOY47FH**  
. . . . . 1-13284  
T . . . . 1-13284



FOR:  
PER:

# DODGE

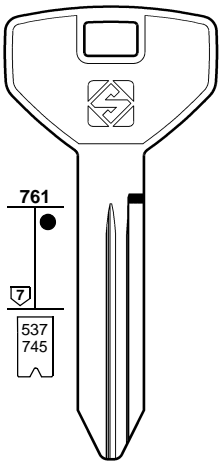

761

537  
745

**CY23**

M . . . . 1-2618  
L . . . . 1-3580

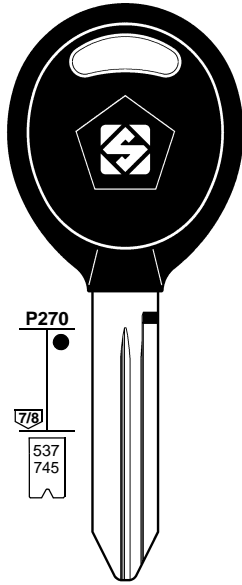

P270

537  
745

**CY24BP**

L . . . . 1-3580  
M . . . . 1-2618

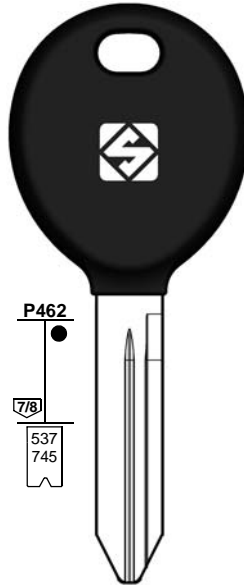

P462

537  
745

**CY24TE**

L . . . . 1-3580  
M . . . . 1-2618

TE  
KEY

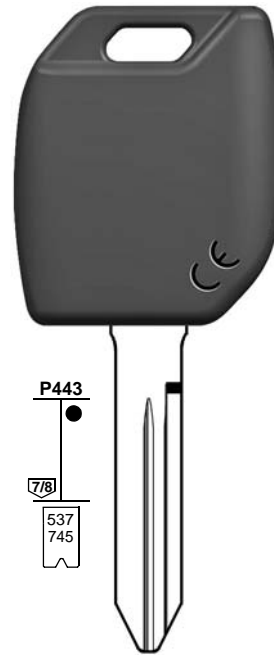

P443

537  
745

**CY24MH**

L . . . . 1-3580  
M . . . . 1-2618

MH  
KEY

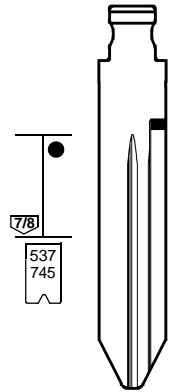

537  
745

**CY24FH**

L . . . . 1-3580  
M . . . . 1-2618  
FT . . . . 1001-3000

FH  
FLIP

MITSUBISHI

MITSUBISHI

MITSUBISHI

FOR:  
PER:

# DODGE

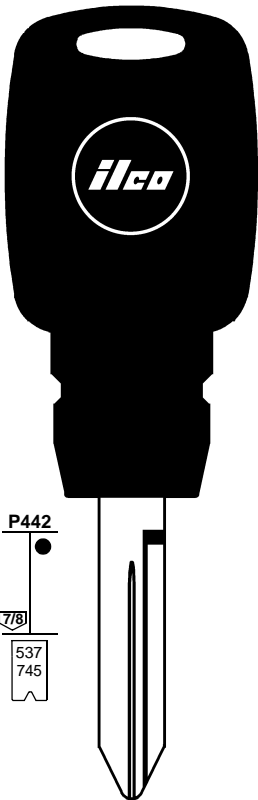

P442

537  
745

**EK3P-Y170**

L . . . . 1-3580  
M . . . . 1-2618

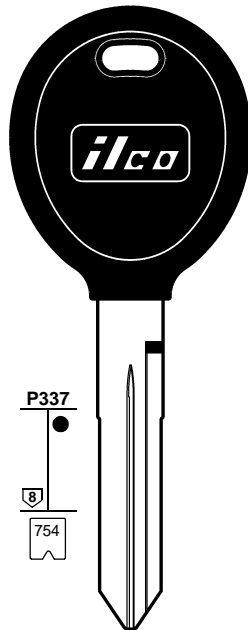

P337

754

**Y162-PT**

M . . . . 1-2618

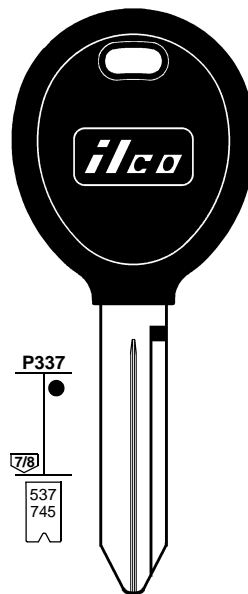

P337

537  
745

**Y164-PT**

L . . . . 1-3580  
M . . . . 1-2618

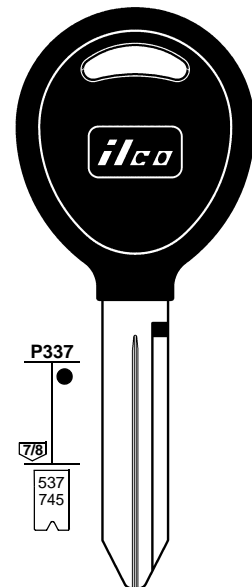

P337

537  
745

**Y160-PT**

L . . . . 1-3580  
M . . . . 1-2618

1	2	2a	3	3a	3b	e1+e2		6	42+71	72	43+44a	12	15
						GTI COMPATIBLE		IGNITION					
CAR MAKE MODEL	FROM	TO	SILCA REF.	SILCA REF.	SILCA REF.	COPY	GEN.	TRANSP. TYPE	FAST COPY PLUS RW4 PLUS FAST COPY/RW4	FAST COPY PLUS RW4 PLUS	FAST COPY RW4	STP	
For more info on the uses of car keys, refer to the Silca Electronic Keys Catalogue:													
<b>DODGE</b>													
AVENGER	2008		Y164-PT					PH / CR2	46				F
AVENGER	2008		CY24MH	CY24TE	CY24FH	Y	Y	PH / CR2	46	Y	P-BOX		
CALIBER	2007	2012	Y164-PT					PH / CR2	46				
CALIBER	2007	2012	CY24MH	CY24TE	CY24FH	Y	Y	PH / CR2	46	Y	P-BOX		
CARAVAN	2001	2003	Y160-PT					TEX / CR	64				F
CARAVAN	2001	2003	CY24MH	CY24TE	CY24FH	Y	Y	TEX / CR	64	Y	P-BOX		
CARAVAN	2004	2007	Y164-PT					PH / CR2	46				
CARAVAN	2004	2007	CY24MH	CY24TE	CY24FH	Y	Y	PH / CR2	46	Y	P-BOX		
CARAVAN	2008							PH / CR2	46				
CARAVAN	2008		EK3P-Y170					PH / CR2	46	Y	P-BOX		
CHALLENGER	2008	2011						PH / CR2	46				
CHALLENGER	2008		EK3P-Y170					PH / CR2	46	Y	P-BOX		
CHALLENGER	2012		SMARTKEY					PH / CR2	46				
CHARGER	2005	2008	Y164-PT					PH / CR2	46				
CHARGER	2005	2008	CY24MH	CY24TE	CY24FH	Y	Y	PH / CR2	46	Y	P-BOX		
CHARGER	2008							PH / CR2	46				
CHARGER	2008		EK3P-Y170					PH / CR2	46	Y	P-BOX		
CHARGER	2012		SMARTKEY					PH / CR2	46				
DAKOTA	2001	2004	Y160-PT					TEX / CR	64				F
DAKOTA	2001	2004	CY24MH	CY24TE	CY24FH	Y	Y	TEX / CR	64	Y	P-BOX		
DAKOTA	2005	2011	Y164-PT					PH / CR2	46				F
DAKOTA	2005	2011	CY24MH	CY24TE	CY24FH	Y	Y	PH / CR2	46	Y	P-BOX		
DART	2013		EK3P-Y170					PH / CR2	46	Y	P-BOX		
DART	2013							PH / CR2	46				
DURANGO	2001	2004	Y160-PT					TEX / CR	64				F
DURANGO	2001	2004	CY24MH	CY24TE	CY24FH	Y	Y	TEX / CR	64	Y	P-BOX		
DURANGO	2005	2009	Y164-PT					PH / CR2	46				
DURANGO	2005	2009	CY24MH	CY24TE	CY24FH	Y	Y	PH / CR2	46	Y	P-BOX		
DURANGO	2011							PH / CR2	46				
DURANGO	2011		EK3P-Y170					PH / CR2	46	Y	P-BOX		
INTREPID	1998	2004	Y160-PT					TEX / CR	64				F
INTREPID	1998	2004	CY24MH	CY24TE	CY24FH	Y	Y	TEX / CR	64	Y	P-BOX		
INTREPID	1998	2004	CY24BP										
INTREPID	1998	2001	CY23										
INTREPID SEDAN, ES	2001	2004	Y160-PT					TEX / CR	64				F
INTREPID SEDAN, ES	2001	2004	CY24MH	CY24TE	CY24FH	Y	Y	TEX / CR	64	Y	P-BOX		
JOURNEY	2008	2011						PH / CR2	46				
JOURNEY	2008		EK3P-Y170					PH / CR2	46	Y	P-BOX		
JOURNEY	2012		SMARTKEY					PH / CR2	46				
MAGNUM	2005	2008	Y164-PT					PH / CR2	46				F
MAGNUM	2005	2008	CY24MH	CY24TE	CY24FH	Y	Y	PH / CR2	46	Y	P-BOX		
MAGNUM	2008	2009						PH / CR2	46				
MAGNUM	2008	2009	EK3P-Y170					PH / CR2	46	Y	P-BOX		
NEON	2000	2005	Y160-PT					TEX / CR	64				F
NEON	2000	2005	CY24MH	CY24TE	CY24FH	Y	Y	TEX / CR	64	Y	P-BOX		
NITRO	2007	2012	Y164-PT					PH / CR2	46				F

FOR:  
PER:

## DODGE

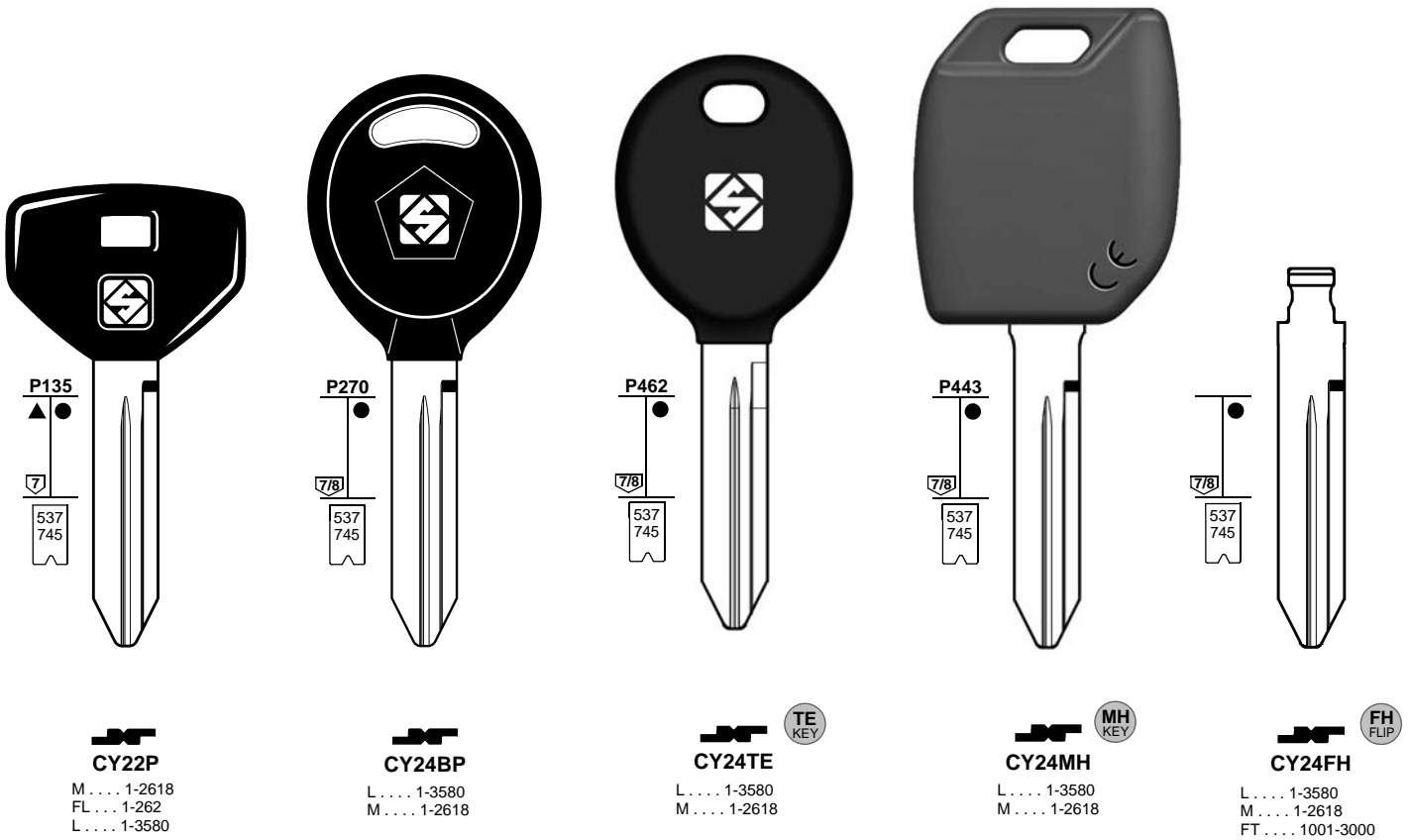

**CY22P**

M . . . . 1-2618  
FL . . . . 1-262  
L . . . . 1-3580

**CY24BP**

L . . . . 1-3580  
M . . . . 1-2618

**CY24TE**

L . . . . 1-3580  
M . . . . 1-2618

**CY24MH**

L . . . . 1-3580  
M . . . . 1-2618

**CY24FH**

L . . . . 1-3580  
M . . . . 1-2618  
FT . . . . 1001-3000

MITSUBISHI

MITSUBISHI

MITSUBISHI

FOR:  
PER:

## DODGE



**YM15T5**

. . . NF . . . 1-99 . . . 1-99  
HM . . . . 1-1200  
HM . . . . 2501-3500  
HM . . . . 4001-7350  
HM . . . . 6001-7109  
NF . . . . 1-1200  
NM . . . . 2501-3500

**YM15FH**

NM . . . . 2501-3500  
. . . NF . . . 1-99 . . . 1-99  
HM . . . . 1-1200  
HM . . . . 2501-3500  
HM . . . . 4001-7350  
HF . . . . 1-1200

**Y162-PT**

M . . . . 1-2618

**Y164-PT**

L . . . . 1-3580  
M . . . . 1-2618

**Y160-PT**

L . . . . 1-3580  
M . . . . 1-2618

**EK3P-Y170**

L . . . . 1-3580  
M . . . . 1-2618

VALEO - YMOS





FOR:  
PER:

# EAGLE

# FIAT

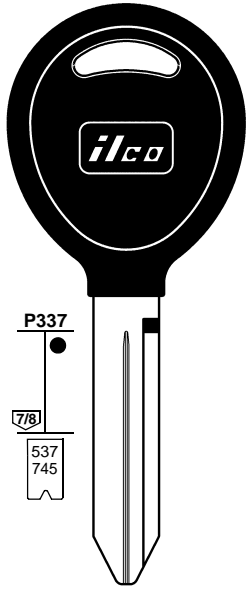

P337  
7/8  
537  
745

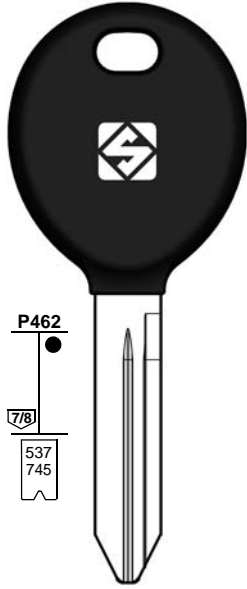

P462  
7/8  
537  
745

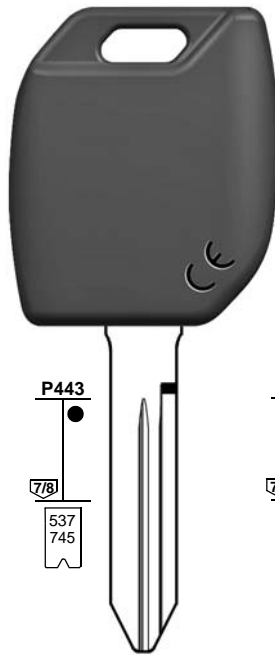

P443  
7/8  
537  
745

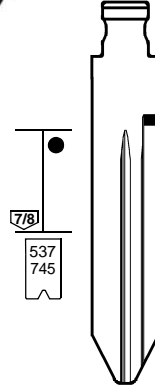

P443  
7/8  
537  
745

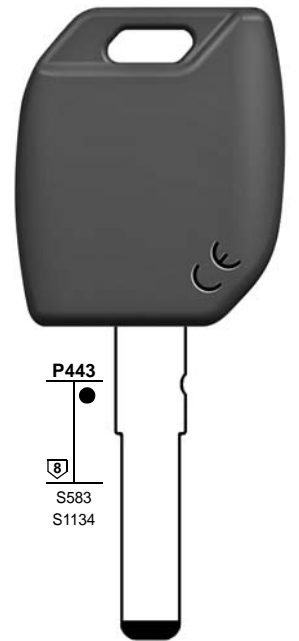

P443  
8  
S583  
S1134

**Y160-PT**  
L . . . . 1-3580  
M . . . . 1-2618

**CY24TE** **TE KEY**  
L . . . . 1-3580  
M . . . . 1-2618

**CY24MH** **MH KEY**  
L . . . . 1-3580  
M . . . . 1-2618

**CY24FH** **FH FLIP**  
L . . . . 1-3580  
M . . . . 1-2618  
FT . . . . 1001-3000

**SIP22MH** **MH KEY**  
DE . . . . 1-11210

MITSUBISHI

MITSUBISHI

GIOBERT - TRW SIPEA

FOR:  
PER:

# FIAT

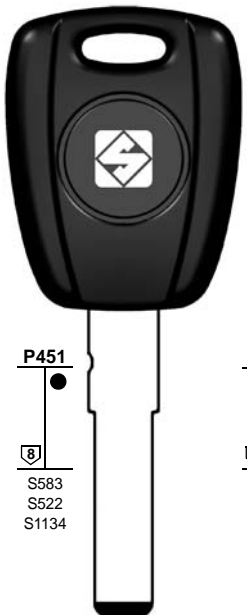

P451  
8  
S583  
S522  
S1134

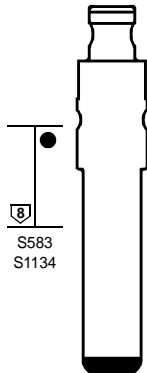

P451  
8  
S583  
S1134

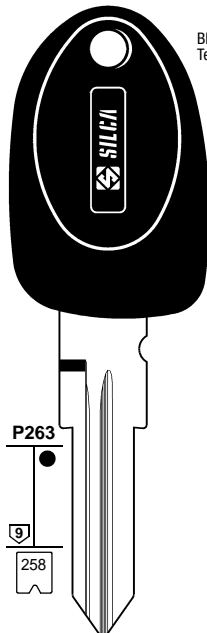

P263  
9  
258

Blue head  
Testa blu

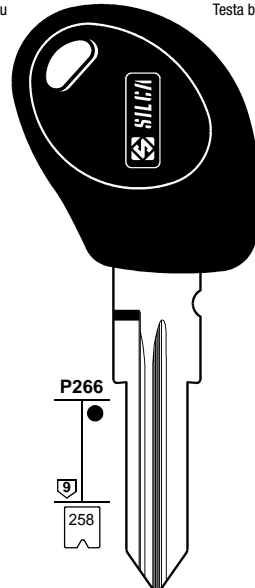

P266  
9  
258

Blue head  
Testa blu

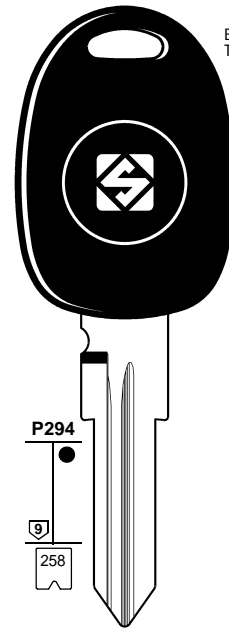

P294  
9  
258

Blue head  
Testa blu

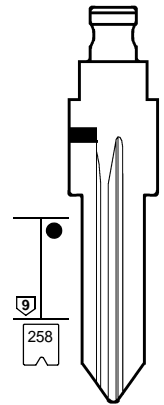

P294  
9  
258

**SIP22TE** **TE KEY**  
DE . . . . 1-11210

**SIP22FH** **FH FLIP**  
DE . . . . 1-11210

**GT15RAT5**  
W . . . .  
0001-9640

**GT15RBT5**  
W . . . .  
0001-9640

**GT15RCT5**  
W . . . .  
0001-9640

**GT15RFH** **FH FLIP**  
W . . . .  
0001-9640

GIOBERT - TRW SIPEA

GIOBERT - TRW SIPEA

GIOBERT - TRW SIPEA



FOR:  
PER:

# FIAT

**P443**  
S583  
S1134

**P451**  
S583  
S522  
S1134

S583  
S1134

**P387**  
S583

**SIP22KP**

The SIP22KP key can be also purchased in 5-piece packages.  
*La chiave SIP22KP può essere acquistata anche in confezioni da 5 pezzi.*  
Der Schlüssel SIP22KP kann auch in Pakungen mit 5 Stücke gekauft werden.  
*La clé SIP22KP peut même être commandée sous confection de 5 pcs.*  
La llave SIP22KP se puede comprar en paquetes de 5 piezas.  
*As chave SIP22KP podem ser compradas em pacotes de 5 unidades.*

**MH KEY**  
**SIP22MH**  
DE . . . . . 1-11210

**TE KEY**  
**SIP22TE**  
DE . . . . . 1-11210

**FH FLIP**  
**SIP22FH**  
DE . . . . . 1-11210

**KIT KEYS**  
**SIP22TEK**  
(old SIP22MHK Reference)

GIOBERT - TRW SIPEA

FOR:  
PER:

# FIAT

Blue head  
Testa blu

Blue head  
Testa blu

Blue head  
Testa blu

Blue head  
Testa blu

**P266**  
108  
283  
437

**P456**  
122  
2743

108  
283  
437

**P263**  
258

**P266**  
258

258

**GT10BT5**  
... 3001-4000  
... 6001-7000  
J . . . . . 3001-6732  
N . . . . . 6001-7000  
V . . . . . 1-3056  
V . . . . . 5001-8058  
AB . . . . . 6001-6891

**TE KEY**  
**GT10BTE**  
... 1/9 . . . A/Z/MNPRS  
... 0/90/9 MNPRS  
... 1/9 . . . A/Z MNPRS  
... 1/9 . . . A/Z MNPRS  
... 1/9 . . . A/Z MNPRS  
... 1/9 . . . A/Z MNPRS  
... 1/9 . . . A/Z MNPRS  
... 1/9 . . . A/Z MNPRS  
... 3001-4000  
... 6001-7000

**FH FLIP**  
**GT10FH**  
J . . . . . 3001-6732  
N . . . . . 6001-7000  
V . . . . . 0001-3056  
V . . . . . 5001-8058  
AB . . . . . 6001-6891  
... 3001-4000  
... 6001-7000

**GT15RAT5**  
W . . . . . 0001-9640

**GT15RBT5**  
W . . . . . 0001-9640

**FH FLIP**  
**GT15RFH**  
W . . . . . 0001-9640

GIOBERT - TRW SIPEA

GIOBERT - TRW SIPEA

GIOBERT - TRW SIPEA



FOR:  
PER:

# FIAT

Blue head Testa blu

Blue head Testa blu

P443  
S583

P443  
S583  
S1134

P451  
S583  
S522  
S1134

S583  
S1134

P301  
258

P294  
258

**SIP36MH**  
MH KEY  
DE .....  
1-11210

**SIP22MH**  
MH KEY  
DE .....  
1-11210

**SIP22TE**  
TE KEY  
DE .....  
1-11210

**SIP22FH**  
FH FLIP  
DE .....  
1-11210

**GT15RCP**  
W ....  
0001-9640

**GT15RCT5**  
W ....  
0001-9640

GIOBERT - TRW SIPEA

GIOBERT - TRW SIPEA

GIOBERT - TRW SIPEA

FOR:  
PER:

# FIAT

Blue head Testa blu

Blue head Testa blu

Blue head Testa blu

Blue head Testa blu

P263  
258

P266  
258

258

P266  
108  
283  
437

P456  
122  
2743

108  
283  
437

**GT15RAT5**  
W ....  
0001-9640

**GT15RBT5**  
W ....  
0001-9640

**GT15RFH**  
FH FLIP  
W ....  
0001-9640

**GT10BT5**  
W ....  
3001-4000  
6001-7000  
J .... 3001-6732  
N .... 6001-7000  
V .... 1-3056  
AB .... 5001-8058  
6001-6891

**GT10BTE**  
TE KEY  
W ....  
1/9 ... A/Z MNPRS  
0/90/9 MNPRS  
1/9 ... A/Z MNPRS  
1/9 ... A/Z MNPRS  
1/9 ... A/Z MNPRS  
1/9 ... A/Z MNPRS  
1/9 ... A/Z MNPRS  
1/9 ... A/Z MNPRS  
3001-4000  
6001-7000

**GT10FH**  
FH FLIP  
J .... 3001-6732  
N .... 6001-7000  
V .... 0001-3056  
W .... 5001-8058  
AB .... 6001-6891  
3001-4000  
6001-7000

GIOBERT - TRW SIPEA

GIOBERT - TRW SIPEA

GIOBERT - TRW SIPEA



FOR:  
PER:

# FIAT

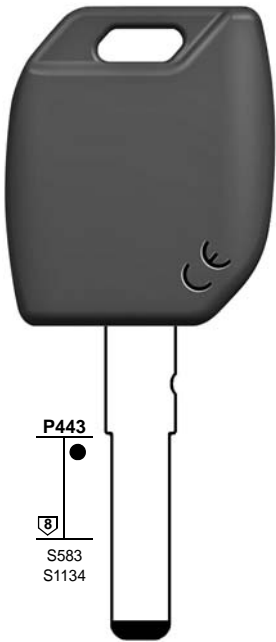

P443

S583  
S1134

**SIP22MH**  
DE . . . . .  
1-11210

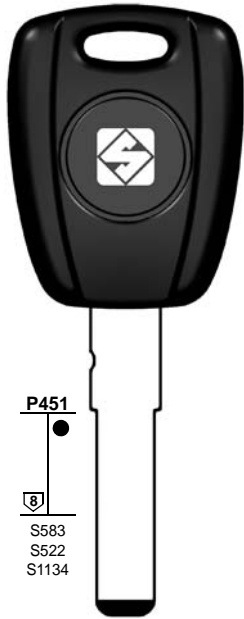

P451

S583  
S522  
S1134

**SIP22TE**  
DE . . . . .  
1-11210

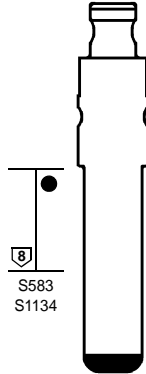

S583  
S1134

**SIP22FH**  
DE . . . . .  
1-11210

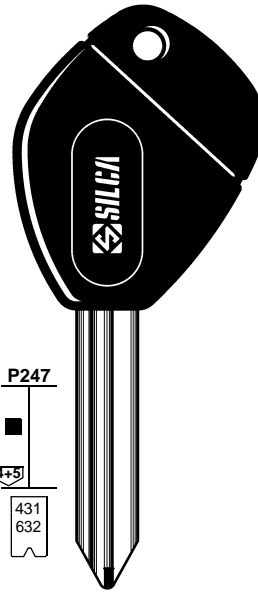

P247

431  
632

0111111-628888  
..... H  
0111111-628888  
63/99 . . . . . 1-2-4-6-8  
63/99 . . . . . H 1-2-4-6-8

**SX9CP**

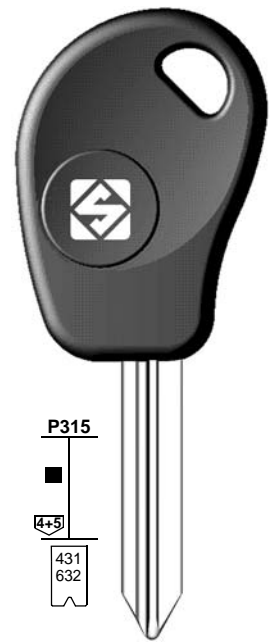

P315

431  
632

0111111-628888  
..... H  
0111111-628888  
63/99 . . . . . 1-2-4-6-8  
63/99 . . . . . H 1-2-4-6-8

**SX9T5**      **SX9T14**

GIOBERT - TRW SIPEA

GIOBERT - TRW SIPEA

SIMPLEX

FOR:  
PER:

# FIAT



P449

431  
632

**SX9TE**

0111111-628888  
..... H  
0111111-628888  
63/99 . . . . . 1-2-4-6-8  
63/99 . . . . . H 1-2-4-6-8

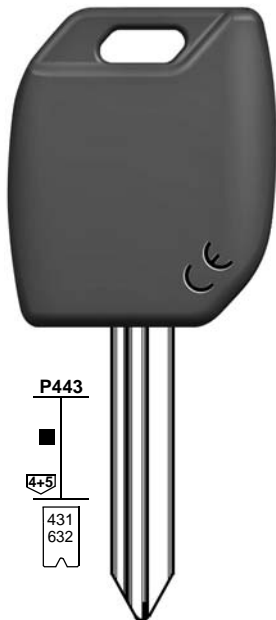

P443

431  
632

**SX9MH**

0111111-628888  
..... H  
0111111-628888  
63/99 . . . . . 1-2-4-6-8  
63/99 . . . . . H 1-2-4-6-8

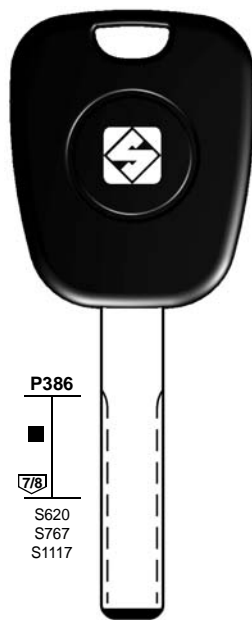

P386

S620  
S767  
S1117

**HU83TE**  
..... 1-2000

**HU83T14**  
..... 1-2000  
(head code P386)

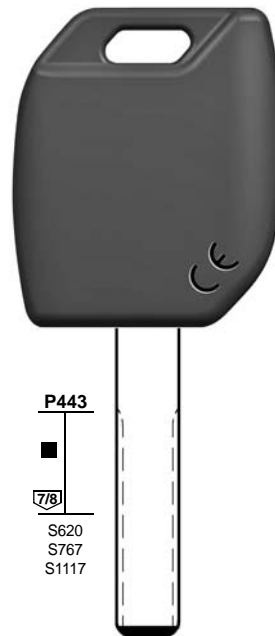

P443

S620  
S767  
S1117

**HU83MH**  
..... 1-2000

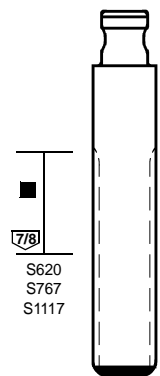

S620  
S767  
S1117

**HU83FH**  
..... 1-2000

VALEO

VALEO





FOR:  
PER:

# FIAT



**HU133RT12**  
..... 50001-51308

**HU133RT14**  
..... 50001-51308  
U ..... 1-2000  
IP ..... 5001-6308

HUF

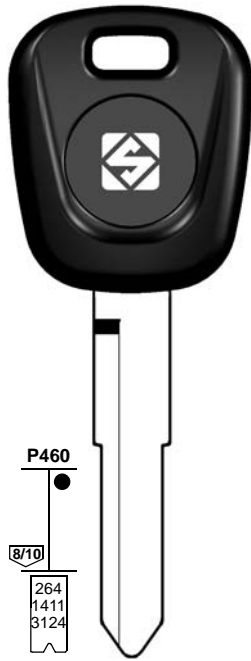

**HU133RTE**  
..... 50001-51308  
U ..... 1-2000  
IP ..... 5001-6308

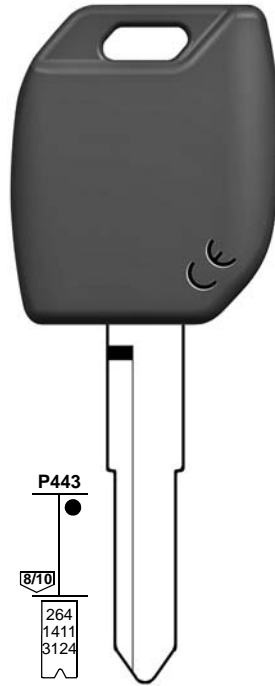

**HU133RMH**  
..... 50001-51308  
U ..... 1-2000  
IP ..... 5001-6308

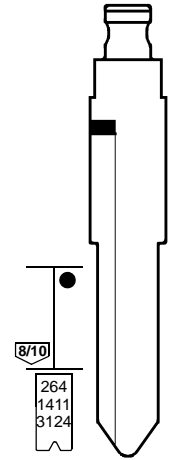

**HU133RFH**  
..... 50001-51308  
U ..... 1-2000  
IP ..... 5001-6308

HUF

FOR:  
PER:

# FIAT

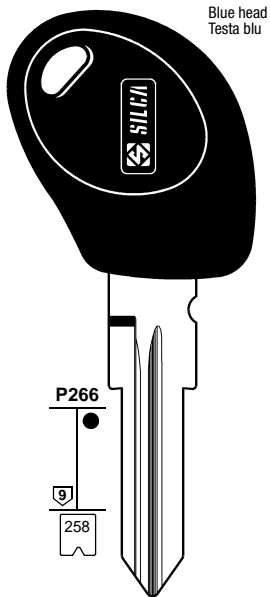

**GT15RBT5**  
W .....  
0001-9640

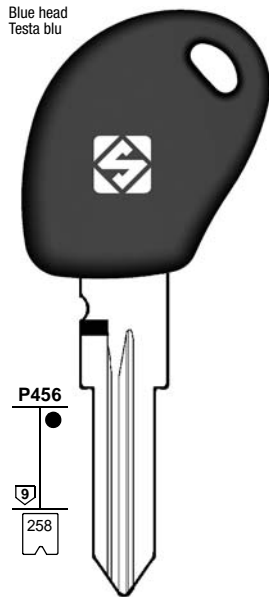

**GT15RBTE**  
W .....  
0001-9640

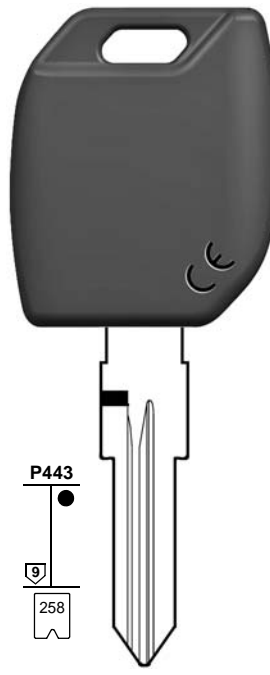

**GT15RMH**  
W .....  
0001-9640

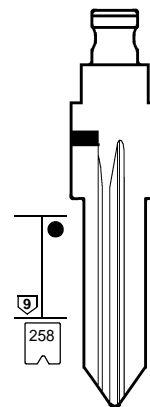

**GT15RFH**  
W .....  
0001-9640

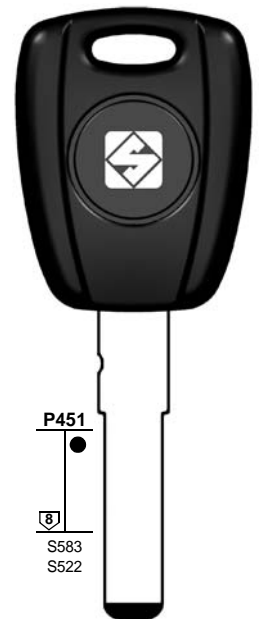

**SIP22LP**  
DE .....  
1-11210

GIOBERT - TRW SIPEA

GIOBERT - TRW SIPEA

GIOBERT - TRW SIPEA



FOR:  
PER:

# FIAT

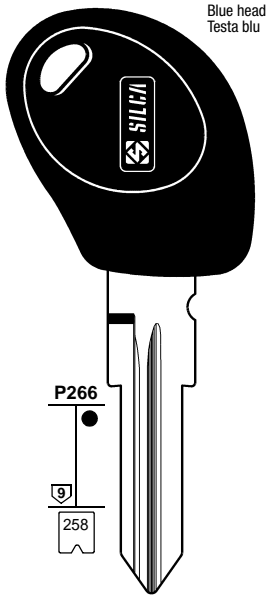

**GT15RBT5**  
W . . . .  
0001-9640

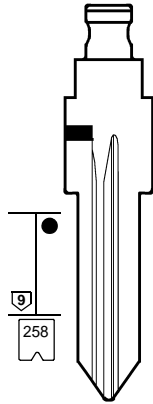

**GT15RFH**  
W . . . .  
0001-9640

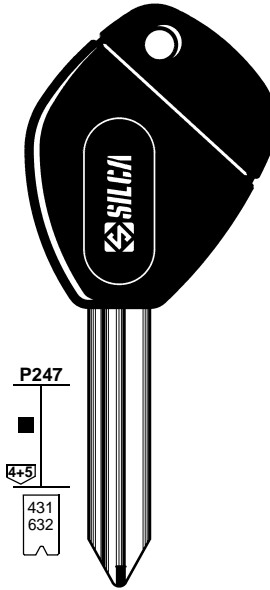

.....  
0111111-628888  
..... H  
0111111-628888  
63/99 ..... 1-2-4-6-8  
63/99 ..... H 1-2-4-6-8

**SX9CP**



.....  
0111111-628888  
..... H  
0111111-628888  
63/99 ..... 1-2-4-6-8  
63/99 ..... H 1-2-4-6-8

**SX9T5**

GIOBERT - TRW SIPEA

SIMPLEX

FOR:  
PER:

# FIAT

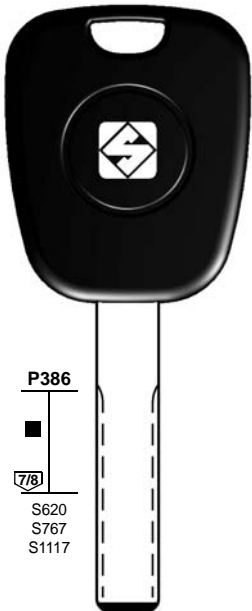

**HU83T14**  
..... 1-2000



**HU83TE**

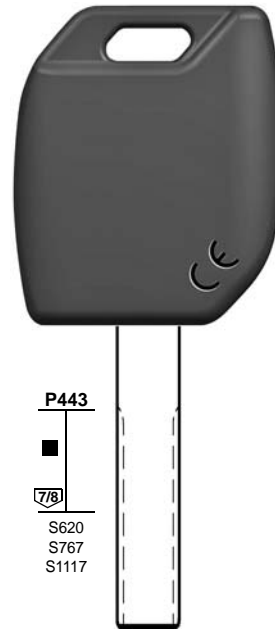

**HU83MH**  
..... 1-2000

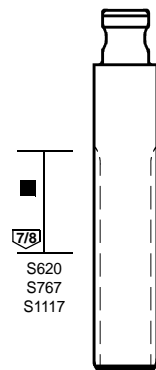

**HU83FH**  
..... 1-2000

VALEO

VALEO



FOR:  
PER:

## FORD AUS

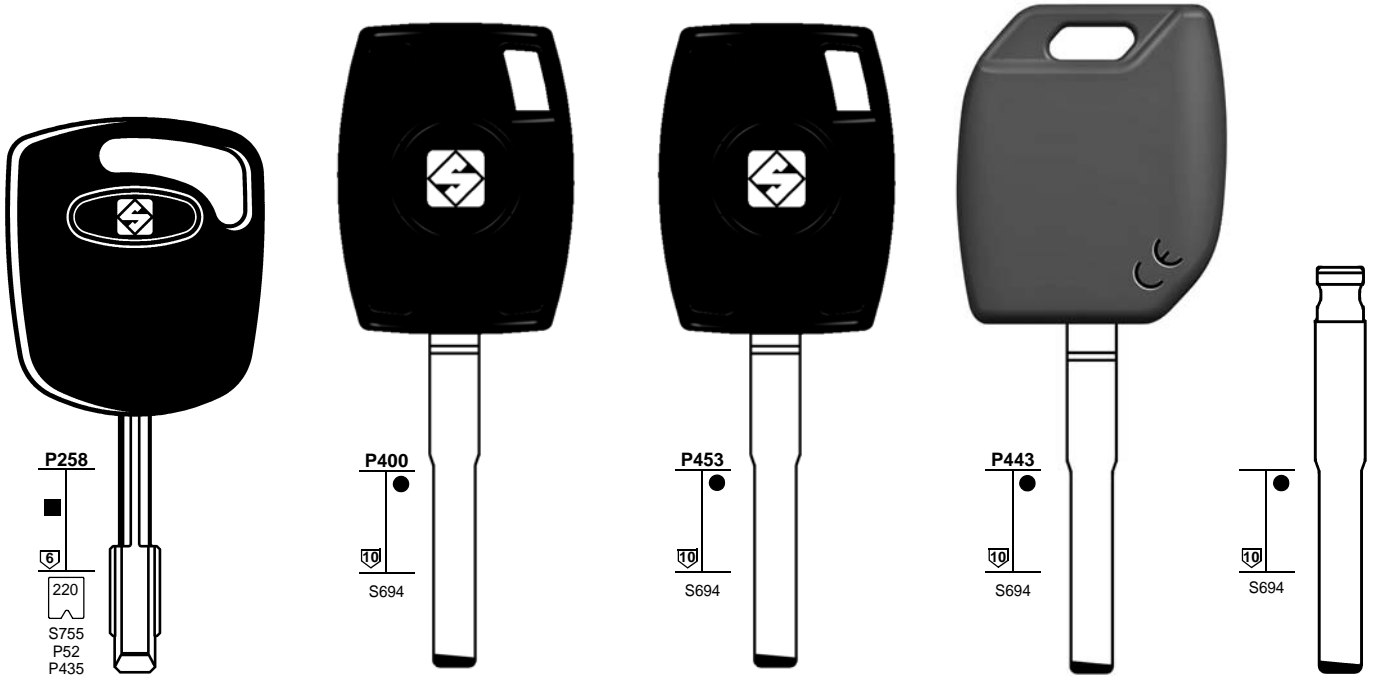

P258



220

S755  
P52  
P435

P400



S694

P453



S694

P443



S694



S694



**FO21T3**

T . . . . 1-1050  
T . . . . 1-2330  
T . . . . 1051-2330  
T . . . . . 1-2-3-4



**HU101T20**

. . . . 1-4000



**HU101TE**

. . . . 1-4000



**HU101MH**

. . . . 1-4000



**HU101FH**

. . . . 1-4000

TIBBE - VALEO

FOR:  
PER:

## FORD AUS

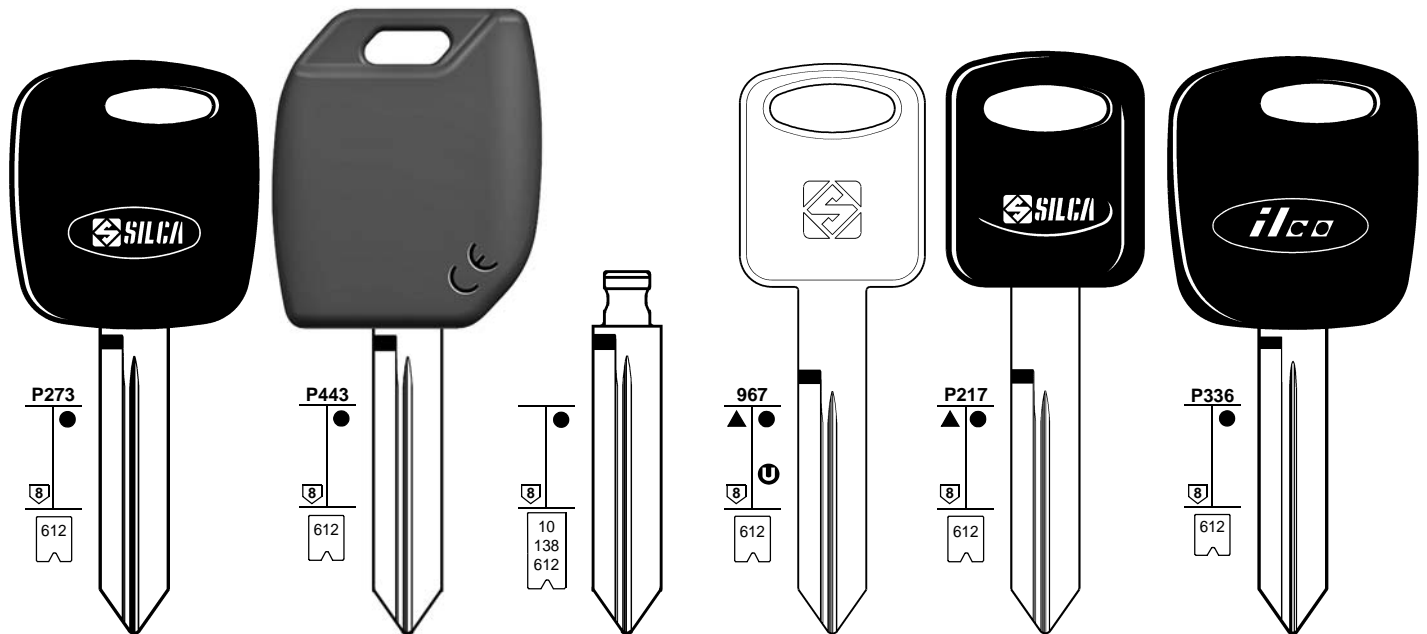

P273



612

P443



612

10  
138  
612

967



612

P217



612

P336



612

. . . . X 1-1706



**FO38RTE**



**FO38RT3**



**FO38RT17**



**FO38RMH**

. . . . X 1-1706



**FO38RFH**

. . . A . . . 101-381.501-579  
. . . B . . . 101-410.501-602  
. . . C . . . 101-404.501-624  
. . . D . . . 101-340.501-602  
. . . E . . . 101-304.501-579  
. . . X 1-1706



**FO40R**

. . . . X 1-1706  
. . . . Y 1-1200



**FO40RBP**

. . . . X 1-1706  
. . . . Y 1-1200



**H86-PT**

. . . . X 1-1706

STRATTEC



FOR:  
PER:

# FORD AUS

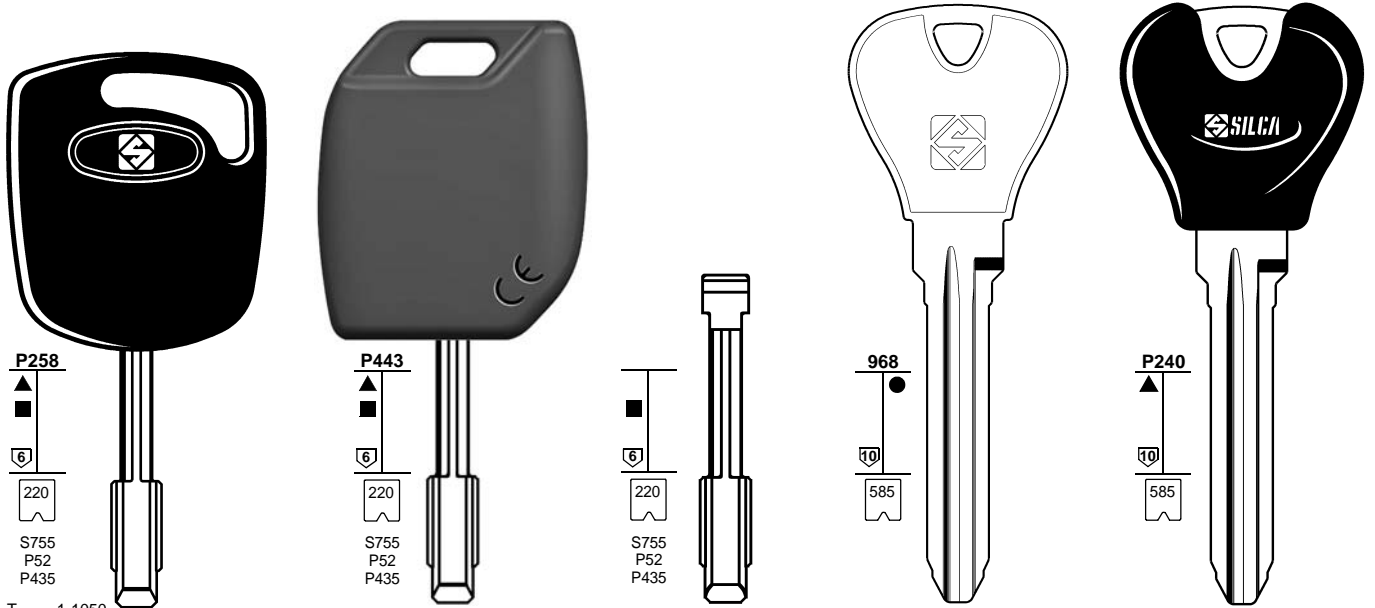

T . . . . 1-1050  
T . . . . 1-2330  
T . . . . 1051-2330  
T . . . . . 1-2-3-4

**TE KEY**  
**FO21TE**  
**FO21T7**

**MH KEY**  
**FO21MH**  
T . . . . 1-1050  
T . . . . 1-2330  
T . . . . 1051-2330  
T . . . . . 1-2-3-4

**FH FLIP**  
**FO21FH**  
T . . . . 1-1050  
T . . . . 1-2330  
T . . . . 1051-2330  
T . . . . . 1-2-3-4

**FO34**  
B . . . . 5001-6200 (NEW)  
B . . . . 1001-2200  
B . . . . 1001-2200 (NEW)  
B . . . . 5001-6200

**FO34AP**  
B . . . . 5001-6200 (NEW)  
B . . . . 1001-2200  
B . . . . 1001-2200 (NEW)  
B . . . . 5001-6200

TIBBE - VALEO

TIBBE - VALEO

FOR:  
PER:

# FORD AUS

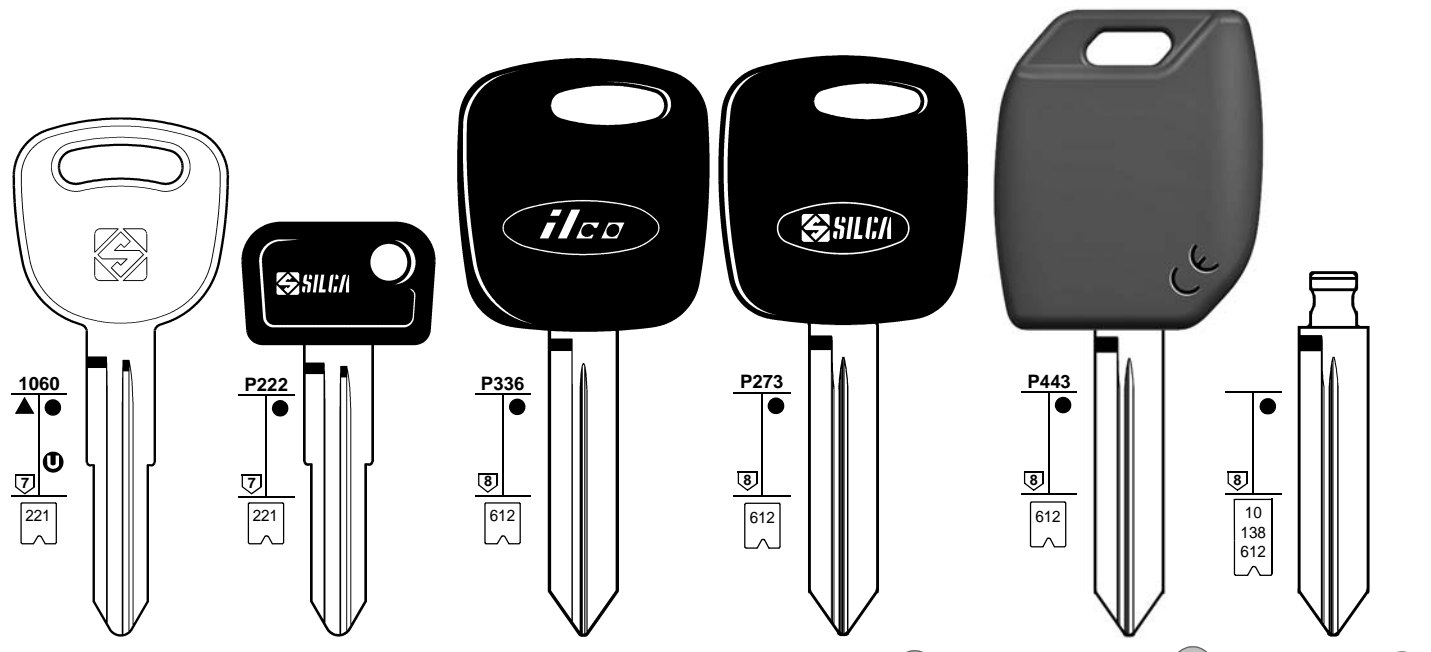

**KIA1R**  
Y . . . .  
7001-8200

**KIA1RP**  
Y . . . .  
7001-8200

**H86-PT**  
. . . . X  
0001-1706

**FO38RTE**  
. . . . X  
0001-1706

**FO38RMH**  
. . . . X  
0001-1706

**FO38RFH**  
. . . . A . . . 101-381.501-579  
. . . . B . . . 101-410.501-602  
. . . . C . . . 101-404.501-624  
. . . . D . . . 101-340.501-602  
. . . . E . . . 101-304.501-579  
. . . . X 1-1706





FOR:  
PER:

# FORD AUS

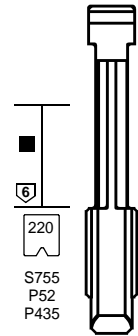
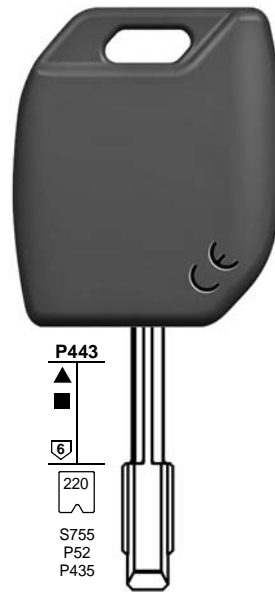
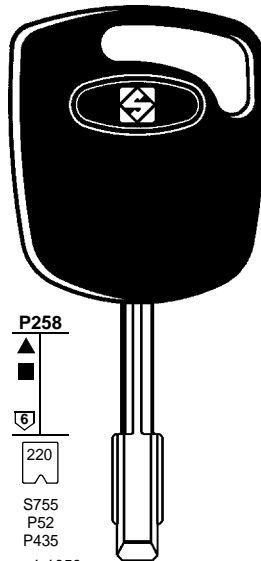
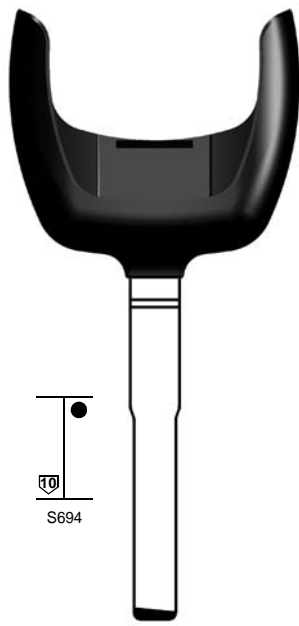
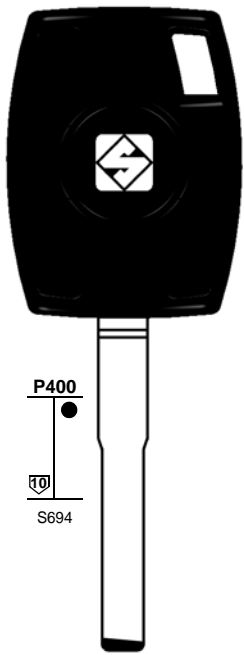

T ..... 1-1050  
T ..... 1-2330  
T ..... 1051-2330  
T ..... 1-2-3-4

**HU101T17**  
..... 1-4000

**HU101AP**  
..... 1-4000

**FO21TE**

**FO21MH**  
T ..... 1-1050  
T ..... 1-2330  
T ..... 1051-2330  
T ..... 1-2-3-4

**FO21FH**  
T ..... 1-1050  
T ..... 1-2330  
T ..... 1051-2330  
T ..... 1-2-3-4

**HU101T20**  
..... 1-4000

**FO21T7**

TIBBE - VALEO

TIBBE - VALEO

FOR:  
PER:

# FORD AUS

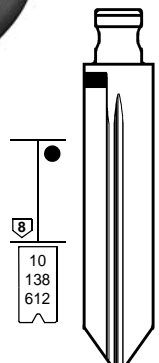
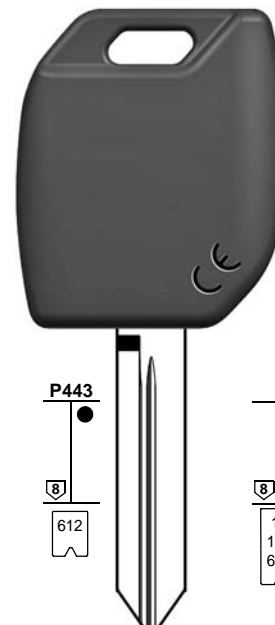
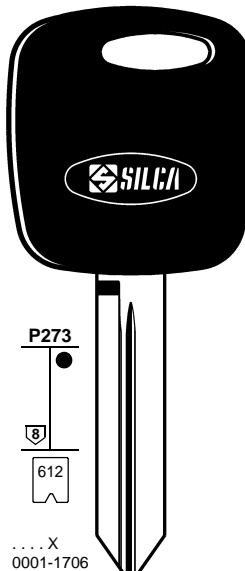
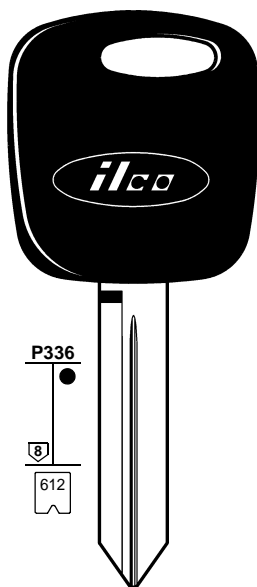
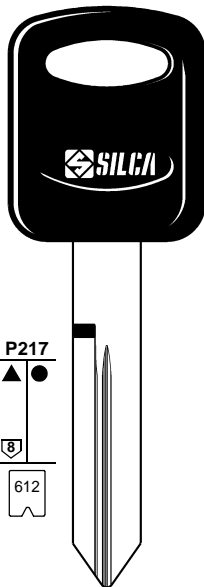
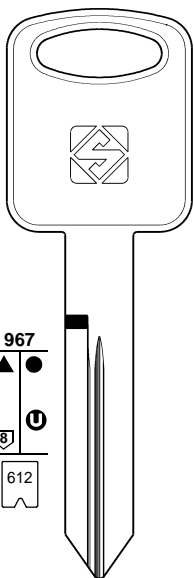

**FO40R**  
..... X 1-1706  
..... Y 1-1200

**FO40RBP**  
..... X 1-1706  
..... Y 1-1200

**H86-PT**  
..... X  
0001-1706

**FO38RTE**

**FO38RT3**

**FO38RT17**

**FO38RMH**  
..... X  
0001-1706

**FO38RFH**  
... A ... 101-381.501-579  
... B ... 101-410.501-602  
... C ... 101-404.501-624  
... D ... 101-340.501-602  
... E ... 101-304.501-579  
... X 1-1706

STRATTEC



FOR:  
PER:

# FORD AUS



**HU101TE**  
..... 1-4000

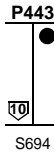

**HU101MH**  
..... 1-4000

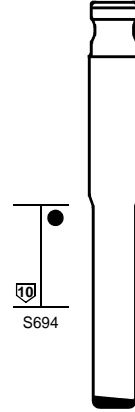

**HU101FH**  
..... 1-4000

FOR:  
PER:

# FORD AUS



**H86-PT**  
..... X  
0001-1706



**FO38RTE**  
..... X  
0001-1706

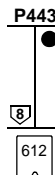

**FO38RMH**  
..... X  
0001-1706

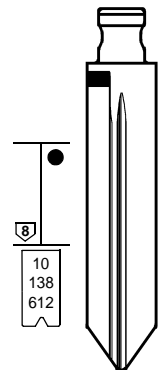

**FO38RFH**  
..... A ... 101-381.501-579  
..... B ... 101-410.501-602  
..... C ... 101-404.501-624  
..... D ... 101-340.501-602  
..... E ... 101-304.501-579  
..... X 1-1706



FOR:  
PER:

## FORD EU

\*

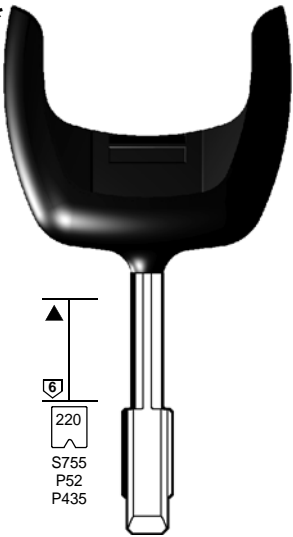

▲  
6  
220  
S755  
P52  
P435

T.... 1-1050  
T.... 1-2330  
T.... 1051-2330  
T..... 1-2-3-4



**FO21AP**

\* Key blank to be applied to the original remote control (the remote control includes the transponder chip)

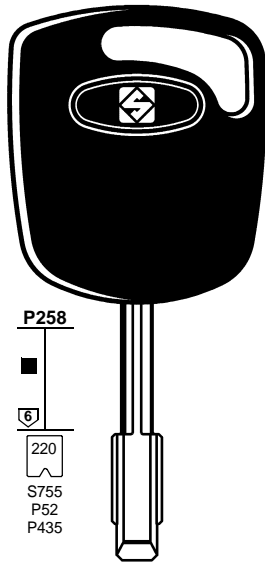

P258  
■  
6  
220  
S755  
P52  
P435

T.... 1-1050  
T.... 1-2330  
T.... 1051-2330  
T..... 1-2-3-4



**FO21TE**



**FO21T17▲**



**FO21T3**



**FO21T7**

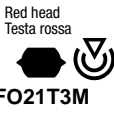

**FO21T3M**

TIBBE - VALEO

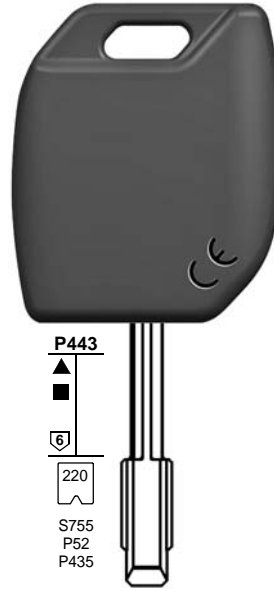

P443  
▲  
■  
6  
220  
S755  
P52  
P435

T.... 1-1050  
T.... 1-2330  
T.... 1051-2330  
T..... 1-2-3-4



**FO21MH**

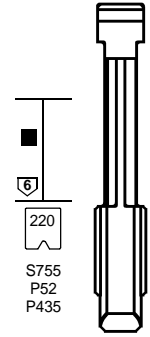

■  
6  
220  
S755  
P52  
P435

T.... 1-1050  
T.... 1-2330  
T.... 1051-2330  
T..... 1-2-3-4



**FO21FH**

TIBBE - VALEO

FOR:  
PER:

## FORD EU

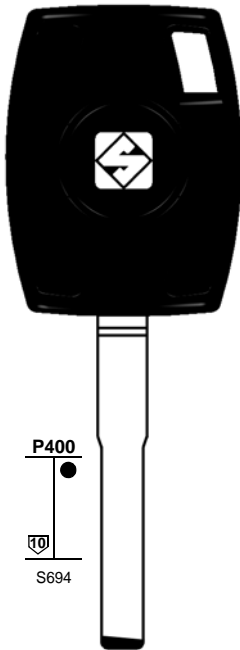

P400  
●  
10  
S694

■  
**HU101T17**  
.... 1-4000

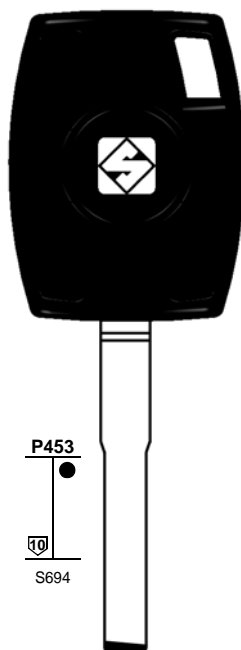

P453  
●  
10  
S694

■  
**HU101TE**  
.... 1-4000



P443  
●  
10  
S694

■  
**HU101MH**  
.... 1-4000

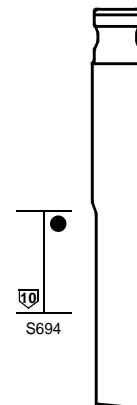

●  
10  
S694

■  
**HU101FH**  
.... 1-4000



FOR:  
PER:

## FORD EU

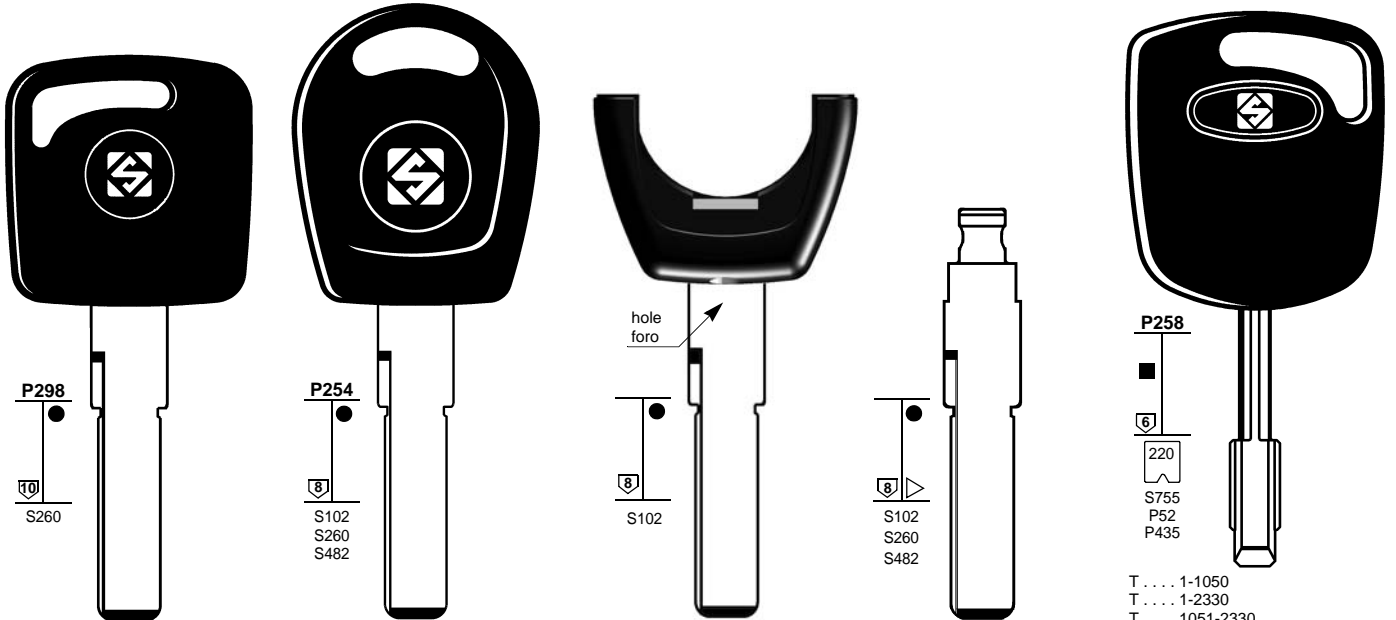

T ..... 1-1050  
T ..... 1-2330  
T ..... 1051-2330  
T ..... 1-2-3-4



**HU66BT1**  
..... 1-2000



**HU66T10**  
1ATS ..... 00001-17850  
..... 1-2000  
..... 1-6000



**HU66DT5**  
..... 1-2000



**HU66FH**  
..... 1-2000  
..... 0001-6000



**FO21TE**



**FO21T3**

Red head  
Testa rossa



**HU66BT28**  
..... 1-2000



**FO21T7**



**FO21T3M**

WITTE

WITTE

TIBBE - VALEO

FOR:  
PER:

## FORD EU

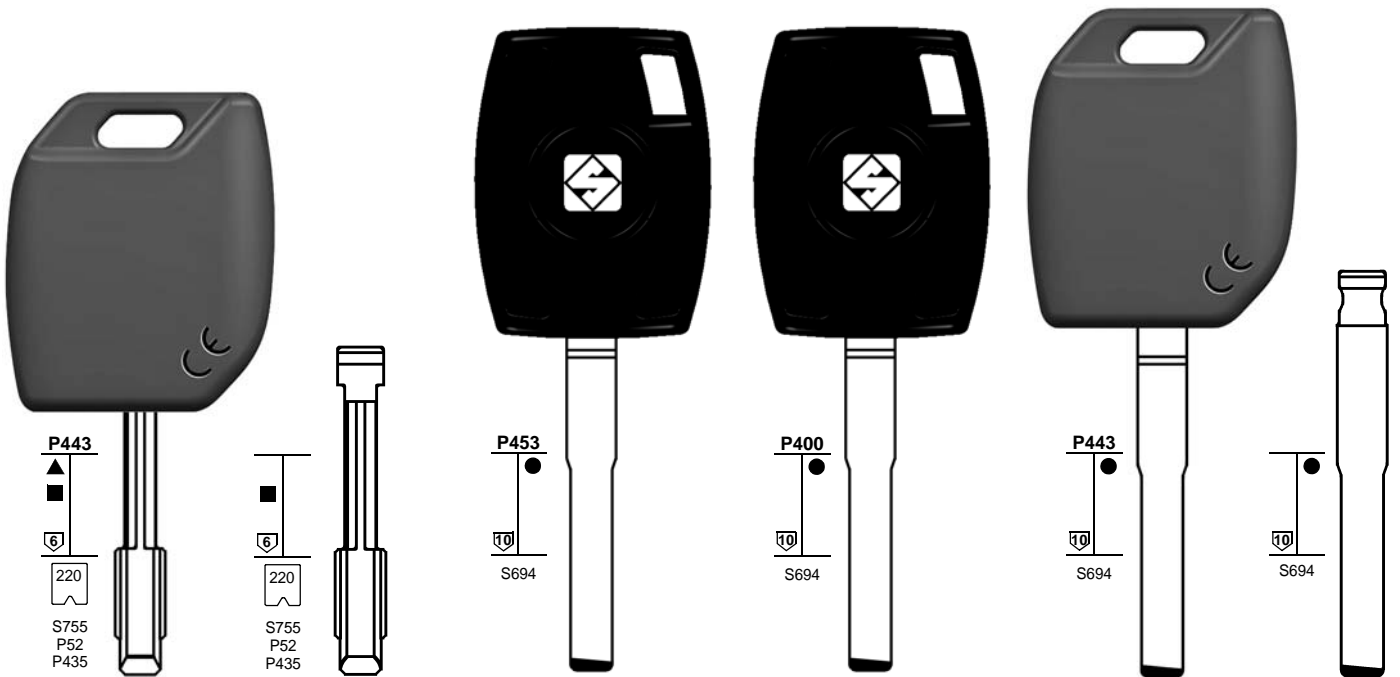

P443  
▲  
■  
6  
220  
S755  
P52  
P435

6  
220  
S755  
P52  
P435

P453  
●  
6  
S694

P400  
●  
6  
S694

P443  
●  
6  
S694

6  
S694



**FO21MH**  
T ..... 1-1050  
T ..... 1-2330  
T ..... 1051-2330  
T ..... 1-2-3-4



**FO21FH**  
T ..... 1-1050  
T ..... 1-2330  
T ..... 1051-2330  
T ..... 1-2-3-4



**HU101TE**  
..... 1-4000



**HU101T17**  
..... 1-4000



**HU101MH**  
..... 1-4000



**HU101FH**  
..... 1-4000

TIBBE - VALEO

STRATTEC

STRATTEC





FOR:  
PER:

## FORD EU

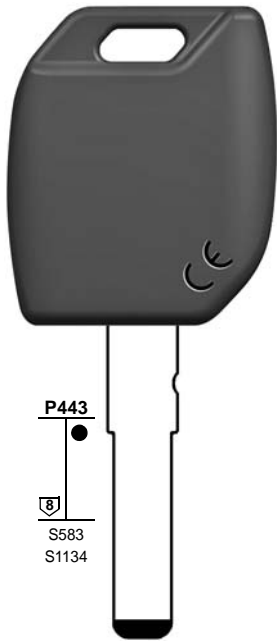

**SIP22MH**  
DE . . . . . 1-11210

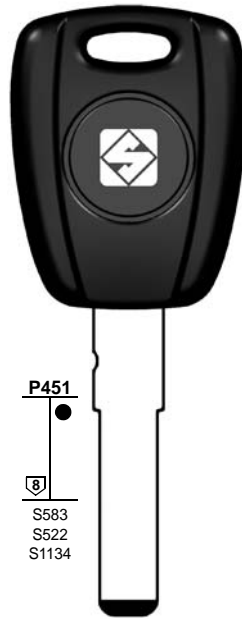

**SIP22TE**  
DE . . . . . 1-11210

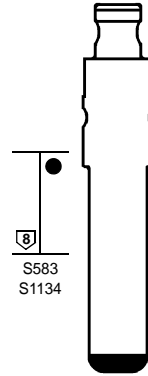

**SIP22FH**  
DE . . . . . 1-11210

GIOBERT - TRW SIPEA

GIOBERT - TRW SIPEA

FOR:  
PER:

## FORD EU

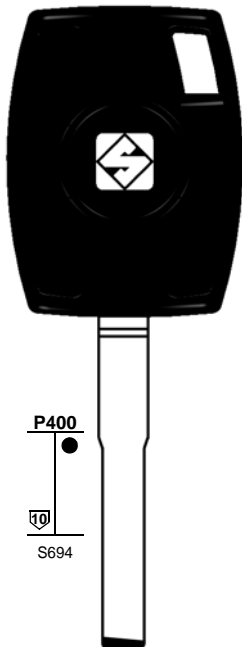

**HU101T17**  
. . . . . 1-4000

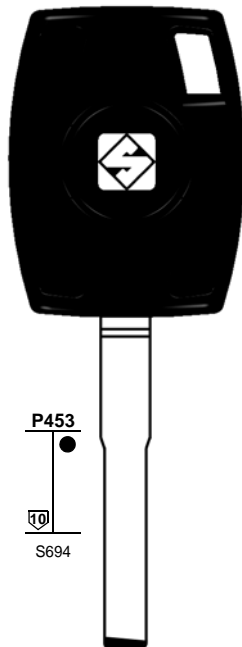

**HU101TE**  
. . . . . 1-4000



**HU101MH**  
. . . . . 1-4000

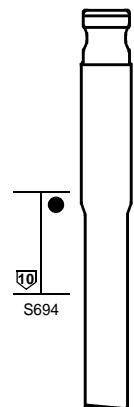

**HU101FH**  
. . . . . 1-4000

STRATTEC

STRATTEC



FOR:  
PER:

## FORD EU

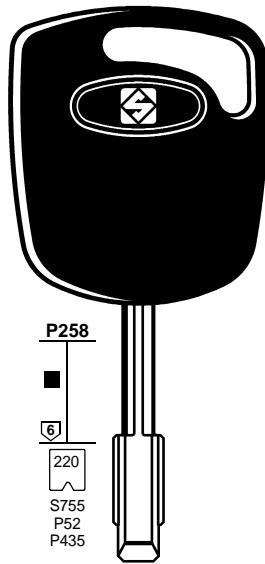
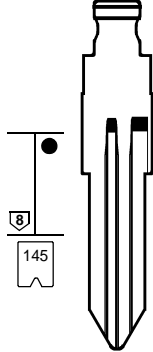
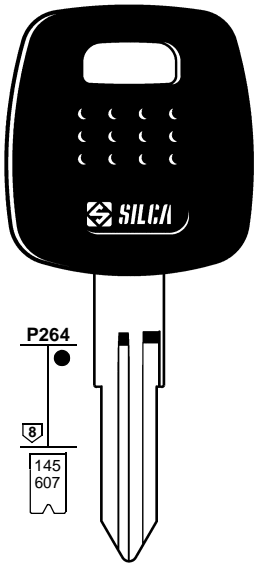

T ..... 1-1050  
T ..... 1-2330  
T ..... 1051-2330  
T ..... 1-2-3-4

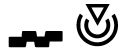
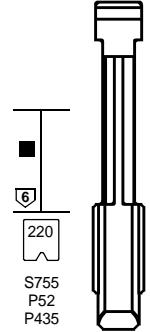
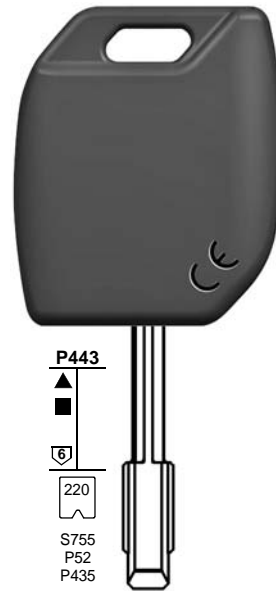

**NSN11T2**

X ..... 1-8000  
..... 1-22185  
..... 30001-37850  
X ..... 8001-9000



**NSN11FH**

X ..... 1-8000  
X ..... 8001-9000



**FO21TE**



**FO21T3**

Red head  
Testa rossa



**FO21T7**



**FO21T3M**



**FO21MH**

T ..... 1-1050  
T ..... 1-2330  
T ..... 1051-2330  
T ..... 1-2-3-4



**FO21FH**

T ..... 1-1050  
T ..... 1-2330  
T ..... 1051-2330  
T ..... 1-2-3-4

VALEO

TIBBE - VALEO

TIBBE - VALEO

FOR:  
PER:

## FORD EU

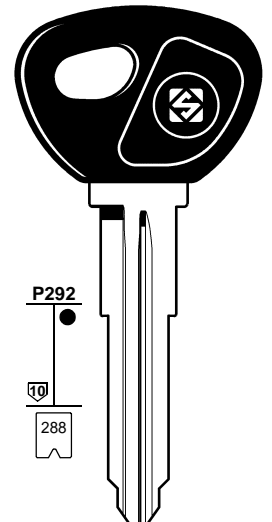
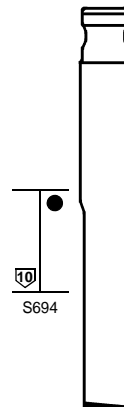
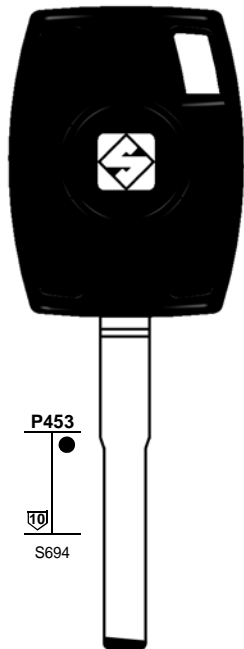
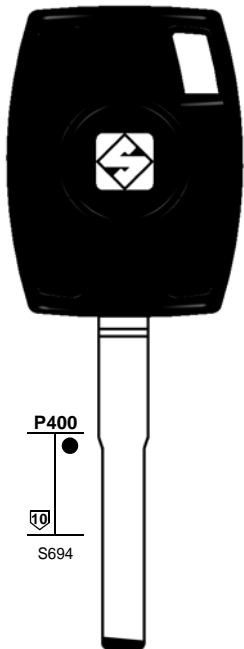

**HU101T17**

..... 1-4000



**HU101TE**

..... 1-4000



**HU101MH**

..... 1-4000



**HU101FH**

..... 1-4000



**MAZ13T5**

.....  
10100-12283



FOR:  
PER:

## FORD SUD AMERICA

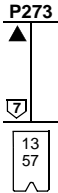

**FO10TE**

AK ..... 1-1000  
TL ..... 1-1000  
TX ..... 1-1859



**FO10T7**

AK ..... 1-1000  
TC ..... 1-1000  
TX ..... 1-1859



**FO10MH**

AK ..... 1-1000  
TC ..... 1-1000  
TX ..... 1-1859

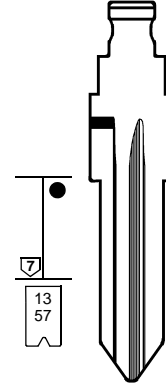

**FO10FH**

AK ..... 1-1000  
TL ..... 1-1000  
TX ..... 1-1859

FOR:  
PER:

## FORD SUD AMERICA

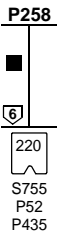
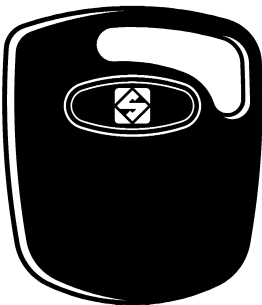

S755  
P52  
P435

T ..... 1-1050  
T ..... 1-2330  
T ..... 1051-2330  
T ..... 1-2-3-4



**FO21TE**



**FO21T3**

Red head  
Testa rossa



**FO21T7**



**FO21T3M**

TIBBE - VALEO

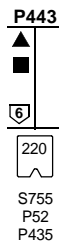

S755  
P52  
P435



**FO21MH**

T ..... 1-1050  
T ..... 1-2330  
T ..... 1051-2330  
T ..... 1-2-3-4

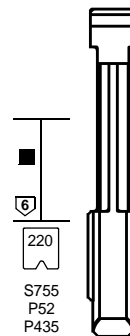

S755  
P52  
P435



**FO21FH**

T ..... 1-1050  
T ..... 1-2330  
T ..... 1051-2330  
T ..... 1-2-3-4



**FO38RT3**

..... X  
0001-1706



**FO38RT17**

..... X  
0001-1706

STRATTEC

TIBBE - VALEO



FOR:  
PER:

# FORD SUD AMERICA

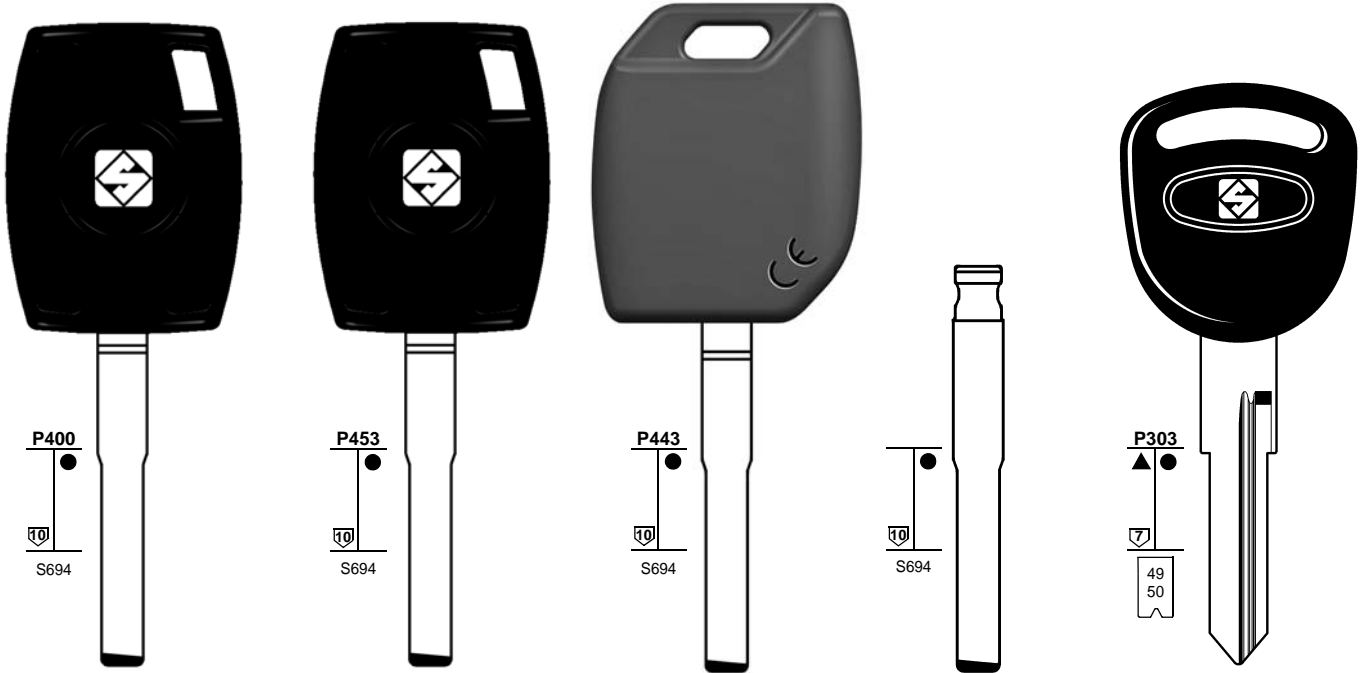

**HU101T17**  
..... 1-4000

**HU101TE**  
..... 1-4000

**HU101MH**  
..... 1-4000

**HU101FH**  
..... 1-4000

**WT7FP**  
HV ..... 1-8154  
HV ..... 1001-9282

HUF

HUF

FOR:  
PER:

# FORD SUD AMERICA

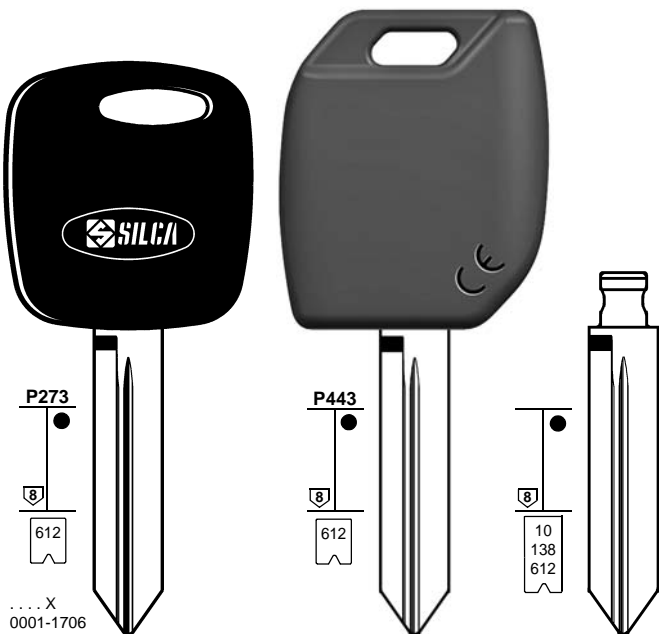

**FO38RTE**  
..... X  
0001-1706

**FO38RMH**  
..... X  
0001-1706

**FO38RFH**  
... A ... 101-381.501-579  
... B ... 101-410.501-602  
... C ... 101-404.501-624  
... D ... 101-340.501-602  
... E ... 101-304.501-579  
... X 1-1706

**FO38RT3**

**FO38RT17**

STRATTEC

# FORD USA

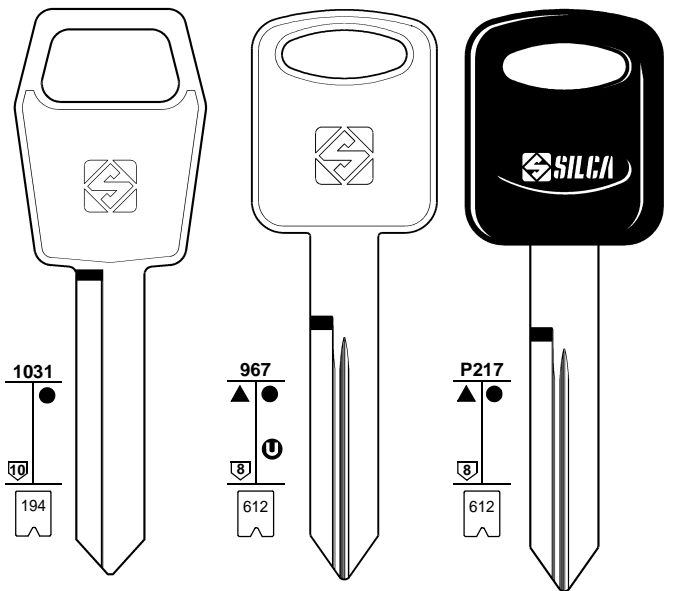

**FO35**  
... A ... 101-381.501-579  
... B ... 101-410.501-602  
... C ... 101-404.501-624  
... D ... 101-340.501-602  
... E ... 101-304.501-579

**FO40R**  
..... X 1-1706  
..... Y 1-1200

**FO40RBP**  
..... X 1-1706  
..... Y 1-1200

STRATTEC

STRATTEC





FOR:  
PER:

# FORD USA

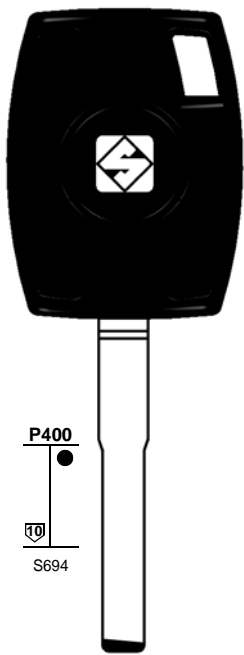

P400  
S694

   
**HU101T20**  
... 1-4000

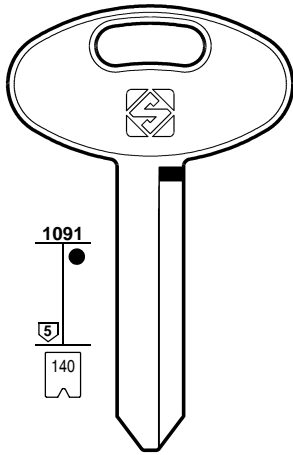

1091  
140

  
**FO37R**  
FB-PF ...  
0000-1863

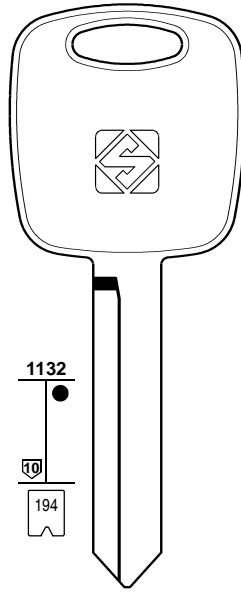

1132  
194

  
**FO39**  
... A ... 101-381.501-579  
... B ... 101-410.501-602  
... C ... 101-404.501-624  
... D ... 101-340.501-602  
... E ... 101-304.501-579

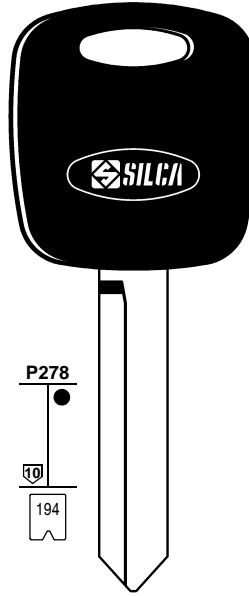

P278  
194

  
**FO39CP**  
... A ... 101-381.501-579  
... B ... 101-410.501-602  
... C ... 101-404.501-624  
... D ... 101-340.501-602  
... E ... 101-304.501-579

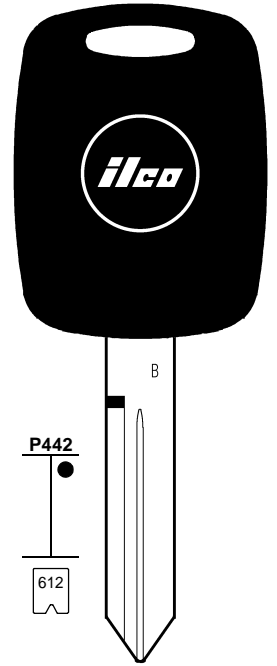

P442  
612

   
**H72-EK3**  
... X  
1-1706

STRATTEC

STRATTEC

FOR:  
PER:

# FORD USA



P273  
194

... A ... 101-381.501-579  
... B ... 101-410.501-602  
... C ... 101-404.501-624  
... D ... 101-340.501-602  
... E ... 101-304.501-579

   
**FO26TE**

   
**FO26T3**

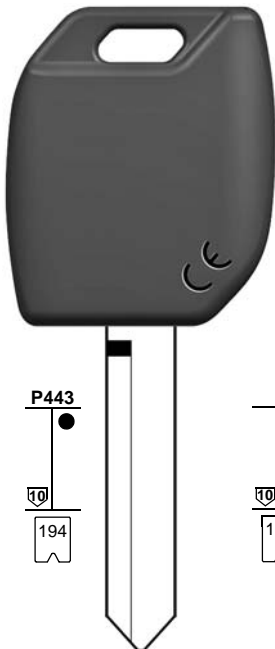

P443  
194

   
**FO26MH**

... A ... 101-381.501-579  
... B ... 101-410.501-602  
... C ... 101-404.501-624  
... D ... 101-340.501-602  
... E ... 101-304.501-579

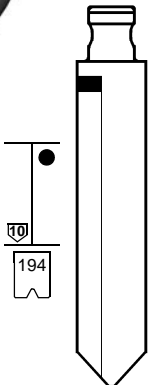

194

   
**FO26FH**

... A ... 101-381.501-579  
... B ... 101-410.501-602  
... C ... 101-404.501-624  
... D ... 101-340.501-602  
... E ... 101-304.501-579

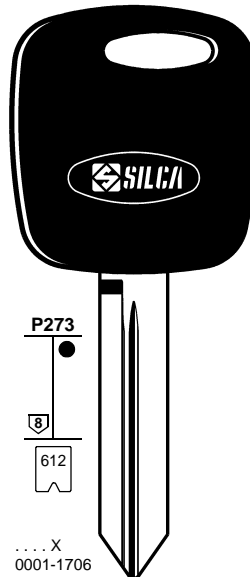

P273  
612

... X  
0001-1706

   
**FO38RTE**

   
**FO38RT3**

   
**FO38RT17**

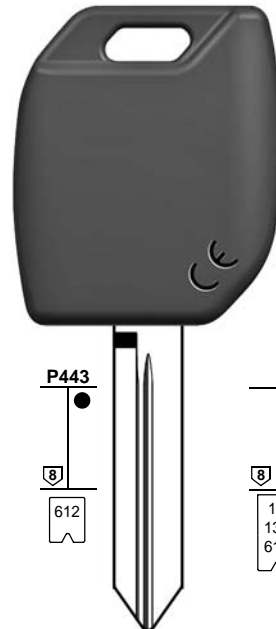

P443  
612

   
**FO38RMH**

... X  
0001-1706

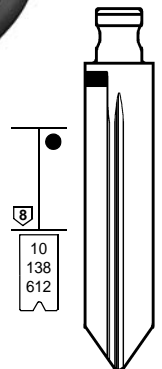

10  
138  
612

   
**FO38RFH**

... A ... 101-381.501-579  
... B ... 101-410.501-602  
... C ... 101-404.501-624  
... D ... 101-340.501-602  
... E ... 101-304.501-579  
... X 1-1706

STRATTEC

STRATTEC

STRATTEC



FOR:  
PER:

# FORD USA

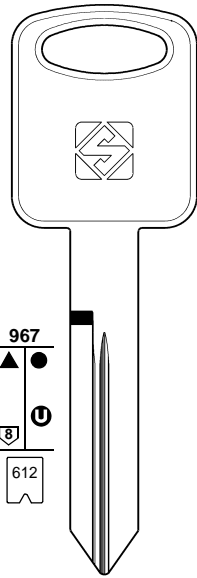

**FO40R**  
.... X 1-1706  
.... Y 1-1200

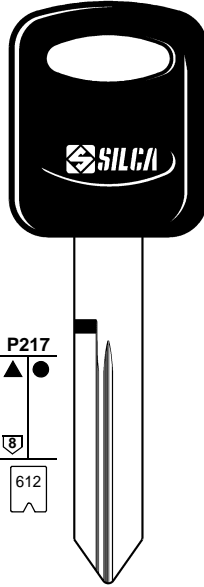

**FO40RBP**  
.... X 1-1706  
.... Y 1-1200

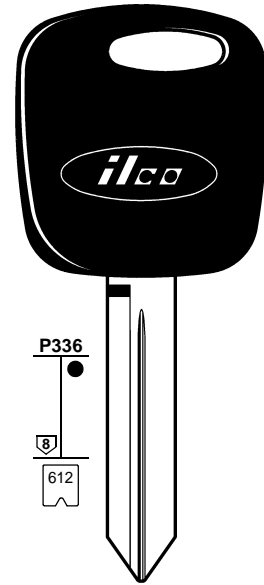

**H86-PT**  
.... X  
0001-1706

STRATTEC

STRATTEC

FOR:  
PER:

# FORD USA

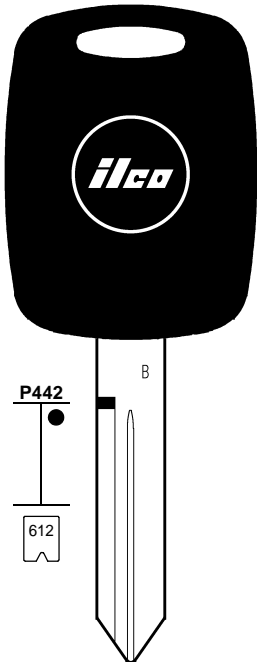

**H72-EK3**  
.... X  
1-1706

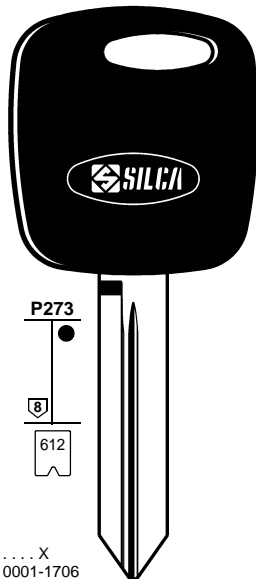

.... X  
0001-1706  
**FO38RTE**  
**FO38RT3**  
**FO38RT17**

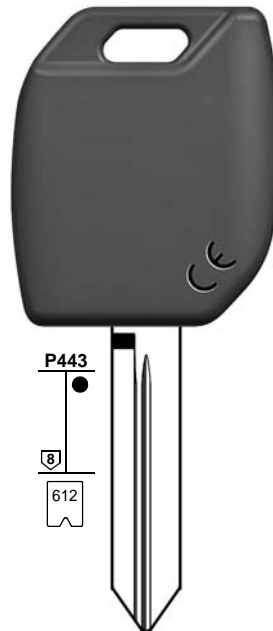

**FO38RMH**  
.... X  
0001-1706

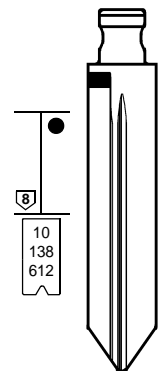

**FO38RFH**  
.... A ... 101-381.501-579  
.... B ... 101-410.501-602  
.... C ... 101-404.501-624  
.... D ... 101-340.501-602  
.... E ... 101-304.501-579  
.... X 1-1706

STRATTEC

STRATTEC

1	2	2a	3	3a	3b	e1+e2		6	42+71	72	43+44a	12	15
						GTI COMPATIBLE		IGNITION					
CAR MAKE MODEL	FROM	TO	SILCA REF.	SILCA REF.	SILCA REF.	COPY	GEN.	TRANSP. TYPE	FAST COPY PLUS RW4 PLUS FAST COPY/RW4	FAST COPY PLUS RW4 PLUS	FAST COPY RW4	STP	
For more info on the uses of car keys, refer to the Silca Electronic Keys Catalogue:													
<b>FORD USA</b>													
ESCAPE	2001	2004	H86-PT					TEX / CR	60				H
ESCAPE	2001	2004	FO38RMH	FO38RTE	FO38RFH	Y	Y	TEX / CR	60	Y	P-BOX		
ESCAPE	2005	2012	FO38RT17					TEX / CR	63				C
ESCAPE	2005	2012	FO38RMH	FO38RTE	FO38RFH	Y	Y	TEX / CR	63	Y	P-BOX		
ESCAPE	2012							TEX / MA	6E				
E-SERIES VAN	2008	2012	FO38RT17					TEX / CR	63				
E-SERIES VAN	2008	2012	FO38RMH	FO38RTE	FO38RFH	Y	Y	TEX / CR	63	Y	P-BOX		
E-SERIES VAN	2008							TEX / MA	6E				C
EXCURSION	2000	2006	FO38RT3					TEXAS	4C				C
EXCURSION	2000	2006	FO38RMH	FO38RTE	FO38RFH	Y	Y	TEXAS	4C	Y	P-BOX		
EXCURSION	2000	2006	H72-EK3					TEXAS	4C	Y	Y		
EXPEDITION	1997	1998	FO38RT3					TEXAS	4C				B
EXPEDITION	1997	2002	FO38RMH	FO38RTE	FO38RFH	Y	Y	TEXAS	4C	Y	P-BOX		
EXPEDITION	1997	2002	H72-EK3					TEXAS	4C	Y	Y		
EXPEDITION	1999	2002	FO38RT3					TEXAS	4C				C
EXPEDITION	2003	2010	FO38RT17					TEX / CR	63				C
EXPEDITION	2003	2010	FO38RMH	FO38RTE	FO38RFH	Y	Y	TEX / CR	63	Y	P-BOX		
EXPEDITION	2011							TEX / MA	6E				
EXPLORER	1996	1997	FO40R										
EXPLORER	1996	1997	FO40RBP										
EXPLORER	1998	2001	FO38RT3					TEXAS	4C				C
EXPLORER	1998	2001	H72-EK3					TEXAS	4C	Y	Y		
EXPLORER	1998	2001	FO38RMH	FO38RTE	FO38RFH	Y	Y	TEXAS	4C	Y	P-BOX		
EXPLORER	2001	2003	FO38RMH	FO38RTE	FO38RFH	Y	Y	TEX / CR	60	Y	P-BOX		
EXPLORER	2001	2003	H86-PT					TEX / CR	60				C
EXPLORER	2004	2010	FO38RT17					TEX / CR	63				C
EXPLORER	2004	2010	FO38RMH	FO38RTE	FO38RFH	Y	Y	TEX / CR	63	Y	P-BOX		
EXPLORER	2010		SMARTKEY					TEX / MA	6E				
EXPLORER	2011							TEX / MA	6E				
EXPLORER SPORT TRAC	1999	2001	FO38RT3					TEXAS	4C				C
EXPLORER SPORT TRAC	1999	2001	FO38RMH	FO38RTE	FO38RFH	Y	Y	TEXAS	4C	Y	P-BOX		
EXPLORER SPORT TRAC	2002	2010	FO38RT17					TEX / CR	63				C
EXPLORER SPORT TRAC	2002	2010	FO38RMH	FO38RTE	FO38RFH	Y	Y	TEX / CR	63	Y	P-BOX		
F-150	1998	2004	FO38RT3					TEXAS	4C				C
F-150	1998	2004	FO38RMH	FO38RTE	FO38RFH	Y	Y	TEXAS	4C	Y	P-BOX		
F-150	1998	2004	H72-EK3					TEXAS	4C	Y	Y		
F-150	2004	2008	FO38RT17					TEX / CR	63				C
F-150	2004	2010	FO38RMH	FO38RTE	FO38RFH	Y	Y	TEX / CR	63	Y	P-BOX		
F-150	2009	2010	FO38RT17					TEX / CR	63				C
F-150	2011							TEX / MA	6E				
F-250	1998	2004	FO38RT3					TEXAS	4C				C
F-250	1998	2004	FO38RMH	FO38RTE	FO38RFH	Y	Y	TEXAS	4C	Y	P-BOX		
F-250	1998	2004	H72-EK3					TEXAS	4C	Y	Y		
F-250	2004	2008	FO38RT17					TEX / CR	63				C
F-250	2004	2010	FO38RMH	FO38RTE	FO38RFH	Y	Y	TEX / CR	63	Y	P-BOX		
F-250	2008	2010	FO38RT17					TEX / CR	63				C

FOR:  
PER:

# FORD USA

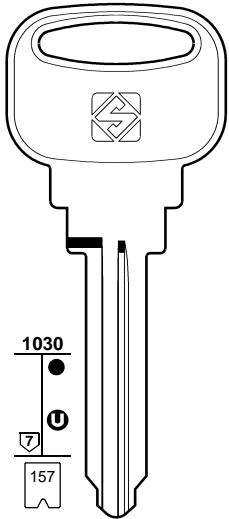

**FO22R**  
FA ...  
6500-7733

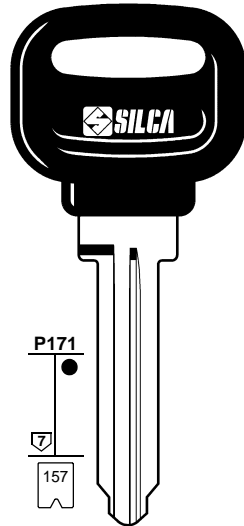

**FO22RP**  
FA ...  
6500-7733

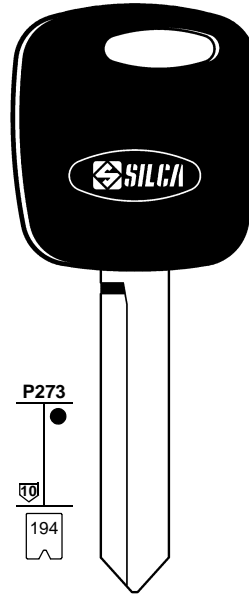

**FO26T3**  
... A ... 101-381.501-579  
... B ... 101-410.501-602  
... C ... 101-404.501-624  
... D ... 101-340.501-602  
... E ... 101-304.501-579

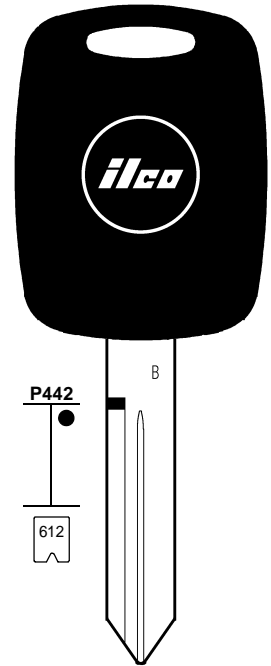

**H72-EK3**  
... X  
1-1706

STRATTEC

FOR:  
PER:

# FORD USA

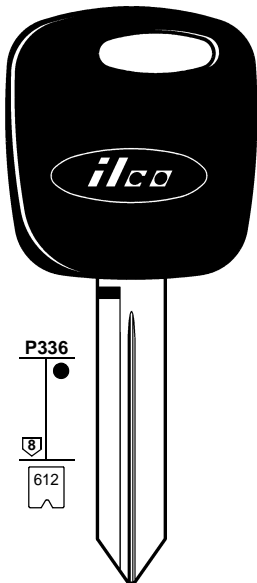

**H86-PT**  
... X  
0001-1706

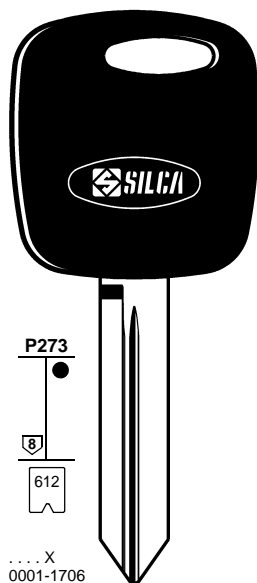

... X  
0001-1706

**FO38RTE** (TE KEY)  
**FO38RT3**  
**FO38RT17**







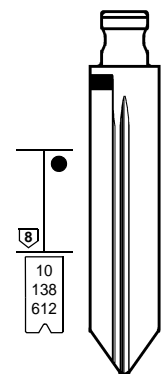











**FO38RMH**  
... X  
0001-1706

STRATTEC



**FO38RFH** (FH FLIP)  
... A ... 101-381.501-579  
... B ... 101-410.501-602  
... C ... 101-404.501-624  
... D ... 101-340.501-602  
... E ... 101-304.501-579  
... X 1-1706

STRATTEC

1	2	2a	3	3a	3b	e1+e2		6	42+71	72	43+44a	12	15
						GTI COMPATIBLE		IGNITION 					
CAR MAKE MODEL	FROM	TO	SILCA REF.	SILCA REF.	SILCA REF.	COPY	GEN.	TRANSP. TYPE	FAST COPY PLUS RW4 PLUS FAST COPY/RW4	FAST COPY PLUS RW4 PLUS	FAST COPY RW4	STP	
													
For more info on the uses of car keys, refer to the Silca Electronic Keys Catalogue: 													
<b>FORD USA</b>													
F-250	2011							TEX / MA	6E				
F-350	1999	2003	FO38RT3					TEXAS	4C				C
F-350	1999	2003	H72-EK3					TEXAS	4C	Y	Y		
F-350	1999	2003	FO38RMH	FO38RTE	FO38RFH	Y	Y	TEXAS	4C	Y		P-BOX	
F-350	2004	2007	FO38RT17					TEX / CR	63				C
F-350	2004	2010	FO38RMH	FO38RTE	FO38RFH	Y	Y	TEX / CR	63	Y		P-BOX	
F-350	2008	2010	FO38RT17					TEX / CR	63				C
F-350	2011							TEX / MA	6E				
FIESTA	2011							TEX / MA	6E				
FIVE HUNDRED	2005	2007	FO38RT17					TEX / CR	63				C
FIVE HUNDRED	2005	2007	FO38RMH	FO38RTE	FO38RFH	Y	Y	TEX / CR	63	Y		P-BOX	
FLEX	2009	2010	FO38RT17					TEX / CR2	6F				
FLEX	2009	2009	FO38RMH	FO38RTE	FO38RFH	Y	Y	TEX / CR3	6A	Y		P-BOX	
FLEX	2009	2010	FO38RMH	FO38RTE	FO38RFH	Y	Y	TEX / CR2	6F	Y		P-BOX	
FLEX	2011							TEX / MA	6E				
FOCUS	2000	2005	H86-PT					TEX / CR	60				C
FOCUS	2005	2007	FO38RMH	FO38RTE	FO38RFH	Y	Y	TEX / CR	63	Y		P-BOX	
FOCUS	2006	2010	FO38RT17					TEX / CR	63				C
FOCUS	2011	2011						TEX / MA	6E				
FOCUS	2012							TEX / MA	6E				
FREESTAR	2004	2007	FO38RT17					TEX / CR	63				C
FREESTAR	2004	2007	FO38RMH	FO38RTE	FO38RFH	Y	Y	TEX / CR	63	Y		P-BOX	
FREESTYLE	2005	2007	FO38RT17					TEX / CR2	6F				C
FREESTYLE	2005	2007	FO38RMH	FO38RTE	FO38RFH	Y	Y	TEX / CR2	6F	Y		P-BOX	
FREESTYLE	2005	2007	FO38RMH	FO38RTE	FO38RFH	Y	Y	TEX / CR3	6A	Y		P-BOX	
FUSION	2006	2011	FO38RT17					TEX / CR2	6F				
FUSION	2006	2011	FO38RMH	FO38RTE	FO38RFH	Y	Y	TEX / CR2	6F	Y		P-BOX	
FUSION	2006	2009	FO38RMH	FO38RTE	FO38RFH	Y	Y	TEX / CR3	6A	Y		P-BOX	
FUSION	2011							TEX / MA	6E				
GT	2005	2006	FO38RT3					TEXAS	4C				C
LTD	1998	2003	FO38RT3					TEXAS	4C				C
MERKUR	1987	1990	FO22RP										
MERKUR	1987	1990	FO22R										
MUSTANG	1997	1998	FO26T3					TEXAS	4C				B
MUSTANG	1998	2004	FO38RT3					TEXAS	4C				C
MUSTANG	1998	2004	FO38RMH	FO38RTE	FO38RFH	Y	Y	TEXAS	4C	Y		P-BOX	
MUSTANG	1998	2004	H72-EK3					TEXAS	4C	Y	Y		
MUSTANG	2005	2012	FO38RMH	FO38RTE	FO38RFH	Y	Y	TEX / CR	63	Y		P-BOX	
MUSTANG	2011							TEX / MA	6E				
MUSTANG COBRA	1996	1997	FO38RT3					TEXAS	4C				B
MUSTANG COBRA	1996	1997	H72-EK3					TEXAS	4C	Y	Y		
MUSTANG COBRA	1996	1997	FO38RMH	FO38RTE	FO38RFH	Y	Y	TEXAS	4C	Y		P-BOX	
MUSTANG GT	1996	1997	FO38RT3					TEXAS	4C				B
MUSTANG GT	1996	1997	FO38RMH	FO38RTE	FO38RFH	Y	Y	TEXAS	4C	Y		P-BOX	
MUSTANG GT	1996	1997	H72-EK3					TEXAS	4C	Y	Y		

FOR:  
PER:

# FORD USA

 <b>1030</b>  <b>P171</b>  <b>967</b>  <b>P217</b>  <b>P442</b>  <b>1132</b>	 <b>FO22R</b> FA . . . . 6500-7733	 <b>FO22RP</b> FA . . . . 6500-7733	 <b>FO40R</b> . . . . X 1-1706 . . . . Y 1-1200	 <b>FO40RBP</b> . . . . X 1-1706 . . . . Y 1-1200	 <b>H72-EK3</b> . . . . X 1-1706	 <b>FO39</b> . . . A . . . 101-381.501-579 . . . B . . . 101-410.501-602 . . . C . . . 101-404.501-624 . . . D . . . 101-340.501-602 . . . E . . . 101-304.501-579
---	---	--	--	--	---	--

STRATTEC

STRATTEC

FOR:  
PER:

# FORD USA

 <b>P278</b>  <b>968</b>  <b>P218</b>  <b>P273</b>  <b>P443</b>	 <b>FO39CP</b> . . . A . . . 101-381.501-579 . . . B . . . 101-410.501-602 . . . C . . . 101-404.501-624 . . . D . . . 101-340.501-602 . . . E . . . 101-304.501-579	 <b>FO32R</b> . . . . . 10100-12283	 <b>FO32RAP</b> . . . . . 10100-12283	 <b>FO38RTE</b> . . . . X 0001-1706	 <b>FO38RMH</b> . . . . X 0001-1706	 <b>FO38RFH</b> . . . A . . . 101-381.501-579 . . . B . . . 101-410.501-602 . . . C . . . 101-404.501-624 . . . D . . . 101-340.501-602 . . . E . . . 101-304.501-579 . . . X 1-1706
--	--	---	---	--	--	---

STRATTEC





FOR:  
PER:

# FORD USA

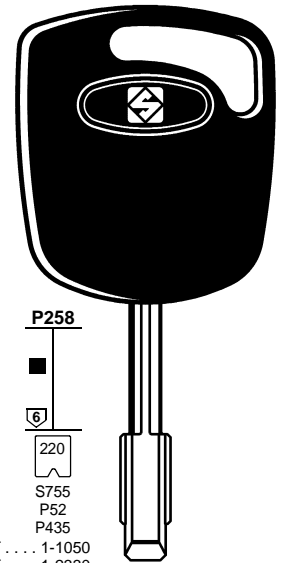
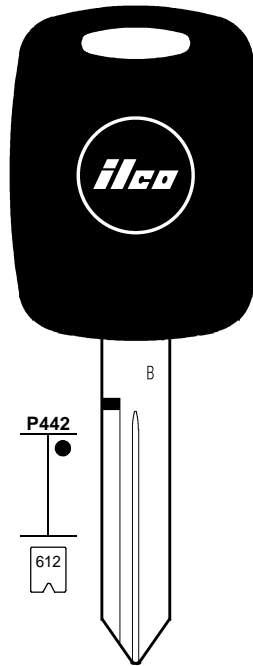
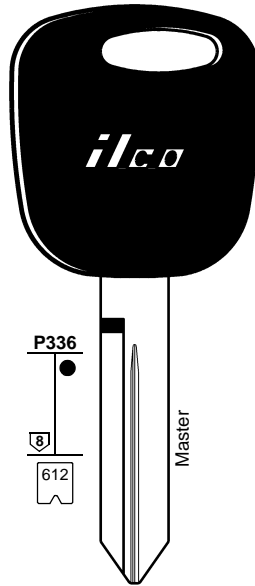
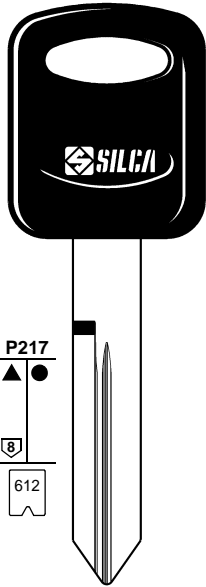
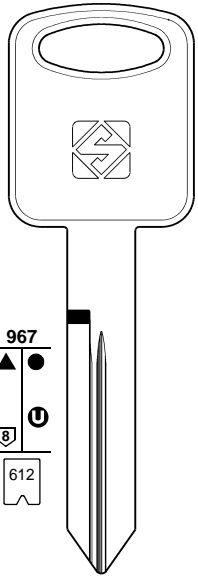

T... 1-1050  
T... 1-2330  
T... 1051-2330  
T... 1-2-3-4



**FO40R**  
.... X 1-1706  
.... Y 1-1200



**FO40RBP**  
.... X 1-1706  
.... Y 1-1200



**H74-PT**  
.... X  
0001-1706



**H72-EK3**  
.... X  
1-1706



**FO21TE**



**FO21T17**

STRATTEC

STRATTEC

TIBBE - VALEO

FOR:  
PER:

# FORD USA

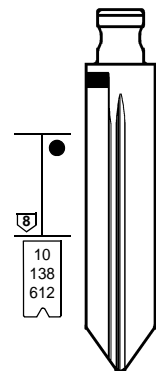
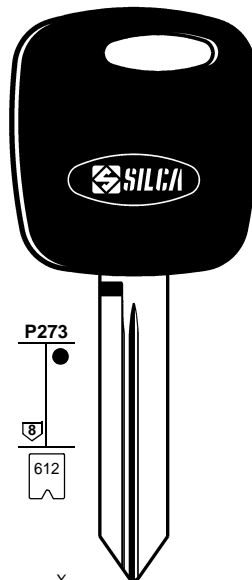
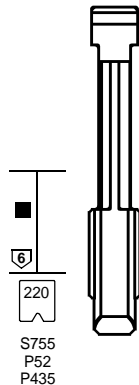

P443  
▲  
■  
6  
220  
S755  
P52  
P435

220  
S755  
P52  
P435

P273  
●  
6  
612  
.... X  
0001-1706

P443  
●  
6  
612

10  
138  
612



**FO21MH**  
T... 1-1050  
T... 1-2330  
T... 1051-2330  
T... 1-2-3-4



**FO21FH**  
T... 1-1050  
T... 1-2330  
T... 1051-2330  
T... 1-2-3-4



**FO38RTE**



**FO38RT3**



**FO38RT17**



**FO38RMH**  
.... X  
0001-1706



**FO38RFH**  
... A ... 101-381.501-579  
... B ... 101-410.501-602  
... C ... 101-404.501-624  
... D ... 101-340.501-602  
... E ... 101-304.501-579  
... X 1-1706

TIBBE - VALEO

STRATTEC

STRATTEC



FOR:  
PER:

# GMC (GM)

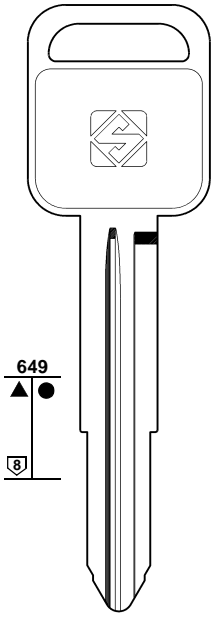

**GM19**

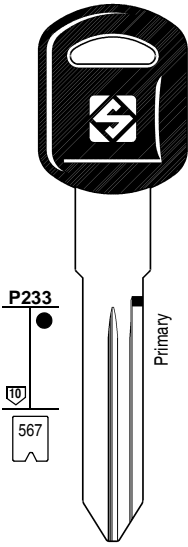

**GM39EP**  
..... AA00-7T51  
..... S000A-S711K

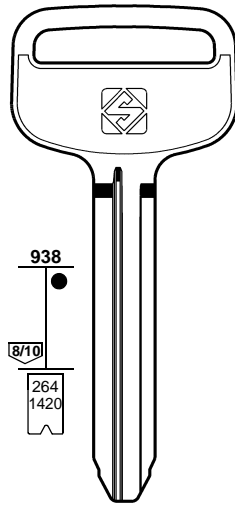

**TOY43R**  
.....  
10001-15000  
50000-59999  
60000-69999  
70000-75928

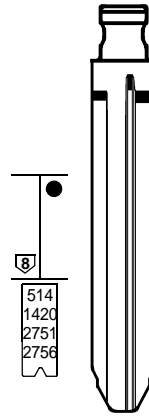

**TOY43RFH**  
..... 1001-15000  
..... 70000-75928

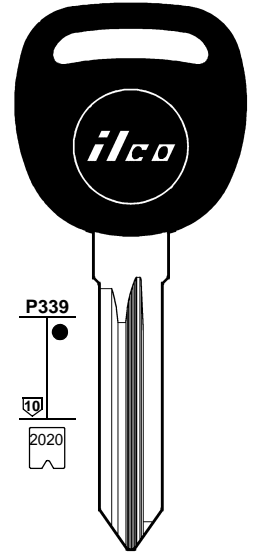

**B111-PT**  
G . . . . 0-3631

BRIGGS & STRATTON

BRIGGS & STRATTON

FOR:  
PER:

# GMC (GM)

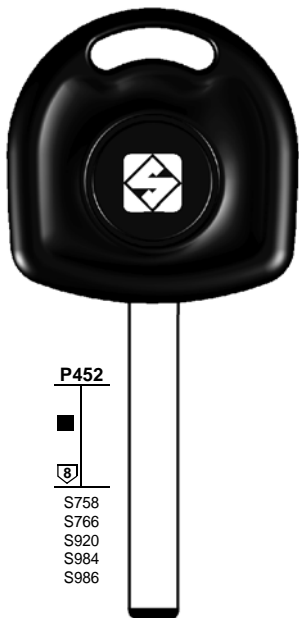

**TE KEY**  
**HU100TE**  
Z . . . . 1-2000  
Z . . . . 2001-4000  
Z . . . . 4001-6000



**MH KEY**  
**HU100MH**  
Z . . . . 1-2000  
Z . . . . 2001-4000  
Z . . . . 4001-6000

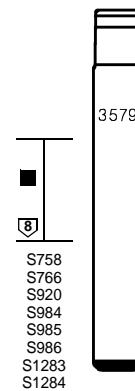

**FH FLIP**  
**HU100FH**  
Z . . . . 1-2000  
Z . . . . 2001-4000  
Z . . . . 4001-6000  
..... 0001-3679

HUF - VALEO

HUF - VALEO



FOR:  
PER:

# HOLDEN

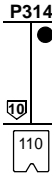

**HU46T12**  
S ..... 1-5200  
S ..... 5298-6300

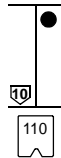
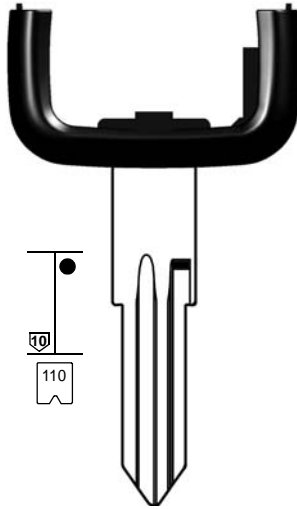

**HU46AT9**  
S ..... 1-5200  
S ..... 5298-6300

**HU46AT12**  
S ..... 1-5200  
S ..... 5298-6300

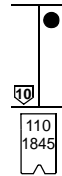
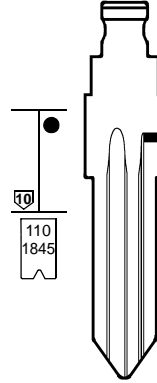

**HU46FH**  
S ..... 5298-6300  
S ..... 1-5200

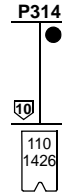

**YM28T2**  
D ..... 1-5200  
S ..... 1-5200  
S ..... 5298-6300  
..... 1002-3997  
..... 4000-5874

**HU46T2**  
S ..... 1-5200  
S ..... 5298-6300

**HU46T9**  
S ..... 1-5200  
S ..... 5298-6300

WITTE

HUF - VALEO

WITTE

HUF - VALEO

FOR:  
PER:

# HOLDEN

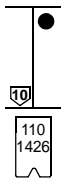
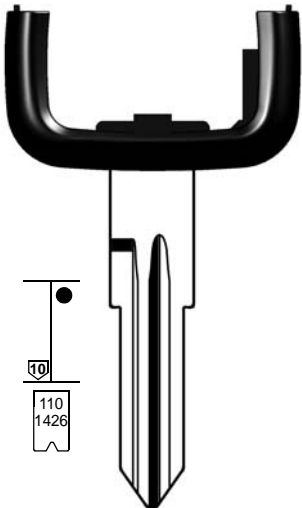

**YM28AT9**  
D ..... 1-5200  
S ..... 1-5200  
S ..... 5298-6300  
..... 1002-3997  
..... 4000-5874

HUF - VALEO

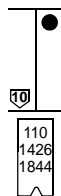
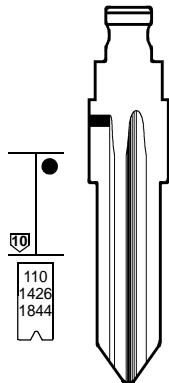

**YM28AT12**  
D ..... 1-5200  
S ..... 1-5200  
S ..... 5298-6300  
..... 1002-3997  
..... 4000-5874

HUF - VALEO

**YM28FH**  
D ..... 1-5200  
..... 1002-3997  
..... 4000-5874  
D ..... 1-5200

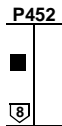
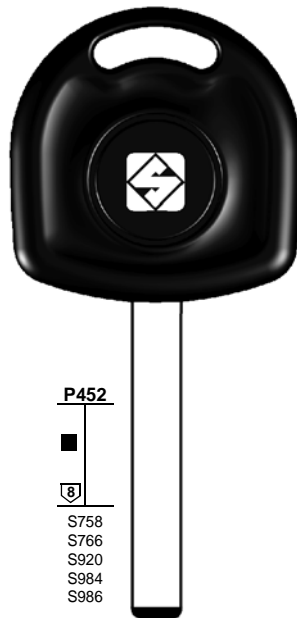

S758  
S766  
S920  
S984  
S986

**HU100TE**  
Z ..... 1-2000  
Z ..... 2001-4000  
Z ..... 4001-6000

HUF - VALEO

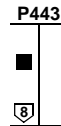

S758  
S766  
S920  
S984  
S985  
S986

**HU100MH**  
Z ..... 1-2000  
Z ..... 2001-4000  
Z ..... 4001-6000

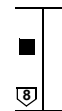

S758  
S766  
S920  
S984  
S985  
S986  
S1283  
S1284

**HU100FH**  
Z ..... 1-2000  
Z ..... 2001-4000  
Z ..... 4001-6000  
..... 0001-3679

HUF - VALEO



FOR:  
PER:

# HOLDEN

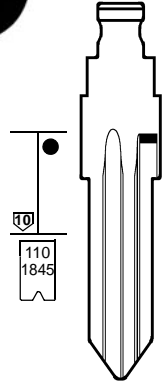
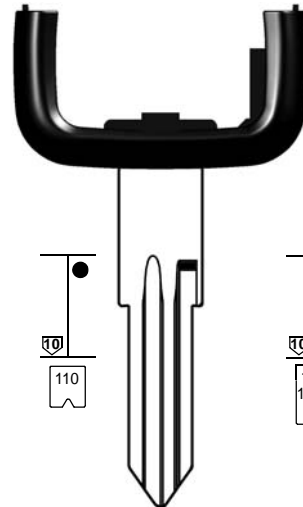
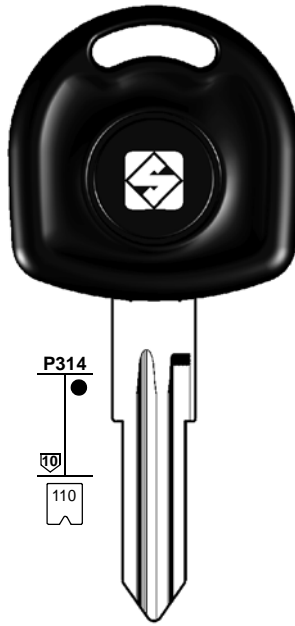
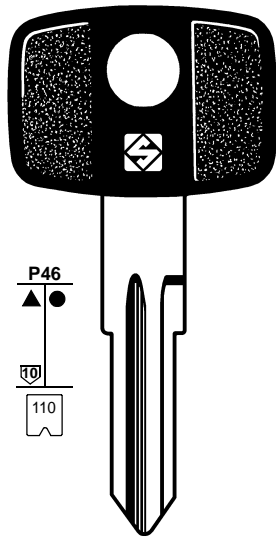
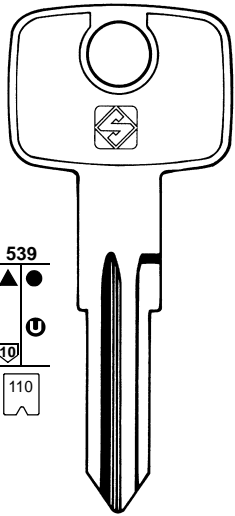

**HU46**

S . . . . 1-5200  
S . . . . 5298-6300



**HU46P**

S . . . . 1-5200  
S . . . . 5298-6300



**HU46T2**

S . . . . 1-5200  
S . . . . 5298-6300



**HU46T9**

S . . . . 1-5200  
S . . . . 5298-6300



**HU46AT9**

S . . . . 1-5200  
S . . . . 5298-6300



**HU46FH**

S . . . . 5298-6300  
S . . . . 1-5200

WITTE

HUF - VALEO

WITTE

FOR:  
PER:

# HOLDEN

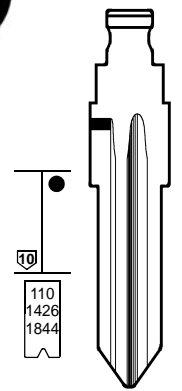
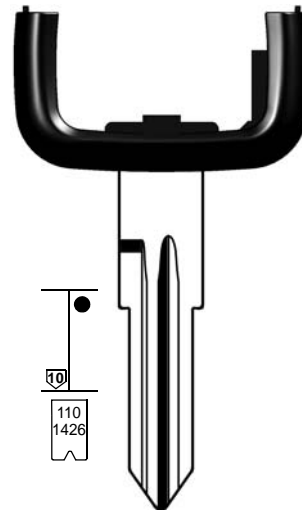
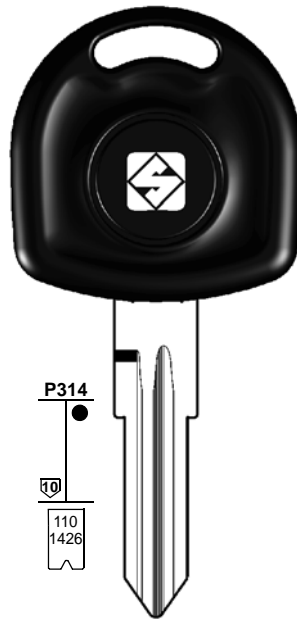
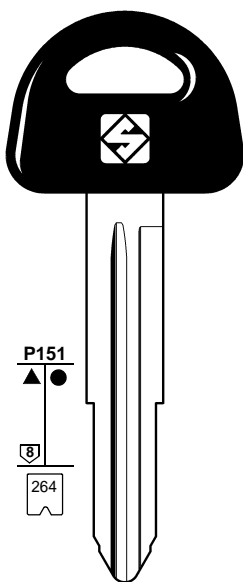
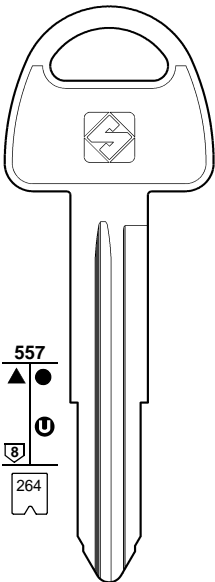

**SZ12**

U . . . . 1-2000



**SZ12P**

U . . . . 1-2000



**YM28T2**

D . . . . 1-5200  
S . . . . 1-5200  
S . . . . 5298-6300  
. . . . 1002-3997  
. . . . 4000-5874



**YM28AT9**

D . . . . 1-5200  
S . . . . 1-5200  
S . . . . 5298-6300  
. . . . 1002-3997  
. . . . 4000-5874



**YM28FH**

D . . . . 1-5200  
. . . . 1002-3997  
. . . . 4000-5874  
D . . . . 1-5200

VALEO - YMOS

VALEO - YMOS





FOR:  
PER:

# HOLDEN

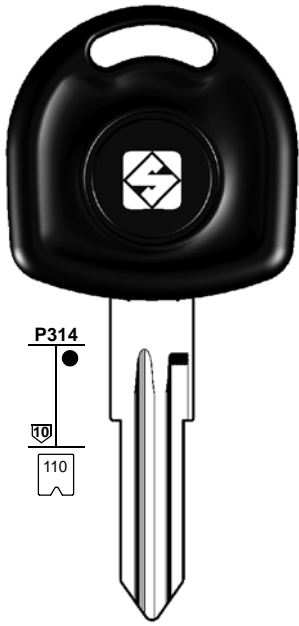

P314  
110



**HU46T2**

S.... 1-5200  
S.... 5298-6300

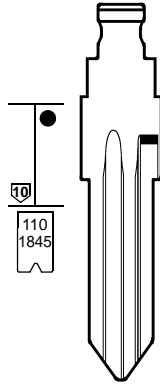

110  
1845



**HU46FH**

S.... 5298-6300  
S.... 1-5200

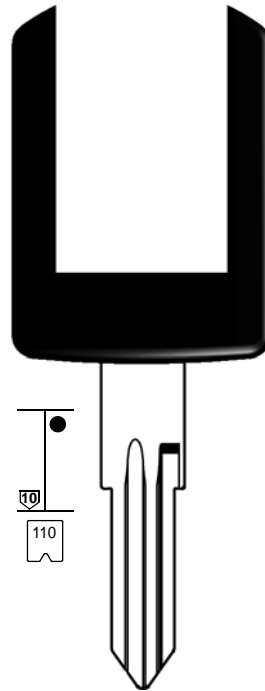

110



**HU46BT12**

S.... 1-5200  
S.... 5298-6300

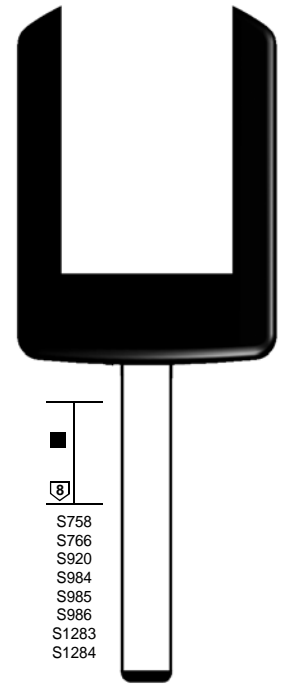

8  
S758  
S766  
S920  
S984  
S985  
S986  
S1283  
S1284



**HU100BT12**

Z.... 1-2000  
Z.... 2001-4000  
Z.... 4001-6000  
.... 0001-3679

HUF

HUF

FOR:  
PER:

# HOLDEN

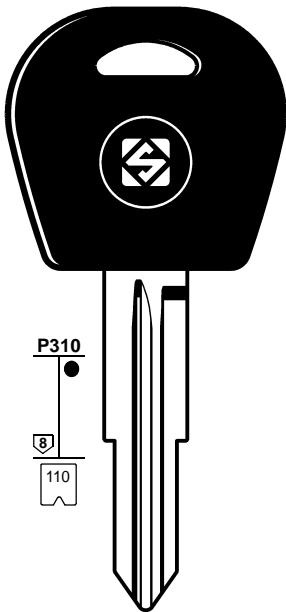

P310  
110



**DWO4RT6**

J.... 1-1200

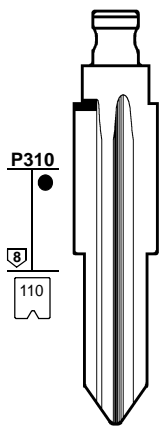

P310  
110



**DWO4RFH**

J.... 1-1200  
T.... 1-1200  
M.... 1-1200

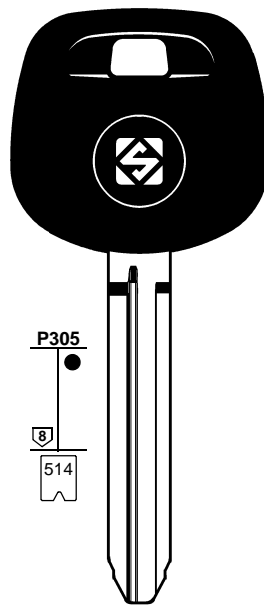

P305  
514



**TOY43RATE**

.....  
10001-15000  
50000-59999  
60000-69999



P443  
8/10  
514  
1420  
1552  
2751  
2756  
S14



**TOY43RMH**

.....  
10001-15000  
70000-75928

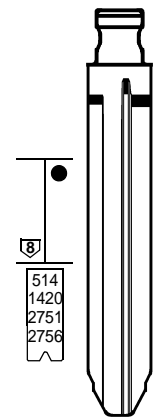

514  
1420  
2751  
2756



**TOY43RFH**

..... 1001-15000  
..... 70000-75928



FOR:  
PER:

# HOLDEN

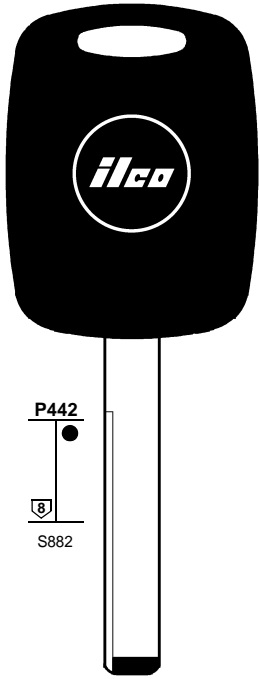

  
**EK3P-GM45**  
60000-62113

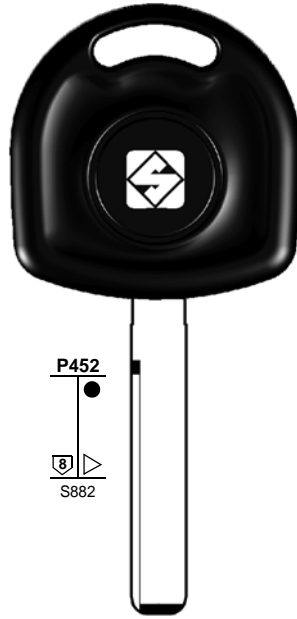

  
**GM45TE**  
60000-62113

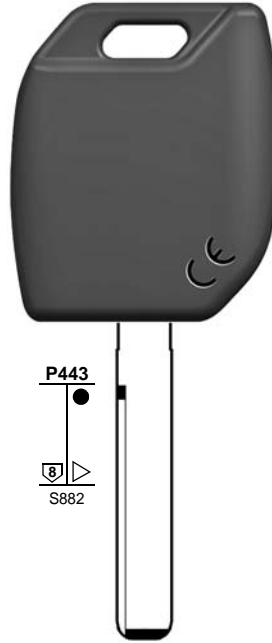

  
**GM45MH**  
60000-62113

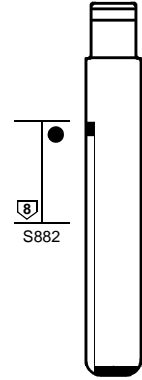

  
**GM45FH**  
60000-62113

BRIGGS & STRATTON

BRIGGS & STRATTON

FOR:  
PER:

# HOLDEN

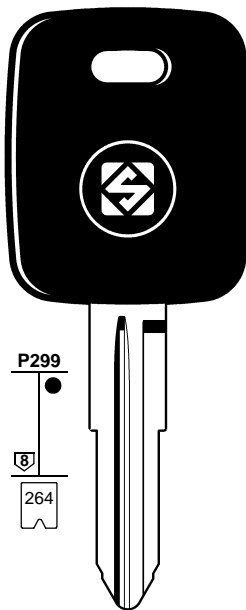

  
**GM15T5**  
N... 5001-7000

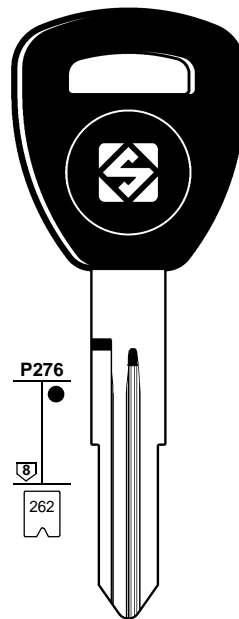

  
**HON58RT6**  
... 5001-8442

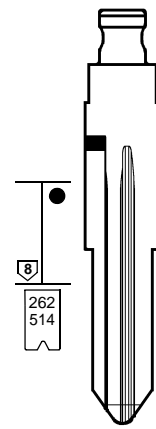



  
**HON58RFH**  
... 5001-8442  
... 10001-15000



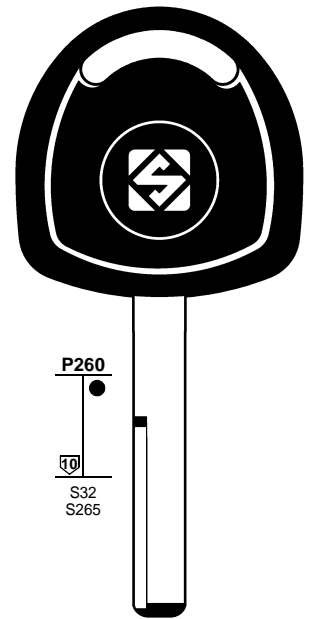
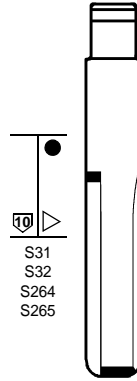
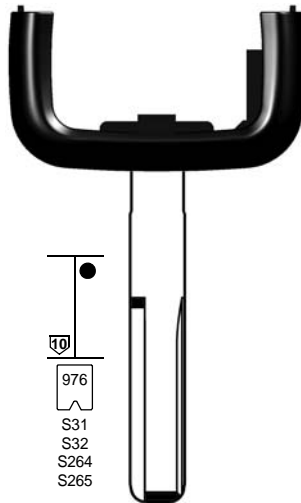
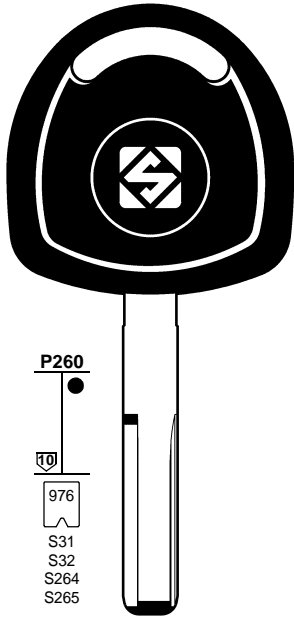

FOR:  
PER:

# HOLDEN



  
**HU43T2**  
H . . . . 1-3000  
WH . . . . 1-3000  
WY . . . . 1-3000  
Y . . . . 1-3000

  
**HU43T9**  
H . . . . 1-3000  
WH . . . . 1-3000  
WY . . . . 1-3000  
Y . . . . 1-3000

  
**HU43AT9**  
H . . . . 1-3000  
WH . . . . 1-3000  
WY . . . . 1-3000  
Y . . . . 1-3000

 **FH FLIP**  
**HU43FH**  
H . . . . 1-3000  
WH . . . . 1-3000  
WY . . . . 1-3000  
Y . . . . 1-3000

  
**YM27T2**  
Y . . . .  
WY . . . .  
1-3000

HUF - WITTE

HUF - WITTE

FOR:  
PER:

# HOLDEN

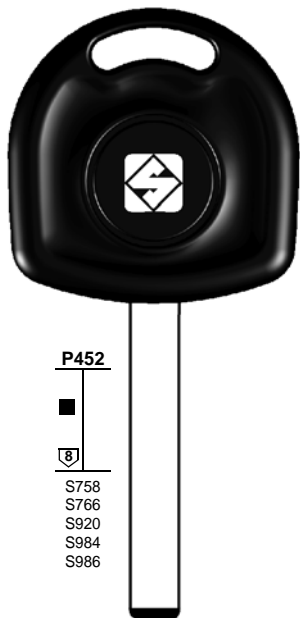

  
**HU100TE**  
Z . . . . 1-2000  
Z . . . . 2001-4000  
Z . . . . 4001-6000

  
**HU100MH**  
Z . . . . 1-2000  
Z . . . . 2001-4000  
Z . . . . 4001-6000

  
**HU100FH**  
Z . . . . 1-2000  
Z . . . . 2001-4000  
Z . . . . 4001-6000  
. . . . 0001-3679

HUF - VALEO

HUF - VALEO



FOR:  
PER:

# HONDA

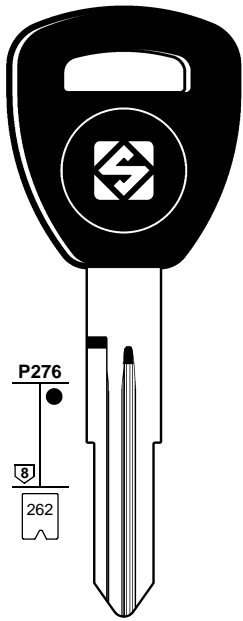

**HON58RT5**  
..... 5001-8442

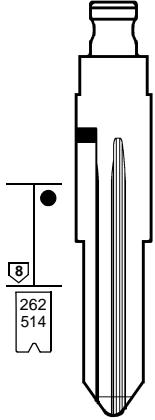

**HON58RFH**  
..... 5001-8442  
..... 10001-15000

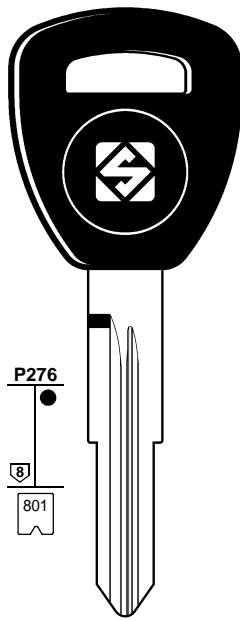

**HON65RT6**  
R..... 1-1706

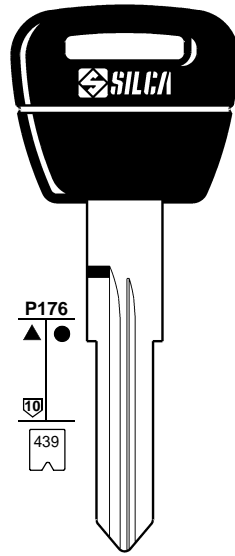

**NE77RDP**  
R.....  
6001-8000

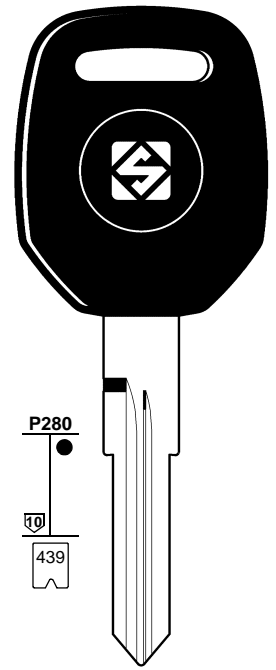

**NE77RT2**  
R.....  
6001-8000

**HON58RT6**  
..... 5001-8442

VALEO

FOR:  
PER:

# HONDA

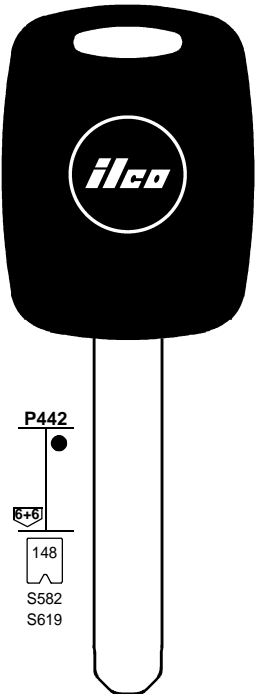

**EK3P-H003**  
..... (SUB) K001-N718  
..... (MAIN) K001-N718  
..... 5001-8442

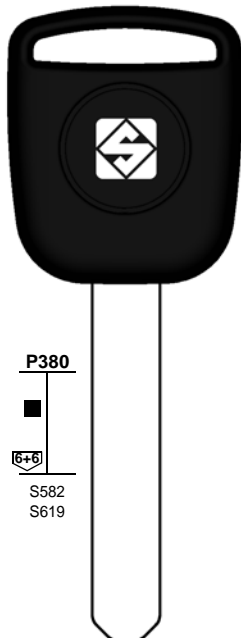

**HON66T5**  
..... (SUB) K001-N718  
..... (MAIN) K001-N718

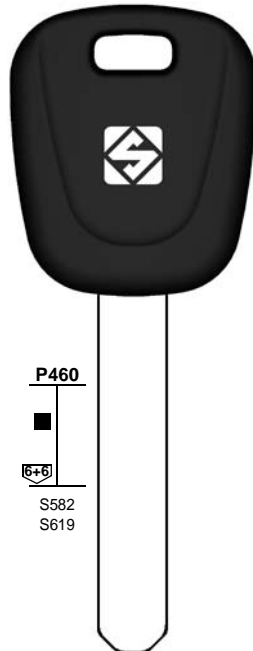

**HON66T6**  
..... (SUB) K001-N718  
..... (MAIN) K001-N718

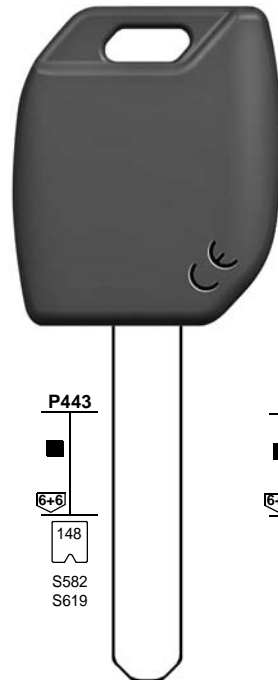

**HON66TE**  
..... (SUB) K001-N718  
..... (MAIN) K001-N718

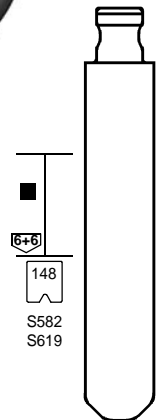



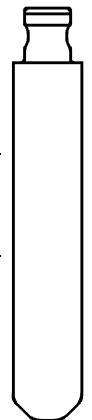















**HON66MH**  
..... (SUB) K001-N718  
..... (MAIN) K001-N718  
..... 5001-8442



**HON66FH**  
..... (SUB) K001-N718  
..... (MAIN) K001-N718

**HON66T14**  
..... (SUB) K001-N718  
..... (MAIN) K001-N718  
..... 5001-8442

**HON66T27**  
..... (SUB) K001-N718  
..... (MAIN) K001-N718  
..... 5001-8442

1	2	2a	3	3a	3b	e1+e2		6	42+71	72	43+44a	12	15
						GTI COMPATIBLE		IGNITION   					
CAR MAKE MODEL	FROM	TO	SILCA REF.	SILCA REF.	SILCA REF.	COPY	GEN.	TRANSP. TYPE	FAST COPY PLUS RW4 PLUS FAST COPY/RW4	FAST COPY PLUS RW4 PLUS	FAST COPY RW4	STP	
													
For more info on the uses of car keys, refer to the Silca Electronic Keys Catalogue: 													
<b>HONDA</b>													
ACCORD	1995	1999	NE77RT2					PH	33	Y	Y		
ACCORD	1999	2002	HON58RT6		HON58RFH			MEG / CR	48				
ACCORD	1999	2002	HON65RT6					MEG / CR	48				
ACCORD	2003	2006	HON66T14					PH / CR2	46				
ACCORD	2003	2006	HON66T6		HON66FH			MEG / CR	48				
ACCORD	2003	2006	HON66MH	HON66TE	HON66FH	Y	Y	PH / CR2	46	Y	P-BOX		
ACCORD	2006	2008	HON66T27		HON66FH			SOK / CR	8E				
ACCORD	2008		HON66T14					PH / CR2	46				
ACCORD	2008		HON66MH	HON66TE	HON66FH	Y	Y	PH / CR2	46	Y	P-BOX		
ACCORD	2008		EK3P-HO03					PH / CR2	46	Y	P-BOX		
ACCORD Aerodeck	1995	1997	HON58RT5		HON58RFH			MEG	13	Y	Y	Meg	
ACCORD Coupè	1995	2002	HON58RT5		HON58RFH			MEG	13	Y	Y	Meg	
CIVIC	1995	1999	HON58RT5		HON58RFH			MEG	13	Y	Y	Meg	
CIVIC	1999	2002	HON58RT6		HON58RFH			MEG / CR	48				
CIVIC	2002	2005	HON66T6		HON66FH			MEG / CR	48				
CIVIC	2006		HON66T14					PH / CR2	46				
CIVIC	2006		HON66MH	HON66TE	HON66FH	Y	Y	PH / CR2	46	Y	P-BOX		
CIVIC Aerodeck	1998	2000	NE77RT2					PH	33	Y	Y		
CIVIC (Australia)	2002	2005	HON66T5		HON66FH			MEG	13	Y	Y	Meg	
CIVIC (Australia)	2003		HON66T14					PH / CR2	46				
CIVIC (Australia)	2003		HON66MH	HON66TE	HON66FH	Y	Y	PH / CR2	46	Y	P-BOX		
CIVIC (5 doors)	1995	1995	NE77RDP										
CIVIC (5 doors)	1996	2000	NE77RT2					PH	33	Y	Y		
CR-V	1997	1999	HON58RT5		HON58RFH			MEG	13	Y	Y	Meg	
CR-V	1999	2001	HON58RT6		HON58RFH			MEG / CR	48				
CR-V	2002	2006	HON66T6		HON66FH			MEG / CR	48				
CR-V	2007		HON66T14					PH / CR2	46				
CR-V	2007		HON66MH	HON66TE	HON66FH	Y	Y	PH / CR2	46	Y	P-BOX		
CR-V (Australia)	2002	2006	HON66T5		HON66FH			MEG	13	Y	Y	Meg	
CR-Z	2010		HON66T14					PH / CR2	46				
CR-Z	2010		EK3P-HO03					PH / CR2	46	Y	P-BOX		
CR-Z	2010		HON66MH	HON66TE	HON66FH	Y	Y	PH / CR2	46	Y	P-BOX		
FR-V	2004	2007	HON66T6		HON66FH			MEG / CR	48				
FR-V	2007		HON66T27		HON66FH			SOK / CR	8E				
HR-V	1999	2005	HON58RT6		HON58RFH			MEG / CR	48				
INSIGHT	2001	2005	HON58RT6		HON58RFH			MEG / CR	48				
INSIGHT	2009							PH / CR2	46				
INSIGHT	2009		HON66MH	HON66TE	HON66FH	Y	Y	PH / CR2	46	Y	P-BOX		
INTEGRA	1998	2001	HON58RT5		HON58RFH			MEG	13	Y	Y	Meg	
JAZZ	2001	2007	HON66T6		HON66FH			MEG / CR	48				
JAZZ	2006	2008	HON66T27		HON66FH			SOK / CR	8E				
JAZZ	2009							PH / CR2	46				
JAZZ	2009		HON66MH	HON66TE	HON66FH	Y	Y	PH / CR2	46	Y	P-BOX		
JAZZ (Australia)	2001		HON66T5		HON66FH			MEG	13	Y	Y	Meg	
LEGEND	1996	2004	HON58RT5		HON58RFH			MEG	13	Y	Y	Meg	
LEGEND	2007		HON66T27		HON66FH			SOK / CR	8E				



FOR:  
PER:

# HONDA - HONDA USA

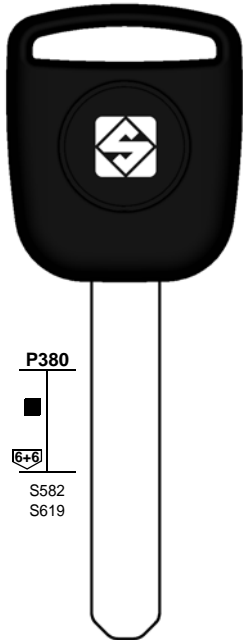

**HON66T6**

..... (SUB) K001-N718  
..... (MAIN) K001-N718

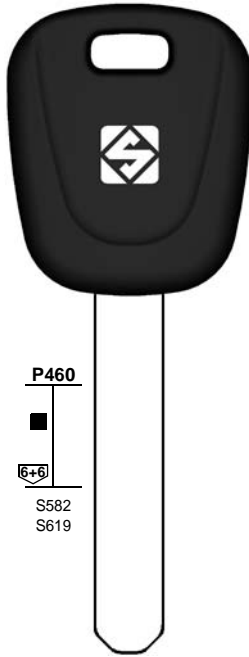

**HON66TE**

..... (SUB) K001-N718  
..... (MAIN) K001-N718

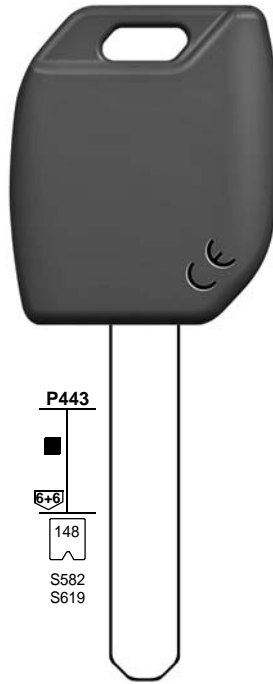

**HON66MH**

..... (SUB) K001-N718  
..... (MAIN) K001-N718  
..... 5001-8442

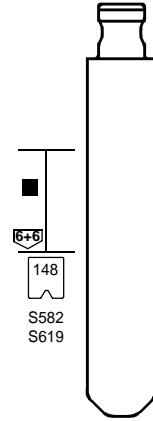

**HON66FH**

..... (SUB) K001-N718  
..... (MAIN) K001-N718



**HON66T14**

**HON66T27**

..... (SUB) K001-N718  
..... (MAIN) K001-N718  
..... 5001-8442

FOR:  
PER:

# HONDA - HONDA USA

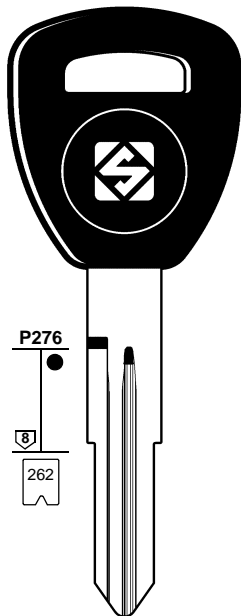

**HON58RT5**

..... 5001-8442

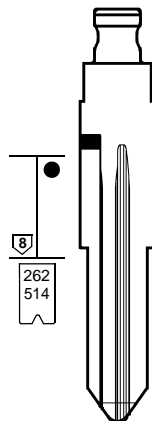

**HON58RFH**

..... 5001-8442  
..... 10001-15000

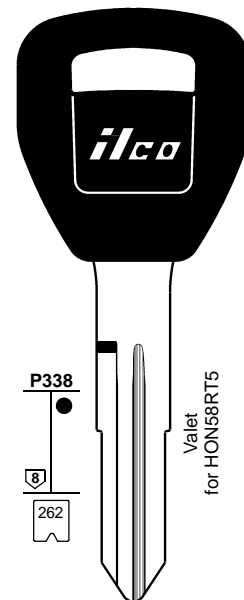

**HD107-PT5**

..... 5001-8442



**HON58RT6**

..... 5001-8442



FOR:  
PER:

# HONDA USA

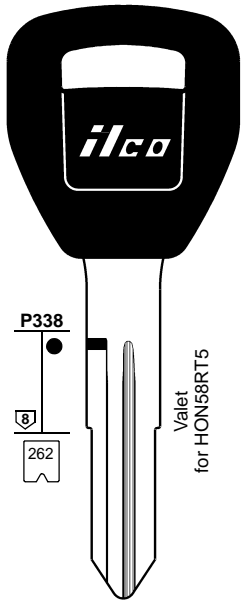

P338



Valet  
for HON58RT5

  
**HD107-PT5**  
..... 5001-8442

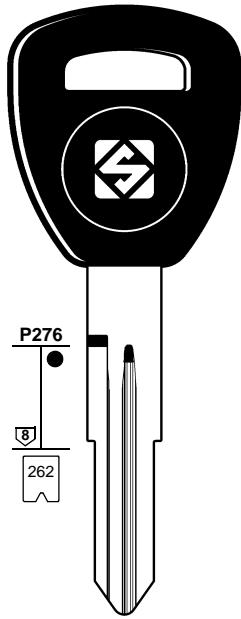

P276



  
**HON58RT5**  
..... 5001-8442

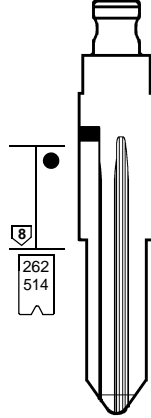

 **FH**  
**HON58RFH**  
..... 5001-8442  
..... 10001-15000

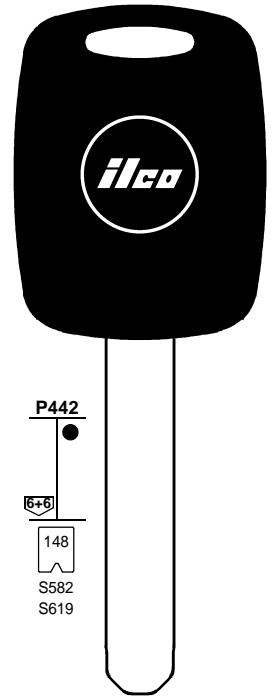

P442



  
**EK3P-HO03**  
..... (SUB) K001-N718  
..... (MAIN) K001-N718  
..... 5001-8442

FOR:  
PER:

# HONDA USA

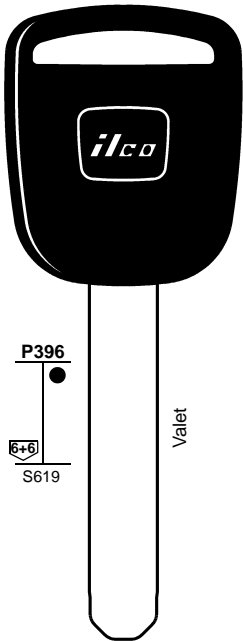

P396



Valet

  
**HOV01T5**  
..... (SUB) K001-N718

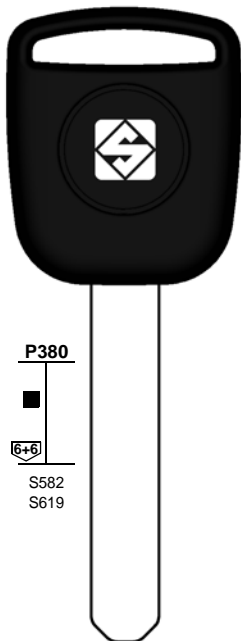

P380



S582  
S619

  
**HON66T5**  
..... (SUB) K001-N718  
..... (MAIN) K001-N718

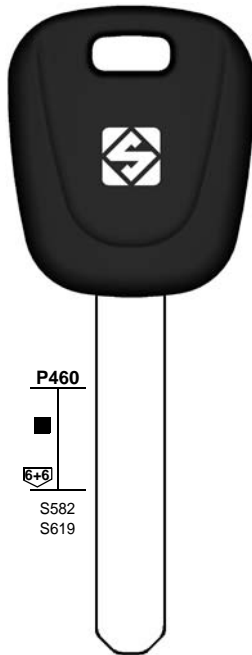

P460



S582  
S619

 **TE**  
**HON66TE**  
..... (SUB) K001-N718  
..... (MAIN) K001-N718

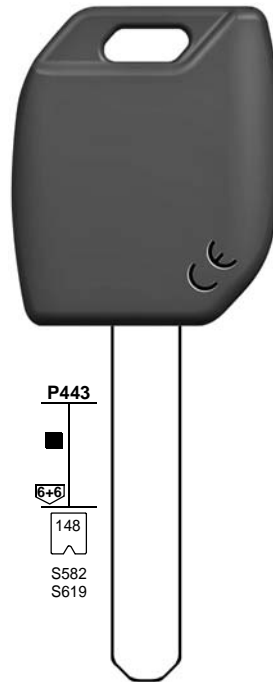

P443



148  
S582  
S619

 **MH**  
**HON66MH**  
..... (SUB) K001-N718  
..... (MAIN) K001-N718  
..... 5001-8442

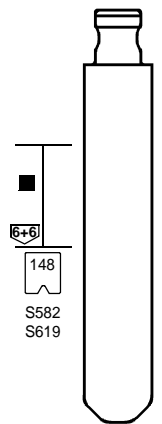

148  
S582  
S619

 **FH**  
**HON66FH**  
..... (SUB) K001-N718  
..... (MAIN) K001-N718

  
**HON66T14**  
..... (SUB) K001-N718  
..... (MAIN) K001-N718  
..... 5001-8442

  
**HON66T27**  
..... (SUB) K001-N718  
..... (MAIN) K001-N718  
..... 5001-8442

1	2	2a	3	3a	3b	e1+e2		6	42+71	72	43+44a	12	15
						GTI COMPATIBLE		IGNITION					
CAR MAKE MODEL	FROM	TO	SILCA REF.	SILCA REF.	SILCA REF.	COPY	GEN.	TRANSP. TYPE	FAST COPY PLUS RW4 PLUS FAST COPY/RW4	FAST COPY PLUS RW4 PLUS	FAST COPY RW4	STP	
For more info on the uses of car keys, refer to the Silca Electronic Keys Catalogue:													
<b>HONDA USA</b>													
ACCORD	2008		EK3P-HO03					PH / CR2	46	Y	P-BOX		
ACCORD CrossT	2010		HON66T14					PH / CR2	46				
ACCORD CrossT	2010		EK3P-HO03					PH / CR2	46	Y	P-BOX		
ACCORD CrossT	2010		HON66MH	HON66TE	HON66FH	Y	Y	PH / CR2	46	Y	P-BOX		
CIVIC	2001	2002	HD107-PT5					MEG	13	Y	Y		
CIVIC	2001	2002	HON58RT5		HON58RFH			MEG	13	Y	Y		
CIVIC	2003	2005	HON66T5		HON66FH			MEG	13	Y	Y		
CIVIC	2003	2005	HOV01T5					MEG	13	Y	Y		
CIVIC	2006		HON66T14					PH / CR2	46				
CIVIC	2006		HON66MH	HON66TE	HON66FH	Y	Y	PH / CR2	46	Y	P-BOX		
CR-V	2002	2006	HON66T5		HON66FH			MEG	13	Y	Y		
CR-V	2002	2006	HOV01T5					MEG	13	Y	Y		
CR-V	2007		HON66T14					PH / CR2	46				
CR-V	2007		HON66MH	HON66TE	HON66FH	Y	Y	PH / CR2	46	Y	P-BOX		
CR-Z	2011		HON66T14					PH / CR2	46				
CR-Z	2011		HON66MH	HON66TE	HON66FH	Y	Y	PH / CR2	46	Y	P-BOX		
CR-Z	2011		EK3P-HO03					PH / CR2	46	Y	P-BOX		
ELEMENT	2003	2005	HON66T5		HON66FH			MEG	13	Y	Y		
ELEMENT	2006	2011	HON66T14					PH / CR2	46				
ELEMENT	2006	2011	HON66MH	HON66TE	HON66FH	Y	Y	PH / CR2	46	Y	P-BOX		
FIT	2007	2008	HON66T27		HON66FH			SOK / CR	8E				
FIT	2009		HON66T14					PH / CR2	46				
FIT	2009		HON66MH		HON66FH	Y	Y	PH / CR2	46	Y	P-BOX		
INSIGHT	2000	2006	HD107-PT5					MEG	13	Y	Y		
INSIGHT	2000	2006	HON58RT5		HON58RFH			MEG	13	Y	Y		
INSIGHT	2010		HON66T14					PH / CR2	46				
INSIGHT	2010		HON66MH	HON66TE	HON66FH	Y	Y	PH / CR2	46	Y	P-BOX		
INSIGHT	2010		EK3P-HO03					PH / CR2	46	Y	P-BOX		
ODYSSEY	1998	2002	HON58RT5		HON58RFH			MEG	13	Y	Y		
ODYSSEY	1998	2002	HD107-PT5					MEG	13	Y	Y		
ODYSSEY	2003	2004	HON66T5		HON66FH			MEG	13	Y	Y		
ODYSSEY	2003	2004	HOV01T5					MEG	13	Y	Y		
ODYSSEY	2005		HON66T14					PH / CR2	46				
ODYSSEY	2005		HON66MH	HON66TE	HON66FH	Y	Y	PH / CR2	46	Y	P-BOX		
PILOT	2003	2005	HON66T5		HON66FH			MEG	13	Y	Y		
PILOT	2003	2005	HOV01T5					MEG	13	Y	Y		
PILOT	2006		HON66T14					PH / CR2	46				
PILOT	2006		HON66MH	HON66TE	HON66FH	Y	Y	PH / CR2	46	Y	P-BOX		
PRELUDE	1997	2002	HON58RT5		HON58RFH			MEG	13	Y	Y	Meg	
PRELUDE	1997	2002	HD107-PT5					MEG	13	Y	Y	Meg	
RIDGELINE	2005		HON66T14					PH / CR2	46				
RIDGELINE	2005		HON66MH	HON66TE	HON66FH	Y	Y	PH / CR2	46	Y	P-BOX		
S2000	2000	2002	HD107-PT5					MEG	13	Y	Y		
S2000	2000	2002	HON58RT5		HON58RFH			MEG	13	Y	Y		
S2000	2003	2005	HON66T5		HON66FH			MEG	13	Y	Y		
S2000	2006	2010	HON66T27		HON66FH			SOK / CR	8E				

FOR:  
PER:

# HUMMER

# HYUNDAI

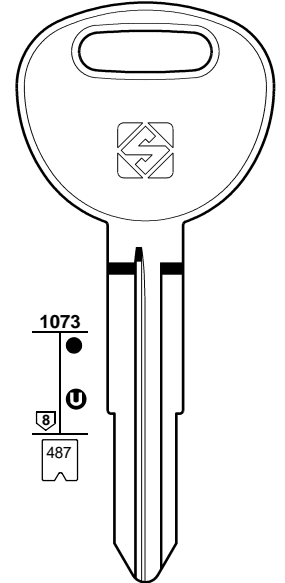
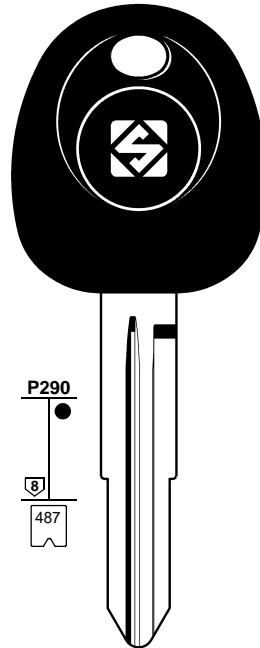
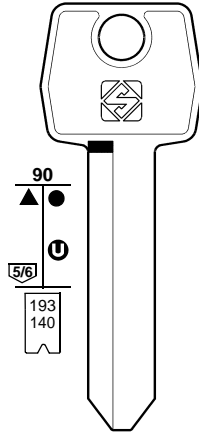
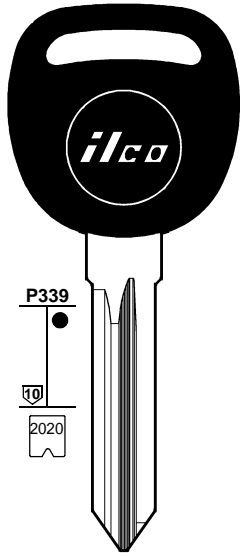
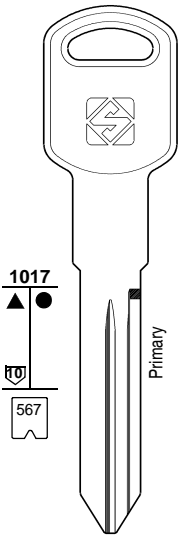

**GM39**

.... AA00-7T51  
.... S000A-S711K

**B111-PT**

G.... 0-3631

**F06**

AF.... 1-2700  
FA.... 0-1863  
PA.... 0-1863

**HYN6T14**

T.... 1-1000

**HYN10**

R.... 1-1000  
K.... 1-1000

**BRIGGS & STRATTON  
GENERAL MOTORS**

FOR:  
PER:

# HYUNDAI

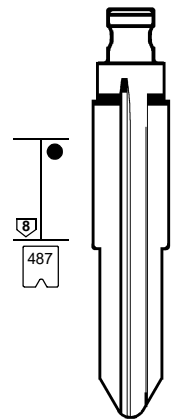
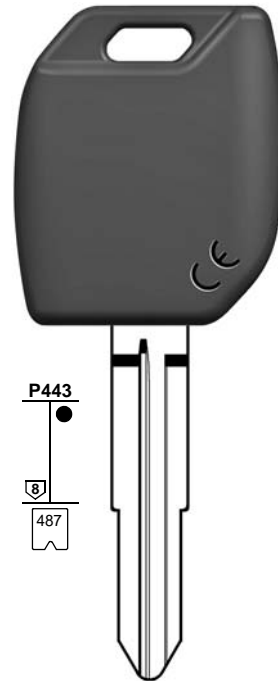
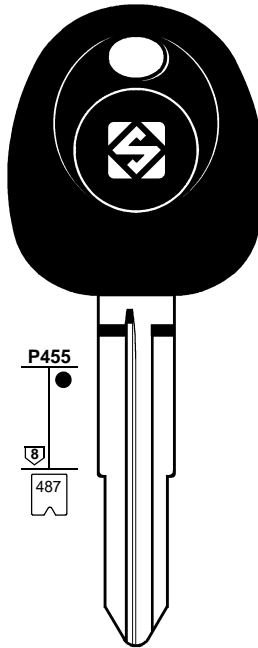
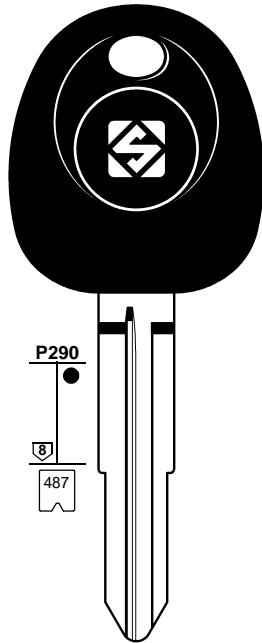
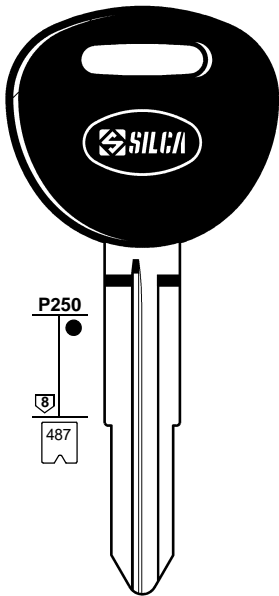

**HYN10BP**

R.... 1-1000  
K.... 1-1000

**HYN10T4**

R.... 1-1000  
X.... 1-1000

**HYN10TE**

R.... 1-1000  
K.... 1-1000

**HYN10MH**

X.... 1-1000  
R.... 1-1000

**HYN10FH**

R.... 1-1000  
K.... 1-1000  
X.... 1-1000



FOR:  
PER:

# HYUNDAI

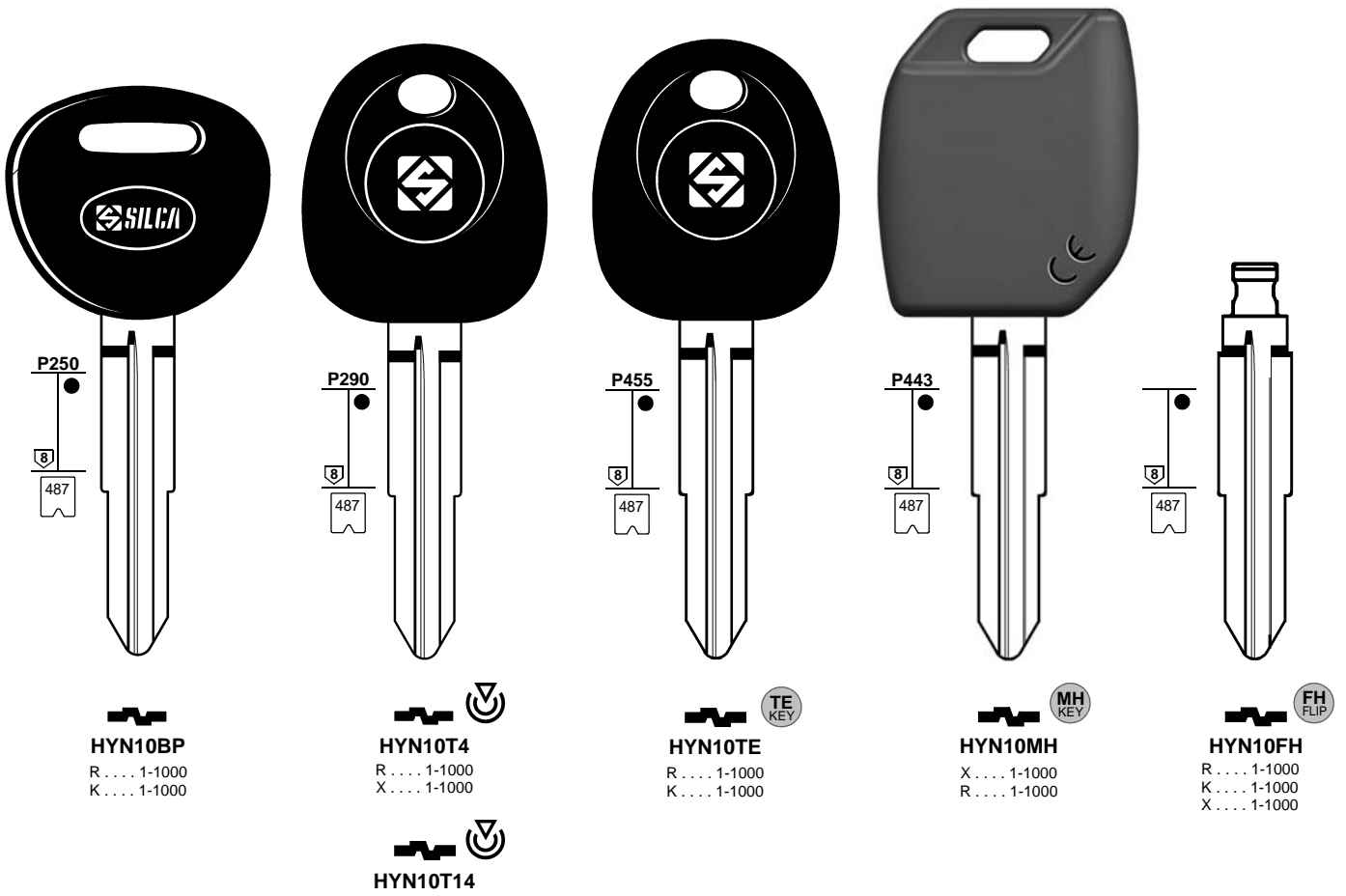

FOR:  
PER:

# HYUNDAI

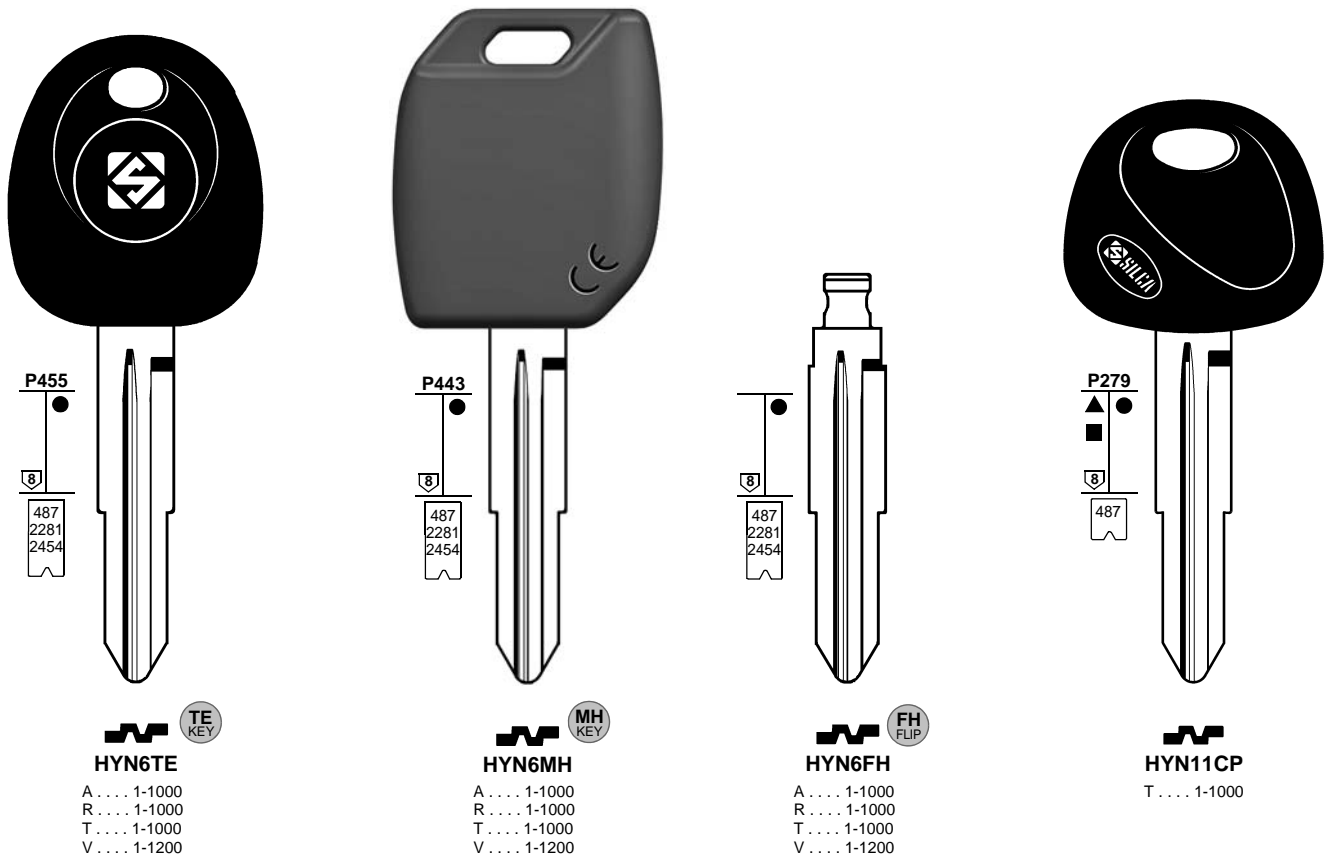





FOR:  
PER:

# HYUNDAI

**P322**  
S819  
S853  
S1001  
S1122  
S1150

**P443**  
480  
S24  
S232  
S765  
S819  
S853  
S1001  
S1122  
S1150  
S1356

480  
S24  
S232  
S765  
S819  
S853  
S1001  
S1122  
S1150  
S1356

**P290**  
487

**P455**  
487  
2281  
2454

**KIA7T14**  
G.... 0001-2500  
J.... 0001-2500  
K.... 0001-2500  
L.... 0001-1000  
P.... 0001-2500

**TOY40MH**  
.... 1-5000  
L.... 0001-1000  
G.... 0001-2500  
J.... 0001-2500  
K.... 0001-2500  
P.... 0001-2500  
.... 30001-31200

**TOY40FH**  
.... 1-5000  
L.... 0001-1000  
J.... 0001-2500

**HYN6T4**  
T.... 1-1000

**HYN6TE**  
A.... 1-1000  
R.... 1-1000  
T.... 1-1000  
V.... 1-1200

**HYN6T14**  
T.... 1-1000

FOR:  
PER:

# HYUNDAI

**P443**  
487  
2281  
2454

487  
2281  
2454

**P290**  
2281  
2503

**P455**  
2503  
3667

**P443**  
2503  
3003

10  
2503  
3003  
3667

**HYN6MH**  
A.... 1-1000  
R.... 1-1000  
T.... 1-1000  
V.... 1-1200

**HYN6FH**  
A.... 1-1000  
R.... 1-1000  
T.... 1-1000  
V.... 1-1200

**HYN14RT14**  
M.... 1-2500  
T.... 1-2500  
WC.... 1001-3500

**HYN14RTE**  
M.... 1-2500  
T.... 1-2500  
WC.... 1001-3500

**HYN14RMH**  
M.... 1-2500  
T.... 1-2500  
WC.... 1001-3500

**HYN14RFH**  
M.... 1-2500  
T.... 1-2500  
WC.... 1001-3500



FOR:  
PER:

# HYUNDAI

**HYN11**  
T ..... 1-1000

**HYN11CP**  
T ..... 1-1000

**HYN14T14**  
H ..... 0001-2500  
M ..... 0001-2500  
P ..... 0001-2500  
T ..... 0001-2500  
V ..... 1-2500

**HYN14TE**  
H ..... 0001-2500  
M ..... 0001-2500  
P ..... 0001-2500  
T ..... 0001-2500  
V ..... 1-2500

**HYN14MH**  
H ..... 0001-2500  
M ..... 0001-2500  
P ..... 0001-2500  
T ..... 0001-2500  
V ..... 0001-2500

**HYN14FH**  
H ..... 0001-2500  
M ..... 0001-2500  
P ..... 0001-2500  
T ..... 0001-2500  
V ..... 0001-2500

FOR:  
PER:

# HYUNDAI

**HYN10**  
R ..... 1-1000  
K ..... 1-1000

**HYN10BP**  
R ..... 1-1000  
K ..... 1-1000

**HYN10T4**  
R ..... 1-1000  
X ..... 1-1000

**HYN10TE**  
R ..... 1-1000  
K ..... 1-1000

**HYN10MH**  
X ..... 1-1000  
R ..... 1-1000

**HYN10FH**  
R ..... 1-1000  
K ..... 1-1000  
X ..... 1-1000



FOR:  
PER:

# HYUNDAI

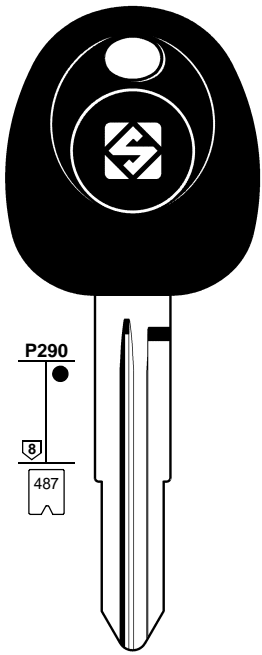

P290  
8  
487

**HYN6T4**  
T . . . . 1-1000

**HYN6T14**  
T . . . . 1-1000

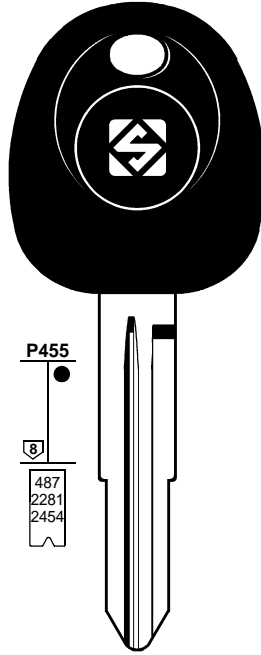

P455  
8  
487  
2281  
2454

**HYN6TE**  
A . . . . 1-1000  
R . . . . 1-1000  
T . . . . 1-1000  
V . . . . 1-1200

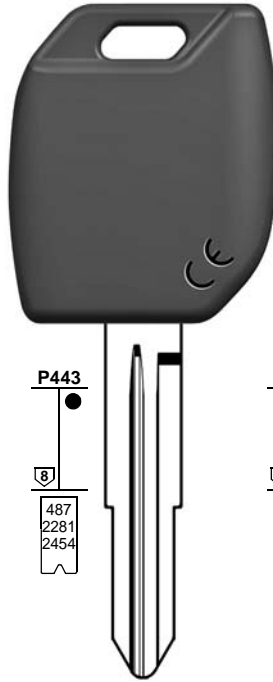

P443  
8  
487  
2281  
2454

**HYN6MH**  
A . . . . 1-1000  
R . . . . 1-1000  
T . . . . 1-1000  
V . . . . 1-1200

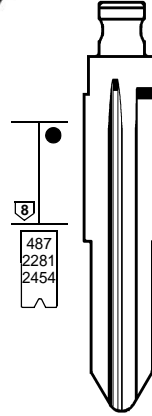

8  
487  
2281  
2454

**HYN6FH**  
A . . . . 1-1000  
R . . . . 1-1000  
T . . . . 1-1000  
V . . . . 1-1200



P322  
6/8  
S819  
S853  
S1001  
S1122  
S1150

**KIA7T14**  
G . . . . 0001-2500  
J . . . . 0001-2500  
K . . . . 0001-2500  
L . . . . 0001-1000  
P . . . . 0001-2500

FOR:  
PER:

# HYUNDAI

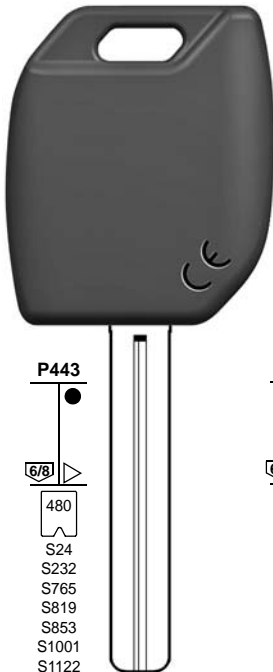

P443  
6/8  
480  
S24  
S232  
S765  
S819  
S853  
S1001  
S1122  
S1150  
S1356

**TOY40MH**  
. . . . 1-5000  
L . . . . 0001-1000  
G . . . . 0001-2500  
J . . . . 0001-2500  
K . . . . 0001-2500  
P . . . . 0001-2500  
. . . . 30001-31200

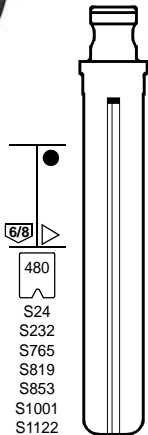

6/8  
480  
S24  
S232  
S765  
S819  
S853  
S1001  
S1122  
S1150  
S1356

**TOY40FH**  
. . . . 1-5000  
L . . . . 0001-1000  
J . . . . 0001-2500

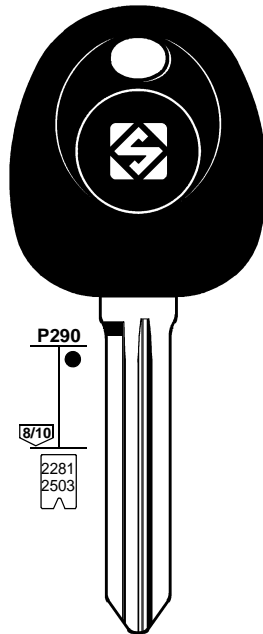

P290  
8/10  
2281  
2503

**HYN14RT14**  
M . . . . 1-2500  
T . . . . 1-2500  
WC . . . . 1001-3500

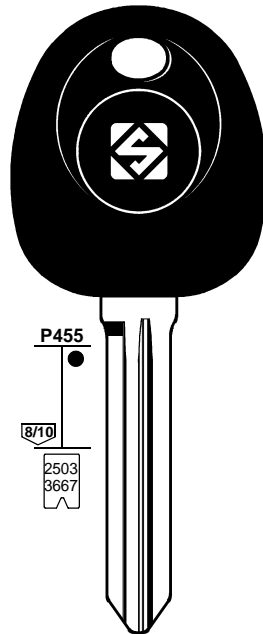

P455  
8/10  
2503  
3667

**HYN14RTE**  
M . . . . 1-2500  
T . . . . 1-2500  
WC . . . . 1001-3500

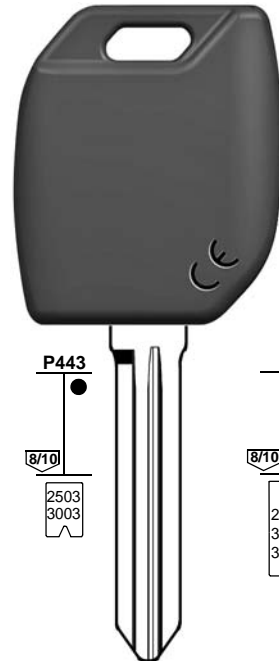

P443  
8/10  
2503  
3003

**HYN14RMH**  
M . . . . 1-2500  
T . . . . 1-2500  
WC . . . . 1001-3500

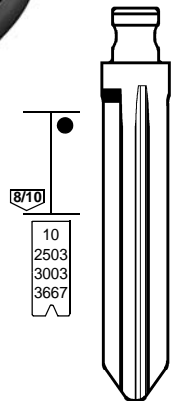

8/10  
10  
2503  
3003  
3667

**HYN14RFH**  
M . . . . 1-2500  
T . . . . 1-2500  
WC . . . . 1001-3500



FOR:  
PER:

# HYUNDAI

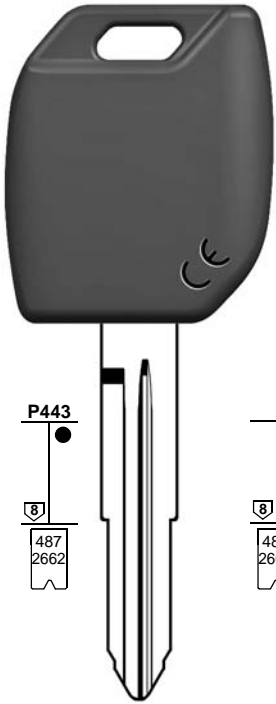

P443

487  
2662



**HYN7RMH**  
S ..... 1-1000

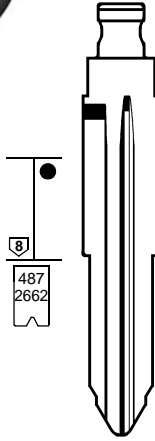

P443

487  
2662



**HYN7RFH**  
S ..... 1-1000

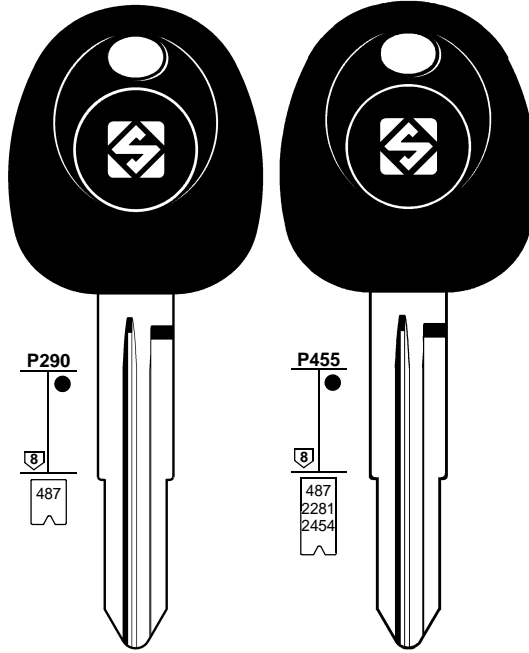

P290

487



**HYN6T4**  
T ..... 1-1000

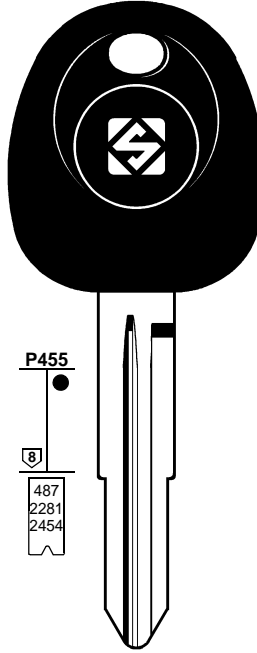

P455

487  
2281  
2454



**HYN6TE**  
A ..... 1-1000  
R ..... 1-1000  
T ..... 1-1000  
V ..... 1-1200

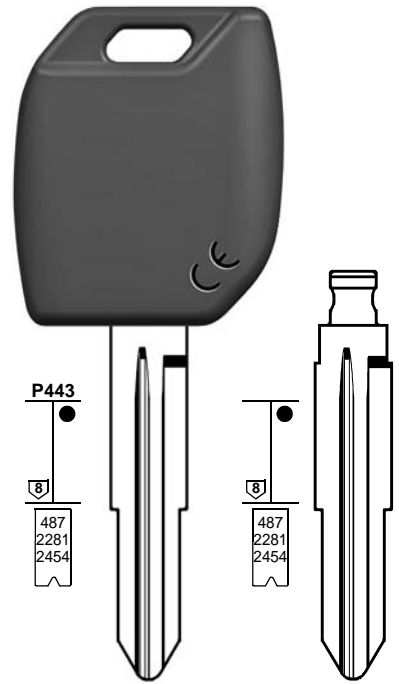

P443

487  
2281  
2454



**HYN6MH**  
A ..... 1-1000  
R ..... 1-1000  
T ..... 1-1000  
V ..... 1-1200

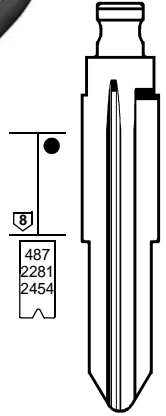

P443

487  
2281  
2454



**HYN6FH**  
A ..... 1-1000  
R ..... 1-1000  
T ..... 1-1000  
V ..... 1-1200



**HYN6T14**  
T ..... 1-1000

FOR:  
PER:

# HYUNDAI

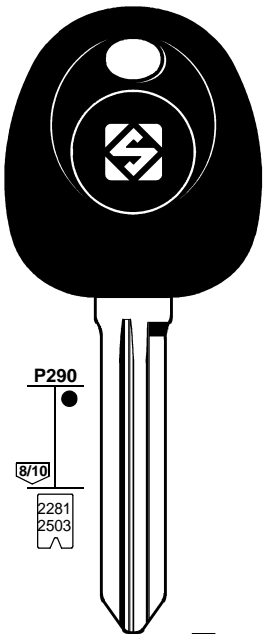

P290

2281  
2503



**HYN14T14**  
H ..... 0001-2500  
M ..... 0001-2500  
P ..... 0001-2500  
T ..... 0001-2500  
V ..... 1-2500

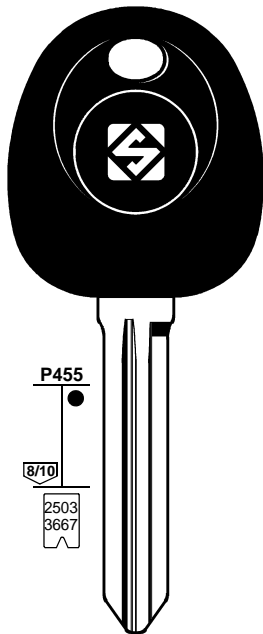

P455

2503  
3667



**HYN14TE**  
H ..... 0001-2500  
M ..... 0001-2500  
P ..... 0001-2500  
T ..... 0001-2500  
V ..... 1-2500

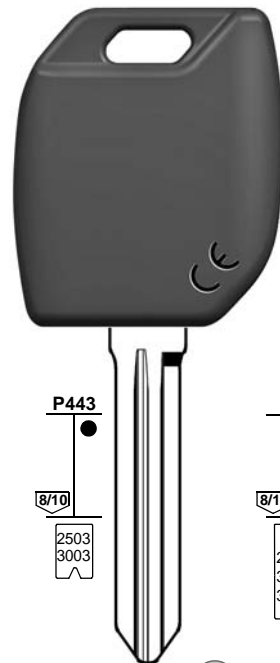

P443

2503  
3003



**HYN14MH**  
H ..... 0001-2500  
M ..... 0001-2500  
P ..... 0001-2500  
T ..... 0001-2500  
V ..... 0001-2500

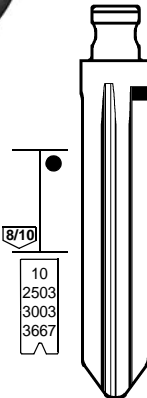

P443

10  
2503  
3003  
3667



**HYN14FH**  
H ..... 0001-2500  
M ..... 0001-2500  
P ..... 0001-2500  
T ..... 0001-2500  
V ..... 0001-2500

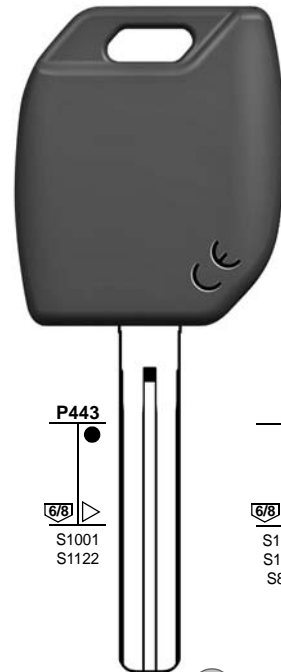

P443

S1001  
S1122



**TOY49MH**  
K ..... 0001-2500  
P ..... 0001-2500

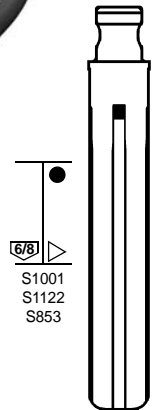

P443

S1001  
S1122  
S853



**TOY49FH**  
K ..... 0001-2500  
P ..... 0001-2500  
L ..... 0001-1000



**HYN14RTE**  
M ..... 1-2500  
T ..... 1-2500  
WC ..... 1001-3500



**HYN14RMH**  
M ..... 1-2500  
T ..... 1-2500  
WC ..... 1001-3500



**HYN14RFH**  
M ..... 1-2500  
T ..... 1-2500  
WC ..... 1001-3500





FOR:  
PER:

# HYUNDAI



P322  
6/8  
S819  
S853  
S1001  
S1122  
S1150



**KIA7T14**

G . . . . 0001-2500  
J . . . . 0001-2500  
K . . . . 0001-2500  
L . . . . 0001-1000  
P . . . . 0001-2500



P443  
6/8  
480  
S24  
S232  
S765  
S819  
S853  
S1001  
S1122  
S1150  
S1356



**TOY40MH**

. . . . 1-5000  
L . . . . 0001-1000  
G . . . . 0001-2500  
J . . . . 0001-2500  
K . . . . 0001-2500  
P . . . . 0001-2500  
. . . . 30001-31200

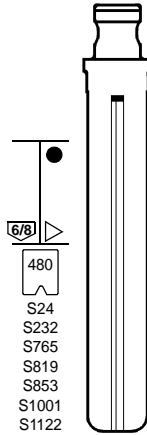

6/8  
480  
S24  
S232  
S765  
S819  
S853  
S1001  
S1122  
S1150  
S1356



**TOY40FH**

. . . . 1-5000  
L . . . . 0001-1000  
J . . . . 0001-2500

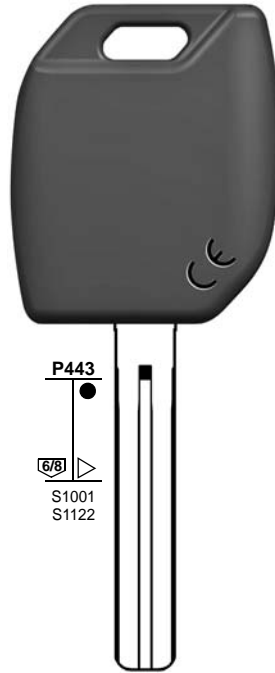

P443  
6/8  
S1001  
S1122



**TOY49MH**

K . . . . 0001-2500  
P . . . . 0001-2500

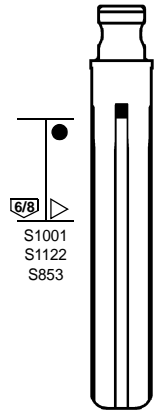

6/8  
S1001  
S1122  
S853



**TOY49FH**

K . . . . 0001-2500  
P . . . . 0001-2500  
L . . . . 0001-1000

FOR:  
PER:

# HYUNDAI

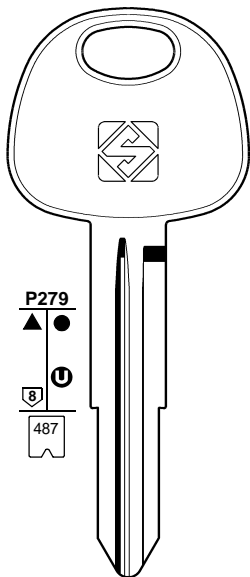

P279  
8  
487

**HYN11**

T . . . . 1-1000

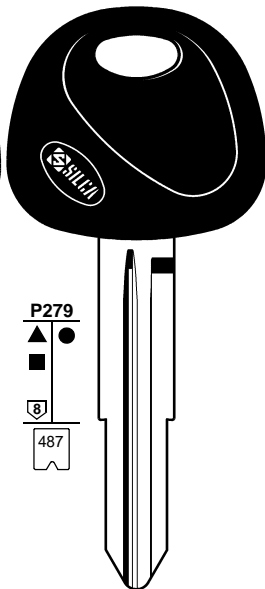

P279  
8  
487

**HYN11CP**

T . . . . 1-1000

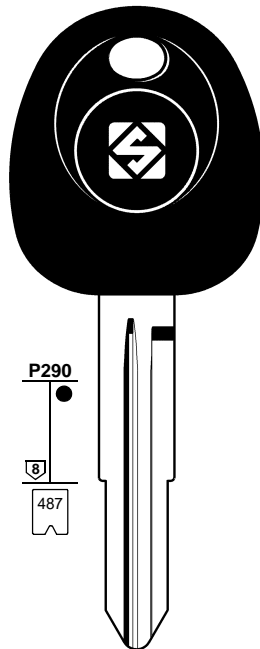

P290  
8  
487

**HYN6T4**

T . . . . 1-1000

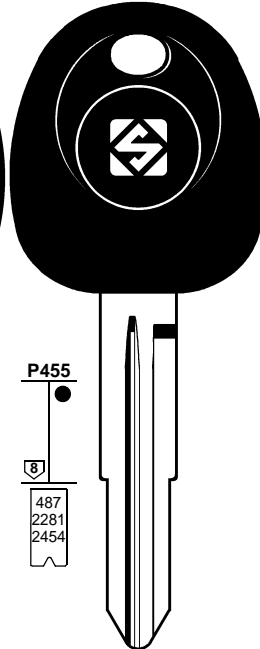

P455  
8  
487  
2281  
2454

**HYN6TE**

A . . . . 1-1000  
R . . . . 1-1000  
T . . . . 1-1000  
V . . . . 1-1200

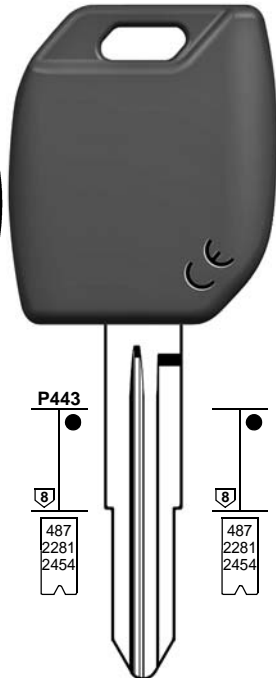

P443  
8  
487  
2281  
2454

**HYN6MH**

A . . . . 1-1000  
R . . . . 1-1000  
T . . . . 1-1000  
V . . . . 1-1200

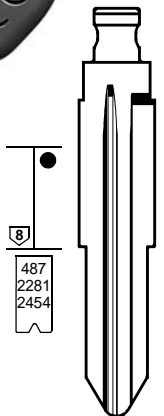

8  
487  
2281  
2454

**HYN6FH**

A . . . . 1-1000  
R . . . . 1-1000  
T . . . . 1-1000  
V . . . . 1-1200



FOR:  
PER:

# HYUNDAI

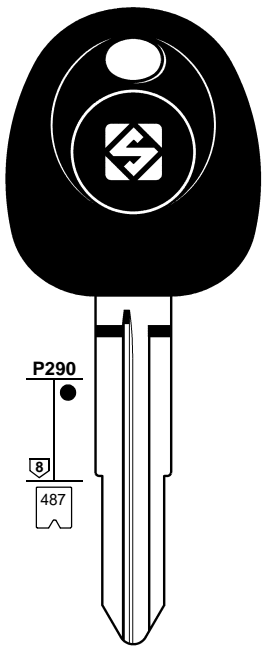

**HYN10T4**  
R ..... 1-1000  
X ..... 1-1000

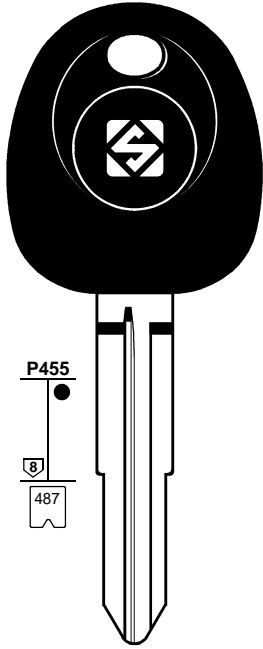

**HYN10TE**  
R ..... 1-1000  
X ..... 1-1000

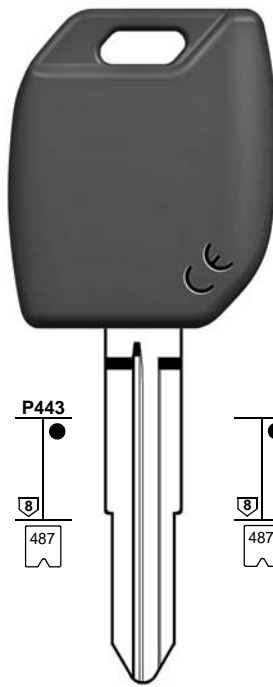

**HYN10MH**  
X ..... 1-1000  
R ..... 1-1000

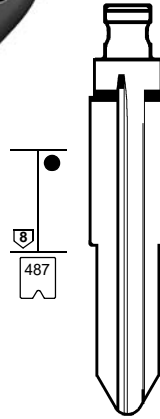

**HYN10FH**  
R ..... 1-1000  
K ..... 1-1000  
X ..... 1-1000

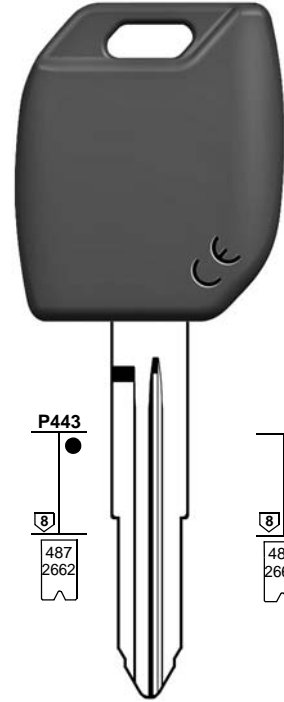

**HYN7RMH**  
S ..... 1-1000

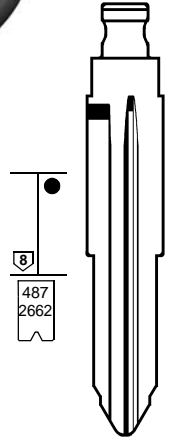

**HYN7RFH**  
S ..... 1-1000

FOR:  
PER:

# HYUNDAI

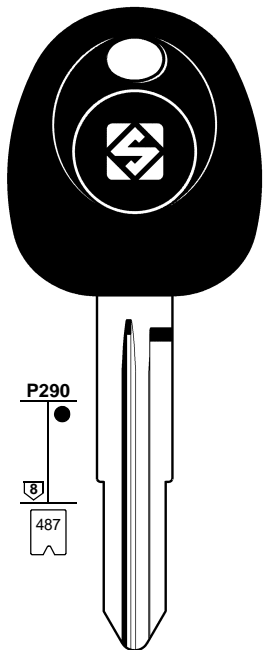

**HYN6T14**  
T ..... 1-1000

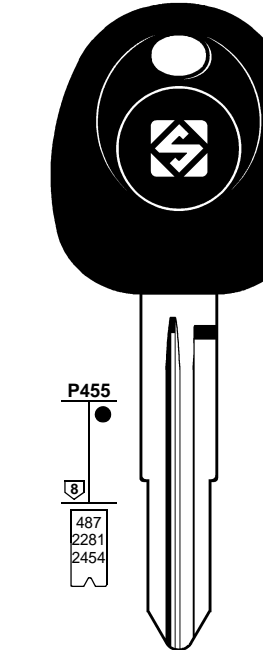

**HYN6TE**  
A ..... 1-1000  
R ..... 1-1000  
T ..... 1-1000  
V ..... 1-1200

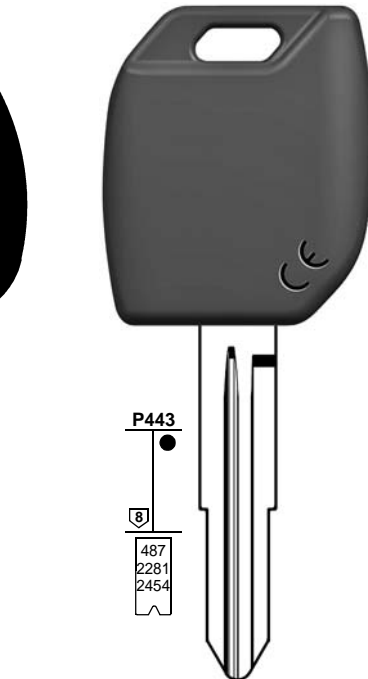

**HYN6MH**  
A ..... 1-1000  
R ..... 1-1000  
T ..... 1-1000  
V ..... 1-1200

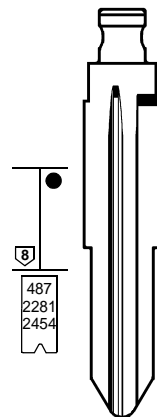

**HYN6FH**  
A ..... 1-1000  
R ..... 1-1000  
T ..... 1-1000  
V ..... 1-1200

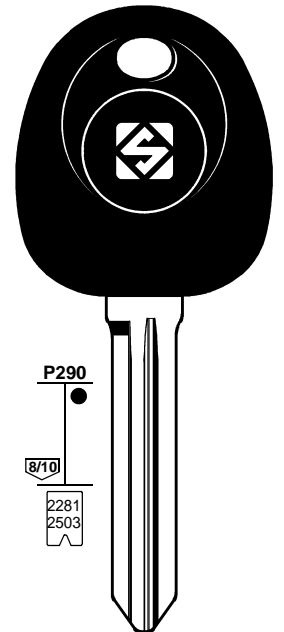

**HYN14RT14**  
M ..... 1-2500  
T ..... 1-2500  
WC ..... 1001-3500



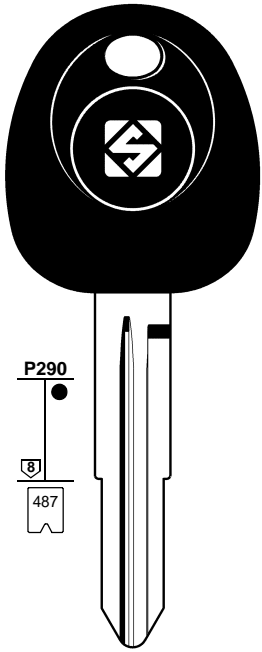

FOR:  
PER:

# HYUNDAI

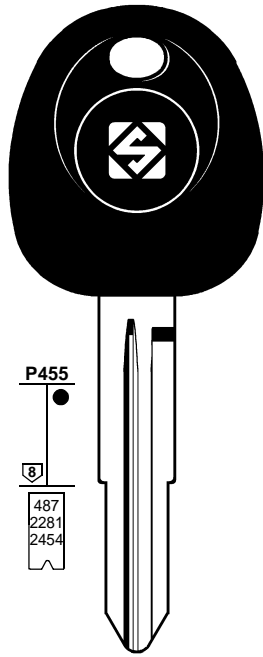

  
**HYN6T4**  
T . . . . 1-1000



 **TE KEY**  
**HYN6TE**  
A . . . . 1-1000  
R . . . . 1-1000  
T . . . . 1-1000  
V . . . . 1-1200

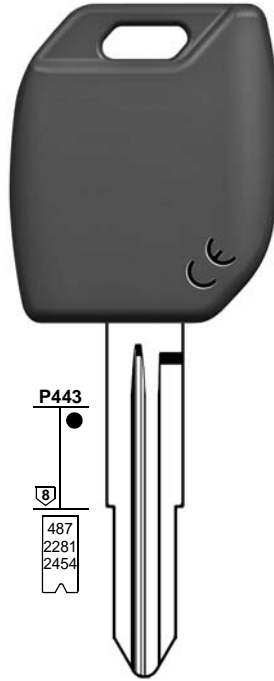

 **MH KEY**  
**HYN6MH**  
A . . . . 1-1000  
R . . . . 1-1000  
T . . . . 1-1000  
V . . . . 1-1200

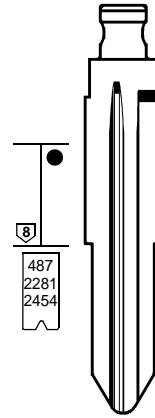

 **FH FLIP**  
**HYN6FH**  
A . . . . 1-1000  
R . . . . 1-1000  
T . . . . 1-1000  
V . . . . 1-1200

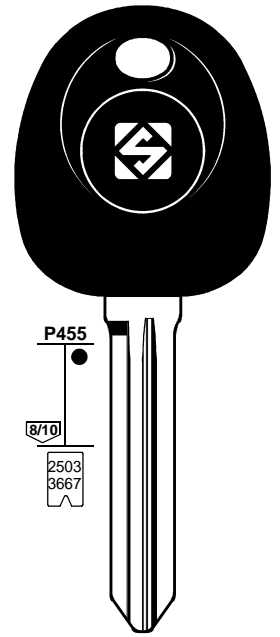

 **TE KEY**  
**HYN14RTE**  
M . . . . 1-2500  
T . . . . 1-2500  
WC . . . . 1001-3500

FOR:  
PER:

# HYUNDAI

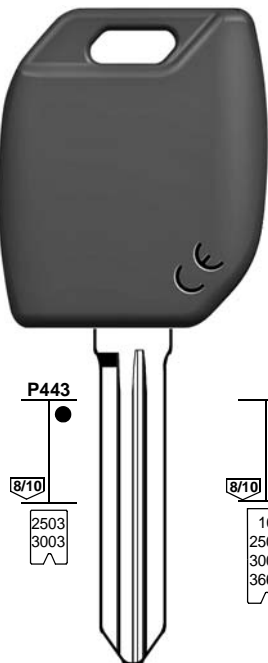

 **MH KEY**  
**HYN14RMH**  
M . . . . 1-2500  
T . . . . 1-2500  
WC . . . . 1001-3500



 **FH FLIP**  
**HYN14RFH**  
M . . . . 1-2500  
T . . . . 1-2500  
WC . . . . 1001-3500

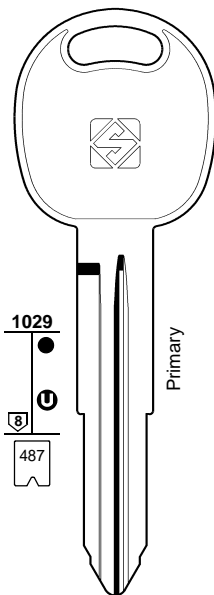

  
**HYN7R**  
S . . . . 1-1000

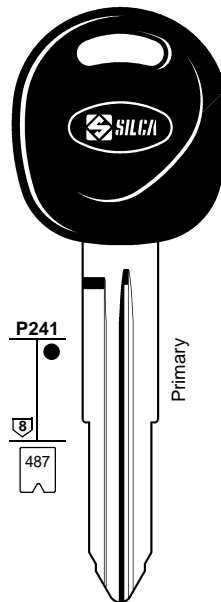

  
**HYN7RAP**  
S . . . . 1-1000

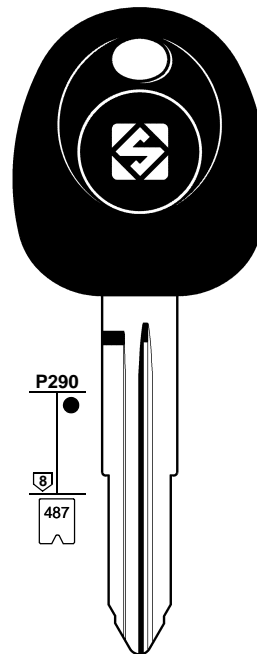

  
**HYN7RT4**  
S . . . . 1-1000

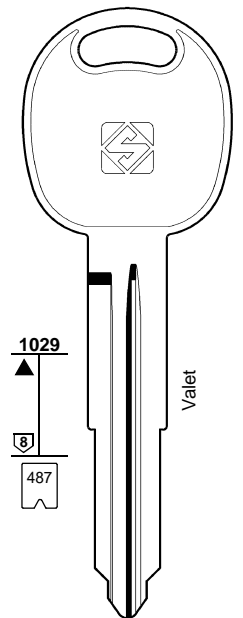

  
**HYN8R**  
S . . . . 1-1000



FOR:  
PER:

# HYUNDAI

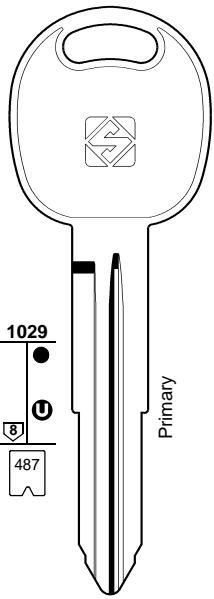

Primary

1029  
487



**HYN7R**

S . . . . 1-1000

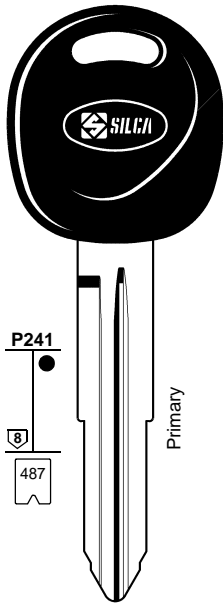

Primary

P241  
487



**HYN7RAP**

S . . . . 1-1000

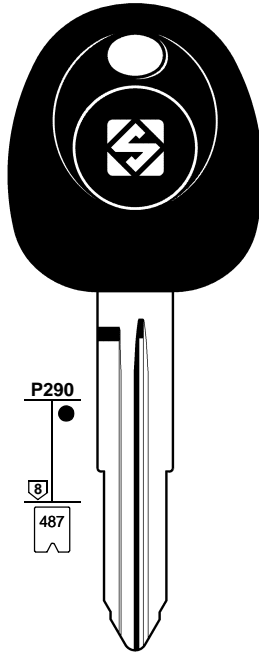

P290  
487



**HYN7RT4**

S . . . . 1-1000

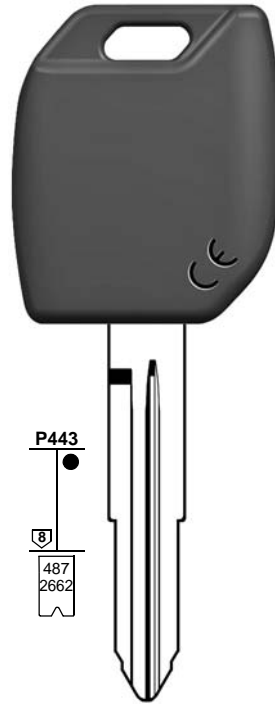

P443  
487  
2662



**HYN7RMH**

S . . . . 1-1000

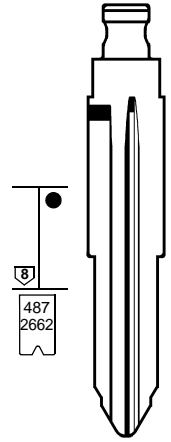

487  
2662



**HYN7RFH**

S . . . . 1-1000

FOR:  
PER:

# HYUNDAI

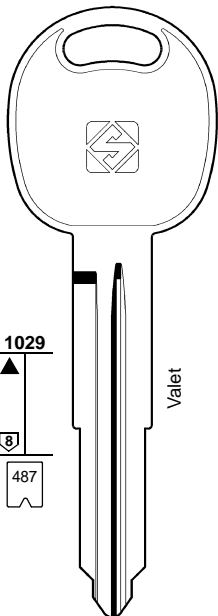

Valet

1029  
487



**HYN8R**

S . . . . 1-1000

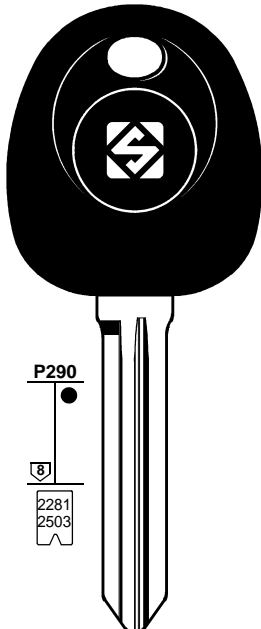

P290  
2281  
2503



**HYN14RT14**

M . . . . 1-2500  
T . . . . 1-2500  
WC . . . . 1001-3500

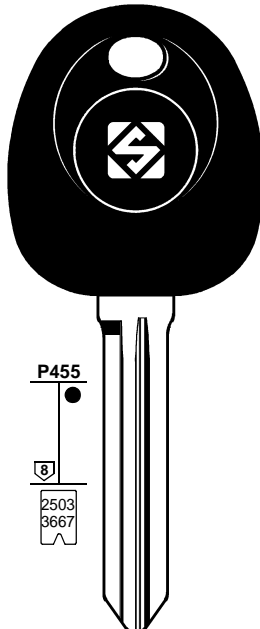

P455  
2503  
3667



**HYN14RTE**

M . . . . 1-2500  
T . . . . 1-2500  
WC . . . . 1001-3500

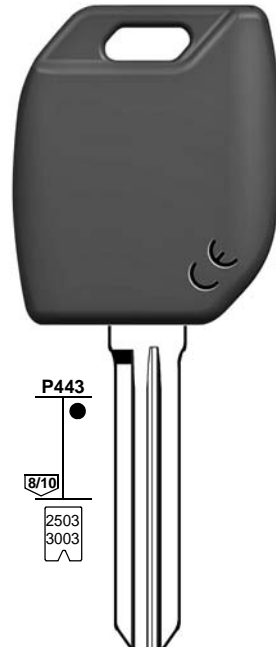

P443  
2503  
3003



**HYN14RMH**

M . . . . 1-2500  
T . . . . 1-2500  
WC . . . . 1001-3500

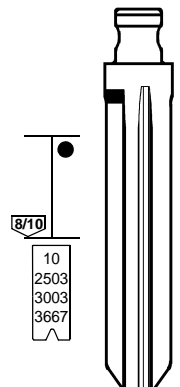

10  
2503  
3003  
3667



**HYN14RFH**

M . . . . 1-2500  
T . . . . 1-2500  
WC . . . . 1001-3500





FOR:  
PER:

# HYUNDAI

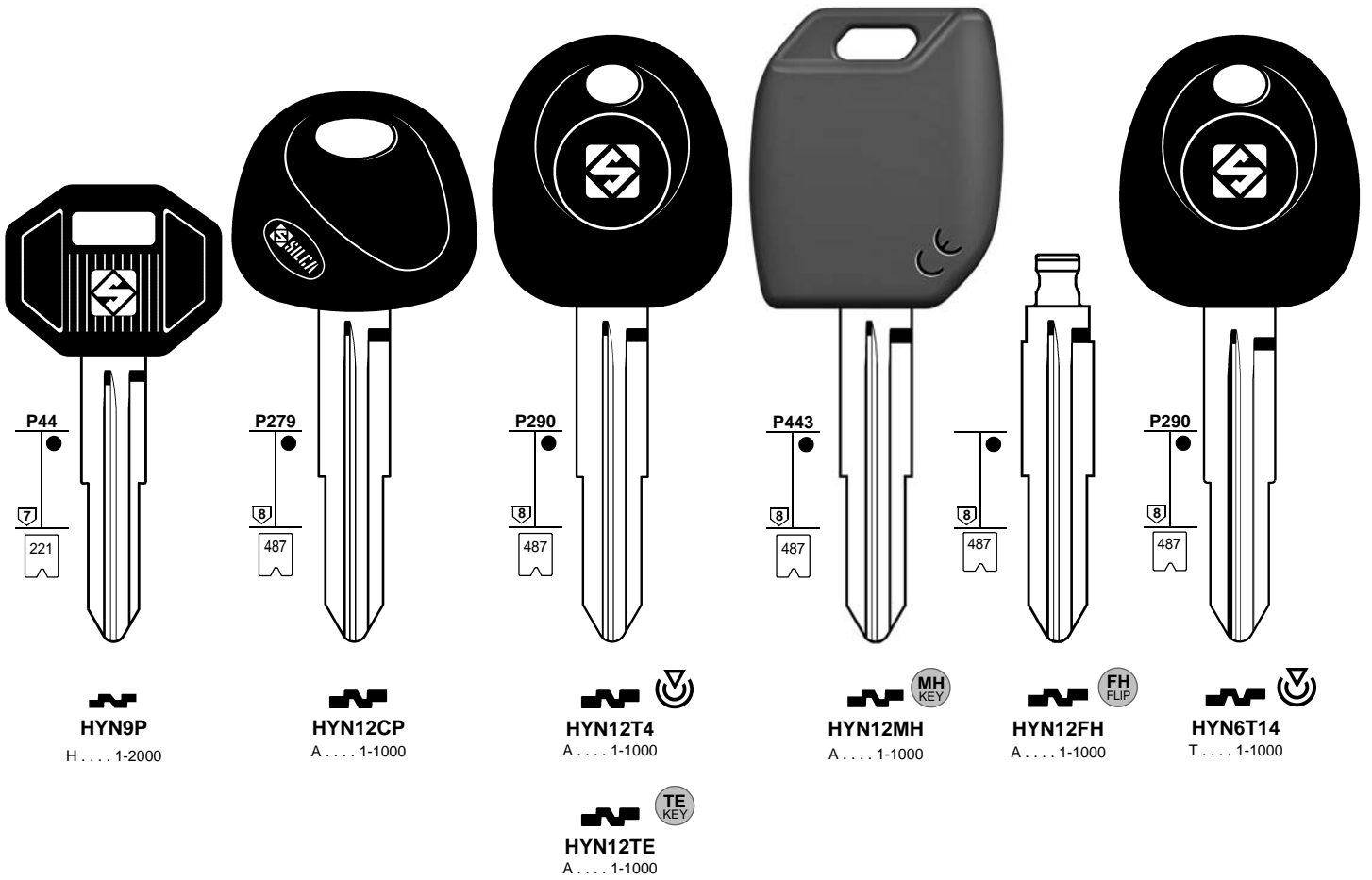

FOR:  
PER:

# HYUNDAI

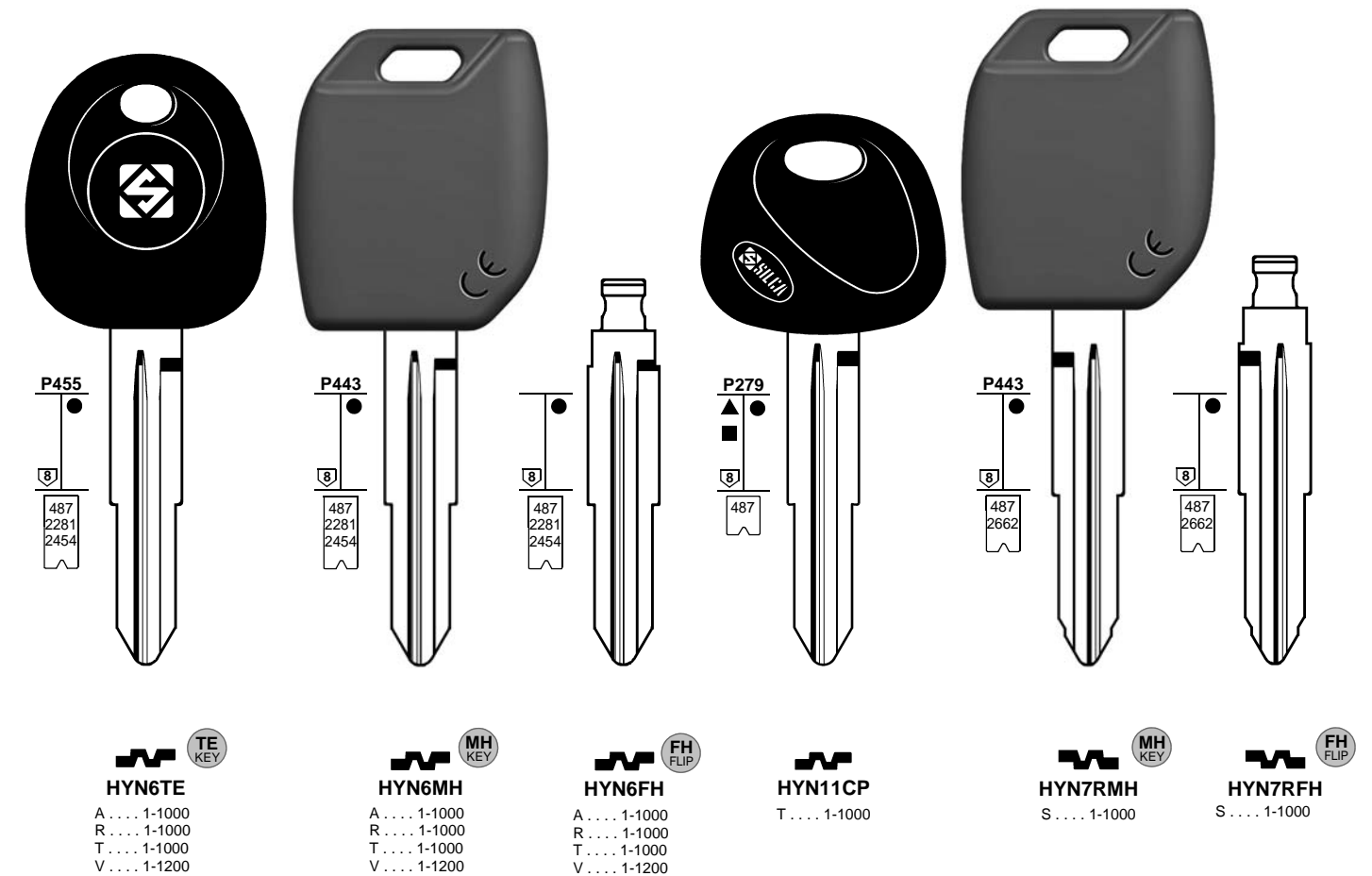



FOR:  
PER:

# HYUNDAI

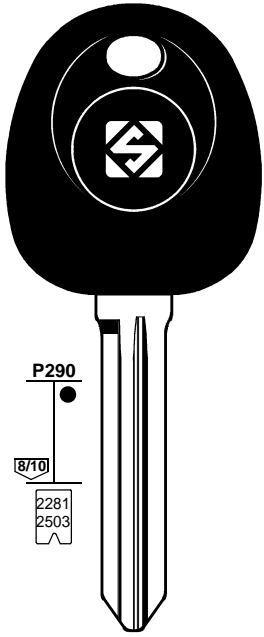

  
**HYN14RT14**  
M . . . . 1-2500  
T . . . . 1-2500  
WC . . . . 1001-3500

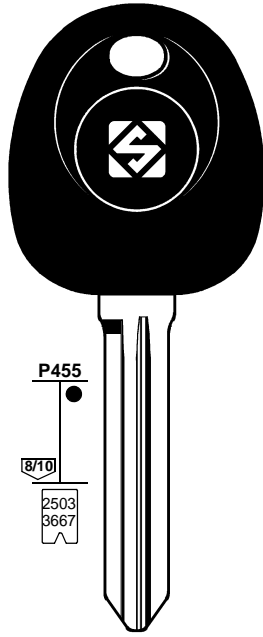

 **TE KEY**  
**HYN14RTE**  
M . . . . 1-2500  
T . . . . 1-2500  
WC . . . . 1001-3500

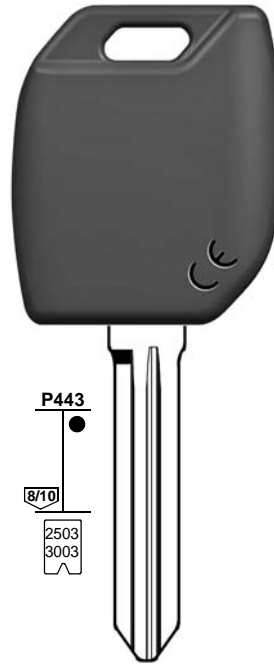

 **MH KEY**  
**HYN14RMH**  
M . . . . 1-2500  
T . . . . 1-2500  
WC . . . . 1001-3500

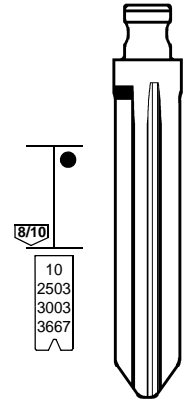

 **FH FLIP**  
**HYN14RFH**  
M . . . . 1-2500  
T . . . . 1-2500  
WC . . . . 1001-3500

FOR:  
PER:

# HYUNDAI

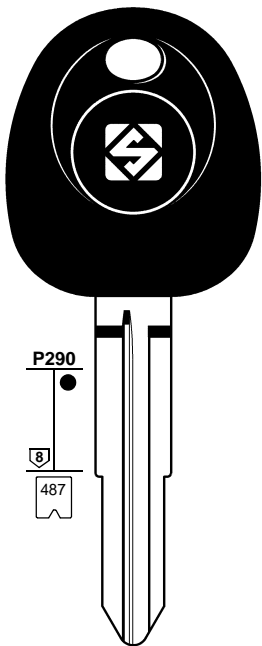

  
**HYN10T4**  
R . . . . 1-1000  
X . . . . 1-1000

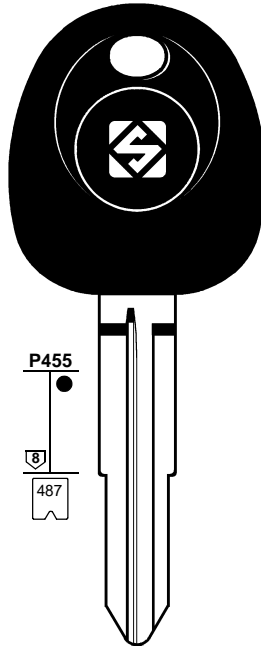

 **TE KEY**  
**HYN10TE**  
R . . . . 1-1000  
K . . . . 1-1000

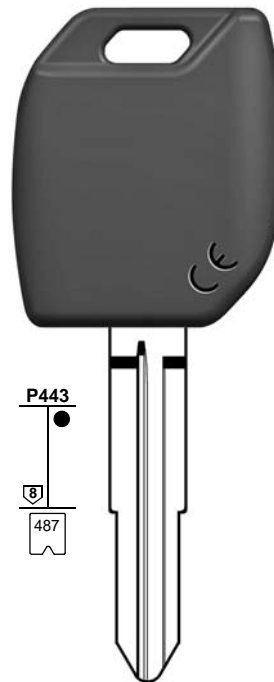

 **MH KEY**  
**HYN10MH**  
X . . . . 1-1000  
R . . . . 1-1000

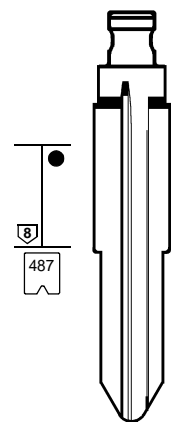

 **FH FLIP**  
**HYN10FH**  
R . . . . 1-1000  
K . . . . 1-1000  
X . . . . 1-1000



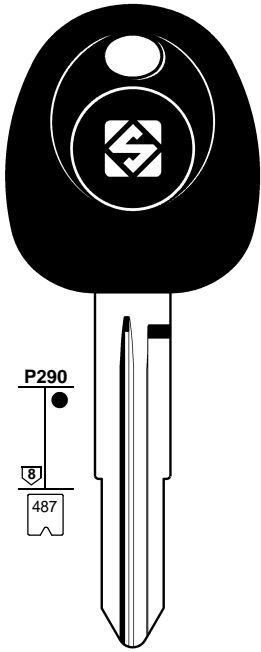

FOR:  
PER:

# HYUNDAI



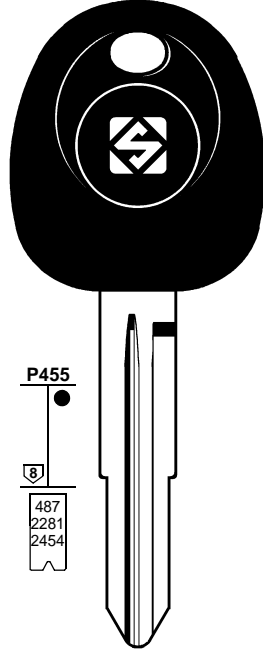

   
**HYN6T14**  
T . . . . 1-1000



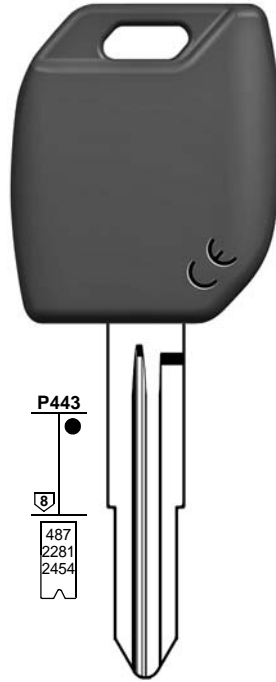

   
**HYN6TE**  
A . . . . 1-1000  
R . . . . 1-1000  
T . . . . 1-1000  
V . . . . 1-1200

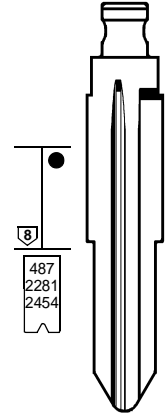

   
**HYN6MH**  
A . . . . 1-1000  
R . . . . 1-1000  
T . . . . 1-1000  
V . . . . 1-1200



   
**HYN6FH**  
A . . . . 1-1000  
R . . . . 1-1000  
T . . . . 1-1000  
V . . . . 1-1200

FOR:  
PER:

# HYUNDAI

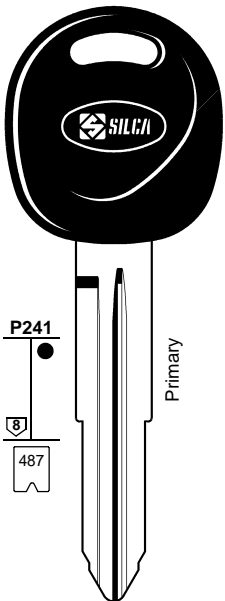

  
**HYN7RAP**  
S . . . . 1-1000

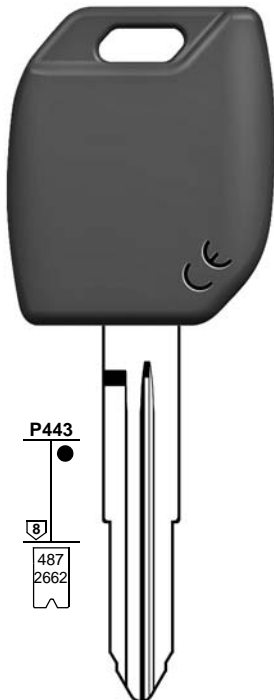

   
**HYN7RMH**  
S . . . . 1-1000

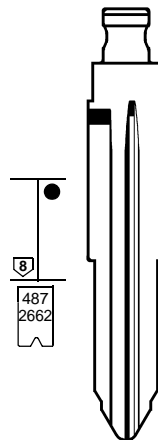

   
**HYN7RFH**  
S . . . . 1-1000

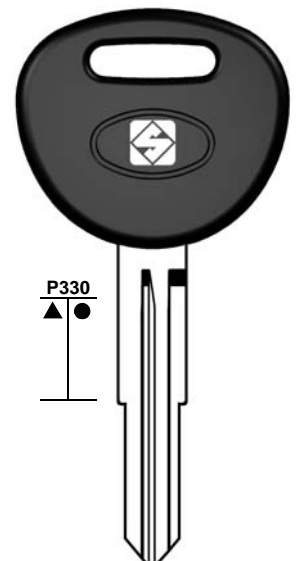

  
**HYN13BP**



FOR:  
PER:

# INFINITI

**P264**  
607

**P443**  
607

607  
3729

**P395**  
607  
Master

**P264**  
145  
607

145

**NSN14T14**  
..... 1-22185

**NSN14MH**  
..... 1-22185  
..... 30001-37850

**NSN14FH**  
..... 1-22185

**NI02T**  
..... 1-22185

**NSN11T2**  
X ..... 1-8000  
..... 1-22185  
..... 30001-37850  
X ..... 8001-9000

**NSN11FH**  
X ..... 1-8000  
X ..... 8001-9000

**NSN14TE**  
..... 1-22185  
..... 30001-37850

FOR:  
PER:

# ISUZU

**889**  
262

262  
514

**772**  
262

**P122**  
264

**P233**  
567  
Primary

**HON58R**  
..... 5001-8442

**HON58RFH**  
..... 5001-8442  
..... 10001-15000

**HON59R**  
..... 5001-8442

**GM19P**  
N ..... 5001-7000  
U ..... 1-2000

**GM39EP**  
..... AA00-7T51  
..... S000A-S711K

1	2	2a	3	3a	3b	e1+e2		6	42+71	72	43+44a	12	15
						<b>GTI COMPATIBLE</b>		<b>IGNITION</b> 					
<b>CAR MAKE MODEL</b>	FROM	TO	SILCA REF.	SILCA REF.	SILCA REF.	COPY	GEN.	TRANSP. TYPE	FAST COPY PLUS RW4 PLUS FAST COPY/RW4	FAST COPY PLUS RW4 PLUS	FAST COPY RW4	STP	
For more info on the uses of car keys, refer to the Silca Electronic Keys Catalogue:													
<b>INFINITI</b>													
EX35	2008	2012	SMARTKEY					PH / CR2	46				
FX35	2003		SMARTKEY					PH / CR2	46				
FX35	2003	2009	NSN14T14					PH / CR2	46				
FX35	2003	2009	NSN14MH	NSN14TE	NSN14FH	Y	Y	PH / CR2	46	Y	P-BOX		
FX45	2003	2009	NSN14T14					PH / CR2	46				
FX45	2003		SMARTKEY					PH / CR2	46				
FX45	2003	2009	NSN14MH	NSN14TE	NSN14FH	Y	Y	PH / CR2	46	Y	P-BOX		
FX50	2009		SMARTKEY					PH / CR2	46				
G20	2000	2002	NI02T					TEX / CR	60				
G20	2000	2002	NSN14MH	NSN14TE	NSN14FH	Y	Y	TEX / CR	60	Y	P-BOX		
G25	2011	2012	SMARTKEY					PH / CR2	46				
G35	2003	2007	NSN14T14					PH / CR2	46				
G35	2003	2007	NSN14MH	NSN14TE	NSN14FH	Y	Y	PH / CR2	46	Y	P-BOX		
G35	2005	2008	SMARTKEY					PH / CR2	46				
G37	2009		SMARTKEY					PH / CR2	46				
IPL G C.PE	2011	2012	SMARTKEY					PH / CR2	46				
I30	1999	2000	NSN11T2		NSN11FH			PH	33	Y	Y	N-N	
I30	2001	2004	NI02T					TEX / CR	60				
I30	2001	2004	NSN14MH	NSN14TE	NSN14FH	Y	Y	TEX / CR	60	Y	P-BOX		
I35	2001	2004	NI02T					TEX / CR	60				
I35	2001	2004	NSN14MH	NSN14TE	NSN14FH	Y	Y	TEX / CR	60	Y	P-BOX		
JX35	2013		SMARTKEY					PH / CR2	46				
M35	2003	2004	NSN14T14					PH / CR2	46				
M35	2003	2004	NSN14MH	NSN14TE	NSN14FH	Y	Y	PH / CR2	46	Y	P-BOX		
M35	2006	2010						PH / CR2	46				
M45	2003	2006	NSN14T14					PH / CR2	46				
M45	2003	2006	NSN14MH	NSN14TE	NSN14FH	Y	Y	PH / CR2	46	Y	P-BOX		
M45	2006	2010						PH / CR2	46				
M56	2011		SMARTKEY					PH / CR2	46				
QX4	1997	1999						TEXAS	4C				
QX4	1997	1999	NSN14MH	NSN14TE	NSN14FH	Y	Y	TEXAS	4C	Y	P-BOX		
QX4	1999	2003	NI02T					TEX / CR	60				
QX4	1999	2003	NSN14MH	NSN14TE	NSN14FH	Y	Y	TEX / CR	60	Y	P-BOX		
QX56	2004	2007	NSN14T14					PH / CR2	46				
QX56	2004	2007	NSN14MH	NSN14TE	NSN14FH	Y	Y	PH / CR2	46	Y	P-BOX		
QX56	2008	2012	SMARTKEY					PH / CR2	46				
Q45	1997	2000						TEXAS	4C				
Q45	1997	2000	NSN14MH	NSN14TE	NSN14FH	Y	Y	TEXAS	4C	Y	P-BOX		
Q45	2001	2005	NSN14T14					PH / CR2	46				
Q45	2001	2005	NSN14MH	NSN14TE	NSN14FH	Y	Y	PH / CR2	46	Y	P-BOX		
<b>ISUZU</b>													
AMIGO	1998	2000	HON58R		HON58RFH								
AMIGO	1998	2000	GM19P										
ASCENDER	2003	2006	GM39EP										
AXIOM	2002	2002	HON59R										
AXIOM	2002	2002	HON58R		HON58RFH								



FOR:  
PER:

# ISUZU

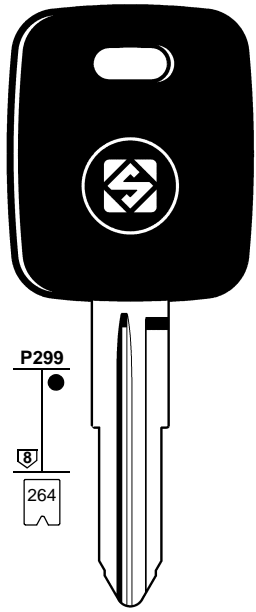

**GM15T5**  
N . . . . 5001-7000

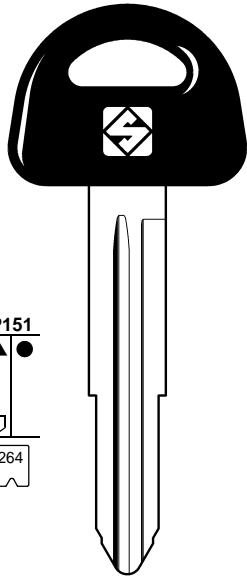

**SZ12P**  
U . . . . 1-2000

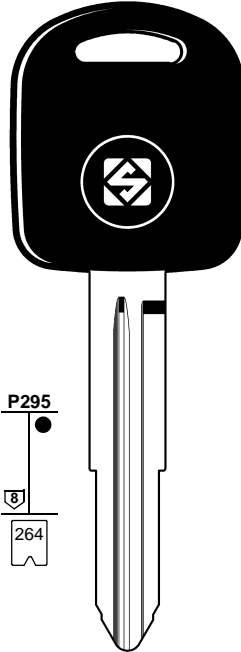

**SZ12TE**  
U . . . . 1-2000

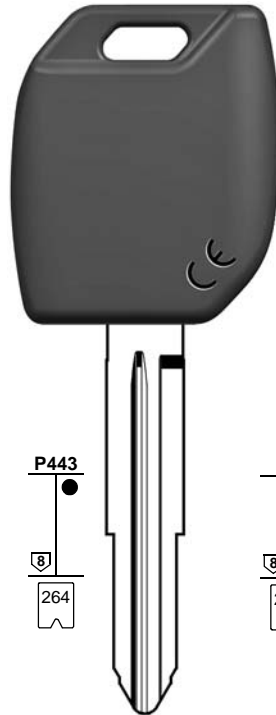

**SZ12MH**  
U . . . . 1-2000

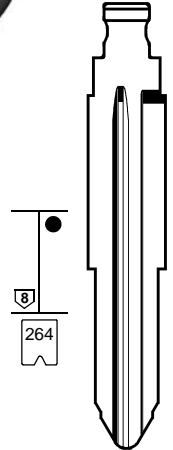

**SZ12FH**  
U . . . . 1-2000

FOR:  
PER:

# ISUZU

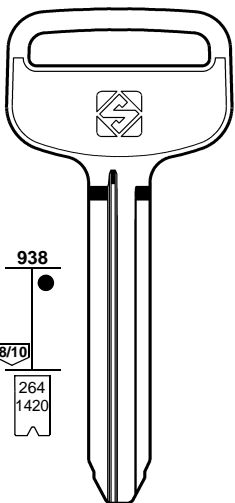

**TOY43R**  
.....  
10001-15000  
50000-59999  
60000-69999  
70000-75928

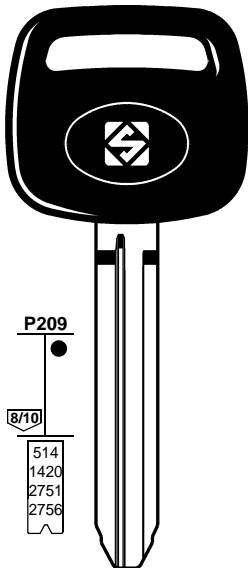

**TOY43RP**  
.....  
10001-15000  
50000-59999  
60000-69999  
70000-75928

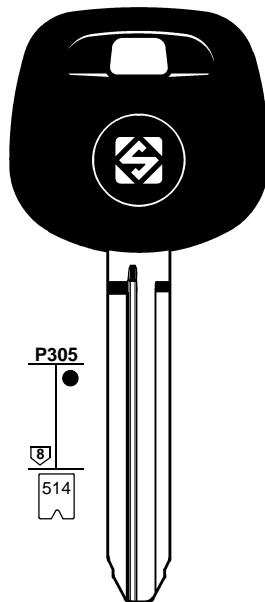

**TOY43RATE**  
.....  
10001-15000  
50000-59999  
60000-69999

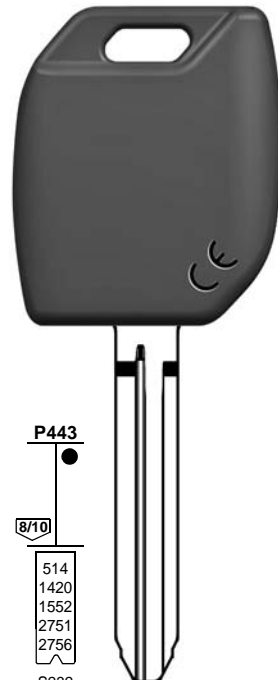

**TOY43RMH**  
..... 10001-15000  
..... 50000-59999  
..... 60000-69999  
..... 25001-26200  
..... 1-5000

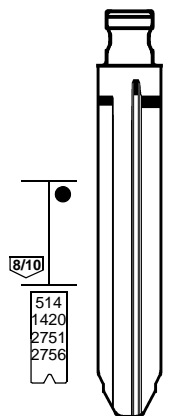

**TOY43RFH**  
..... 1001-15000  
..... 70000-75928



FOR:  
PER:

# IVECO

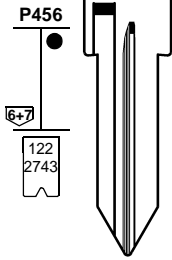

### GT10BTE

- .... 1/9 . . . A/Z/AZ MNPRS
- .... 0/90/9 MNPRS
- .... 1/9 . . . A/Z MNPRS
- .... 1/9 . . . A/Z MNPRS
- .... 1/9 . . . A/Z MNPRS
- .... 1/9 . . . A/Z MNPRS
- .... 1/9 . . . A/Z MNPRS
- .... 1/9 . . . A/Z MNPRS
- .... 3001-4000
- .... 6001-7000

GIOBERT - TRW SIPEA

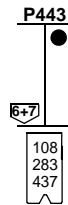

### GT10MH

- J . . . . 3001-6732
- N . . . . 6001-7000
- V . . . . 0001-3056
- V . . . . 5001-8058
- AB . . . . 6001-6891
- .... 3001-4000
- .... 6001-7000

GIOBERT - TRW SIPEA

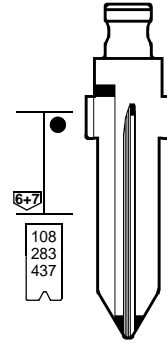

### GT10FH

- J . . . . 3001-6732
- N . . . . 6001-7000
- V . . . . 0001-3056
- V . . . . 5001-8058
- AB . . . . 6001-6891
- .... 3001-4000
- .... 6001-7000

FOR:  
PER:

# IVECO

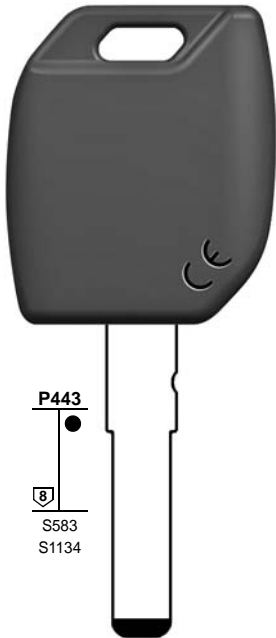

### SIP22MH

- DE . . . . . 1-11210

GIOBERT - TRW SIPEA

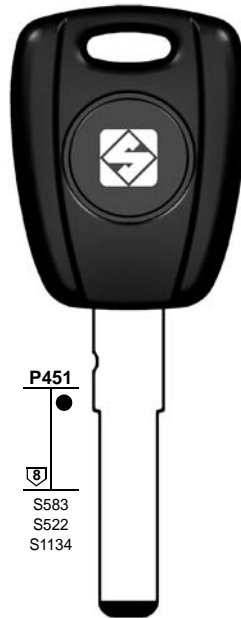

### SIP22TE

- DE . . . . . 1-11210

GIOBERT - TRW SIPEA

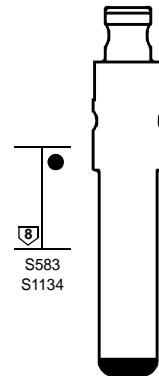

### SIP22FH

- DE . . . . . 1-11210



FOR:  
PER:

# JAGUAR

# JDM (MICROCARS)

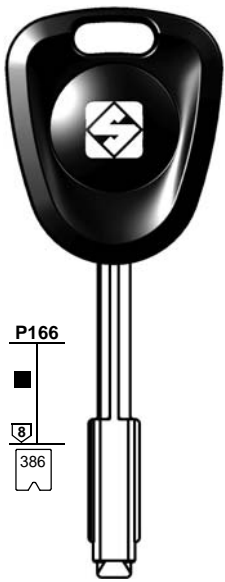

P166  
8  
386

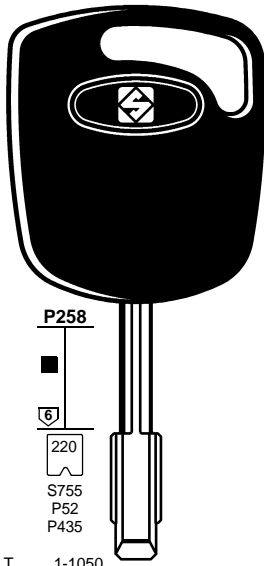

P258  
6  
220  
S755  
P52  
P435

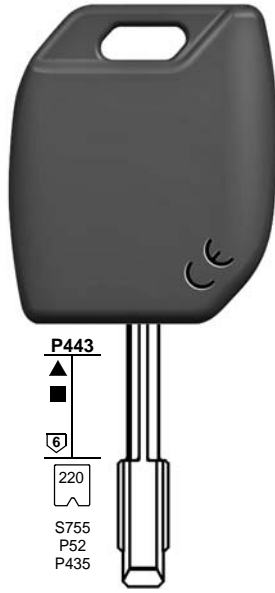

P443  
6  
220  
S755  
P52  
P435



6  
220  
S755  
P52  
P435

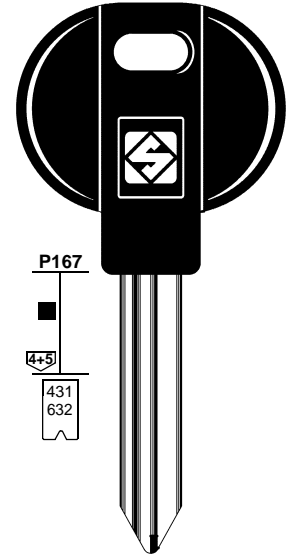

P167  
4+5  
431  
632

T.... 1-1050  
T.... 1-2330  
T.... 1051-2330  
T..... 1-2-3-4



**TBE1T5**  
T..... 1-2-3



**FO21TE**



**FO21MH**  
T.... 1-1050  
T.... 1-2330  
T.... 1051-2330  
T..... 1-2-3-4



**FO21FH**  
T.... 1-1050  
T.... 1-2330  
T.... 1051-2330  
T..... 1-2-3-4



**SX9AP**  
63/99 ..... H 12468  
63/99 ..... 12468  
..... H 0111111-6288888  
..... 0111111-6288888

VALEO

TIBBE - VALEO

TIBBE - VALEO

FOR:  
PER:

# JEEP

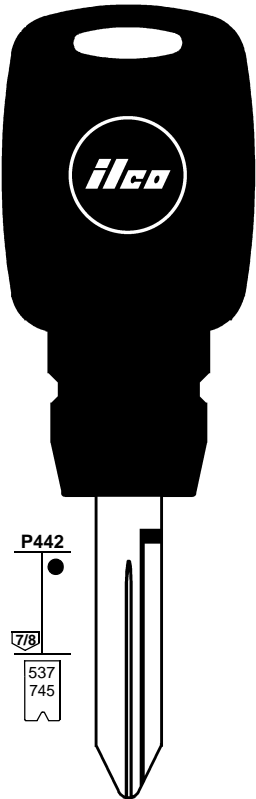

P442  
7/8  
537  
745

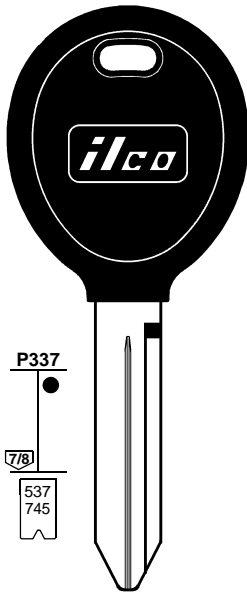

P337  
7/8  
537  
745

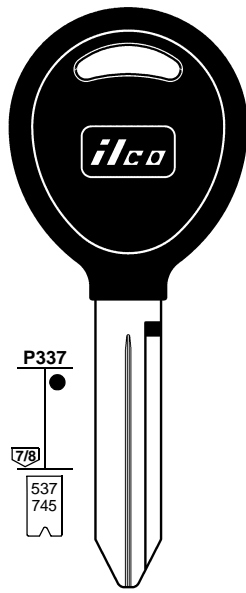

P337  
7/8  
537  
745

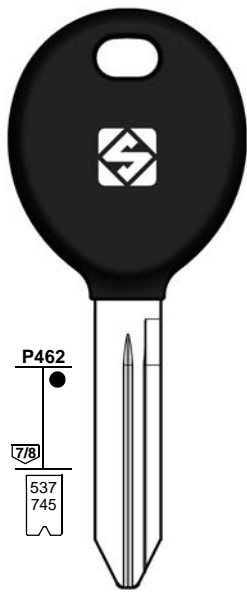

P462  
7/8  
537  
745

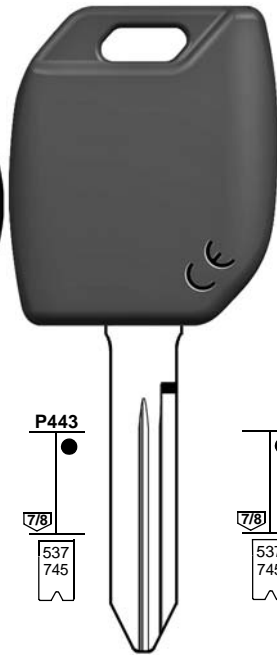

P443  
7/8  
537  
745

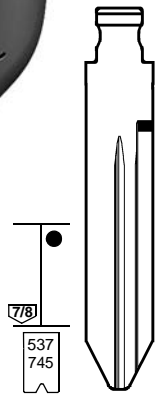

7/8  
537  
745



**EK3P-Y170**  
L.... 1-3580  
M.... 1-2618

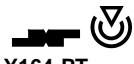

**Y164-PT**  
L.... 1-3580  
M.... 1-2618

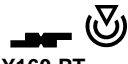

**Y160-PT**  
L.... 1-3580  
M.... 1-2618



**CY24TE**  
L.... 1-3580  
M.... 1-2618



**CY24MH**  
L.... 1-3580  
M.... 1-2618



**CY24FH**  
L.... 1-3580  
M.... 1-2618  
FT.... 1001-3000

MITSUBISHI

1	2	2a	3	3a	3b	e1+e2		6	42+71	72	43+44a	12	15
						<b>GTI COMPATIBLE</b>		<b>IGNITION</b> 					
<b>CAR MAKE MODEL</b>	FROM	TO	SILCA REF.	SILCA REF.	SILCA REF.	COPY	GEN.	TRANSP. TYPE	FAST COPY PLUS RW4 PLUS FAST COPY/RW4	FAST COPY PLUS RW4 PLUS	FAST COPY RW4	STP	
For more info on the uses of car keys, refer to the Silca Electronic Keys Catalogue:													
<b>JAGUAR</b>													
SOVEREIGN	1996	2000	TBE1T5					MEG	13	Y	Y	Meg	
S-TYPE	2000	2008	FO21T7					TEX / CR	60				
S-TYPE	2000	2008	FO21MH	FO21TE	FO21FH	Y	Y	TEX / CR	60	Y	P-BOX		
XJ	2003	2007	FO21T7					TEX / CR	60				
XJ	2003	2007	FO21MH	FO21TE	FO21FH	Y	Y	TEX / CR	60	Y	P-BOX		
XJ , XJS , XK8	1998	1999	TBE1T5					MEG	13	Y	Y	Meg	
XJ , XK	2000	2003						MEG	13				
X-TYPE	2002	2008						TEX / CR	60				
X-TYPE	2002	2008	FO21MH	FO21TE	FO21FH	Y	Y	TEX / CR	60	Y	P-BOX		
<b>JDM (MICROCARS)</b>													
ABACA	2005	2012	SX9AP										
ALBIZIA	2003	2012	SX9AP										
ALOES	2008	2012	SX9AP										
ROSDY	2012		SX9AP										
<b>JEEP</b>													
CHEROKEE	1998	2004	Y160-PT					TEX / CR	64				F
CHEROKEE	1998	2004	CY24MH	CY24TE	CY24FH	Y	Y	TEX / CR	64	Y	P-BOX		
CHEROKEE	2005		Y164-PT					PH / CR2	46				
CHEROKEE	2005		CY24MH	CY24TE	CY24FH	Y	Y	PH / CR2	46	Y	P-BOX		
CHEROKEE LIMITED	1999	2005	Y160-PT					TEX / CR	64				F
CHEROKEE LIMITED	1999	2005	CY24MH	CY24TE	CY24FH	Y	Y	TEX / CR	64	Y	P-BOX		
CJ5,CJ7	1998	2005	Y160-PT					TEX / CR	64				F
CJ5,CJ7	1998	2005	CY24MH	CY24TE	CY24FH	Y	Y	TEX / CR	64	Y	P-BOX		
CJ5,CJ7	2006		Y164-PT					PH / CR2	46				F
CJ5,CJ7	2006		CY24MH	CY24TE	CY24FH	Y	Y	PH / CR2	46	Y	P-BOX		
COMANCHE	2006		Y164-PT					PH / CR2	46				F
COMANCHE	2006		CY24MH	CY24TE	CY24FH	Y	Y	PH / CR2	46	Y	P-BOX		
COMMANDER	2006	2008	Y164-PT					PH / CR2	46				F
COMMANDER	2006	2008	CY24MH	CY24TE	CY24FH	Y	Y	PH / CR2	46	Y	P-BOX		
COMMANDER	2008	2010						PH / CR2	46				
COMMANDER	2008	2010	EK3P-Y170					PH / CR2	46	Y	P-BOX		
COMPASS	2007		Y164-PT					PH / CR2	46				F
COMPASS	2007		CY24MH	CY24TE	CY24FH	Y	Y	PH / CR2	46	Y	P-BOX		
G. CHEROKEE	2005	2008	Y164-PT					PH / CR2	46				F
G. CHEROKEE	2005	2008	CY24MH	CY24TE	CY24FH	Y	Y	PH / CR2	46	Y	P-BOX		
G. CHEROKEE	2008							PH / CR2	46				
G. CHEROKEE	2008		EK3P-Y170					PH / CR2	46	Y	P-BOX		
G.CHEROKEE LUX	1999	2005	Y160-PT					TEX / CR	64				F
G.CHEROKEE LUX	1999	2005	CY24MH	CY24TE	CY24FH	Y	Y	TEX / CR	64	Y	P-BOX		
G.CHEROKEE SPORT	1998	2004	Y160-PT					TEX / CR	64				F
G.CHEROKEE SPORT	1998	2004	CY24MH	CY24TE	CY24FH	Y	Y	TEX / CR	64	Y	P-BOX		
LIBERTY	2002	2004	Y160-PT					TEX / CR	64				F
LIBERTY	2002	2004	CY24MH	CY24TE	CY24FH	Y	Y	TEX / CR	64	Y	P-BOX		
LIBERTY	2005		Y164-PT					PH / CR2	46				
LIBERTY	2005		CY24MH	CY24TE	CY24FH	Y	Y	PH / CR2	46	Y	P-BOX		
PATRIOT	2007		Y164-PT					PH / CR2	46				F
PATRIOT	2007		CY24MH	CY24TE	CY24FH	Y	Y	PH / CR2	46	Y	P-BOX		
WRANGLER	1998	2006	Y160-PT					TEX / CR	64				F
WRANGLER	1998	2006	CY24MH	CY24TE	CY24FH	Y	Y	TEX / CR	64	Y	P-BOX		
WRANGLER	2006		CY24MH	CY24TE	CY24FH	Y	Y	PH / CR2	46	Y	P-BOX		
WRANGLER	2007		Y164-PT					PH / CR2	46				F

FOR:  
PER:

# KIA

**P322**  
S819  
S853  
S1001  
S1122  
S1150

**P443**  
480  
S24  
S232  
S765  
S819  
S853  
S1001  
S1122  
S1150  
S1356

**P472**  
S1001  
S1122

**P443**  
S1001  
S1122

**P443**  
S1001  
S1122  
S853

**KIA7T14**  
G . . . . 0001-2500  
J . . . . 0001-2500  
K . . . . 0001-2500  
L . . . . 0001-1000  
P . . . . 0001-2500

**TOY40MH**  
... 1-5000  
L . . . . 0001-1000  
G . . . . 0001-2500  
J . . . . 0001-2500  
K . . . . 0001-2500  
P . . . . 0001-2500  
... 30001-31200

**TOY40FH**  
... 1-5000  
L . . . . 0001-1000  
J . . . . 0001-2500

**TOY49TE**  
K . . . . 0001-2500  
P . . . . 0001-2500

**TOY49MH**  
K . . . . 0001-2500  
P . . . . 0001-2500

**TOY49FH**  
K . . . . 0001-2500  
P . . . . 0001-2500  
L . . . . 0001-1000

FOR:  
PER:

# KIA

**1136**  
742

**P320**  
742

**P463**  
742

**P443**  
742

**P443**  
742

**P142**  
158

**KIA3R**  
Y . . . . 2001-3000

**KIA3RT16**  
Y . . . . 2001-3000

**KIA3RTE**  
Y . . . . 2001-3000

**KIA3RMH**  
Y . . . . 2001-3000

**KIA3RFH**  
Y . . . . 2001-3000

**KIA4RBP**  
... 5001-6200

**KIA3RT14**  
Y . . . . 2001-3000





FOR:  
PER:

# KIA

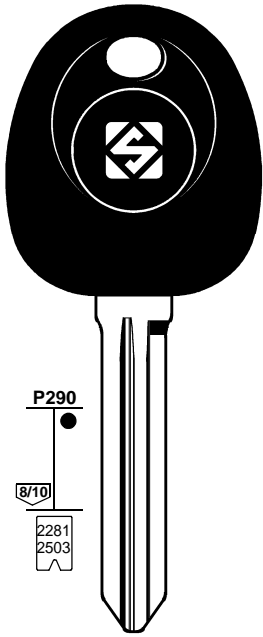

**HYN14T14**

H . . . . 0001-2500  
M . . . . 0001-2500  
P . . . . 0001-2500  
T . . . . 0001-2500  
V . . . . 1-2500

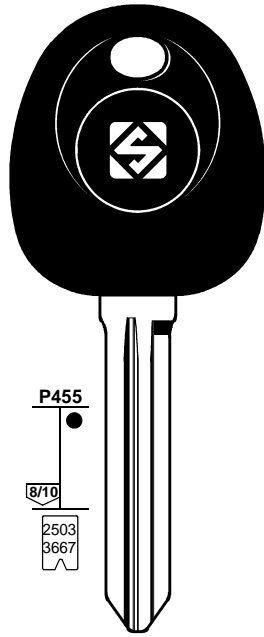

**HYN14TE**

H . . . . 0001-2500  
M . . . . 0001-2500  
P . . . . 0001-2500  
T . . . . 0001-2500  
V . . . . 1-2500



**HYN14MH**

H . . . . 0001-2500  
M . . . . 0001-2500  
P . . . . 0001-2500  
T . . . . 0001-2500  
V . . . . 0001-2500

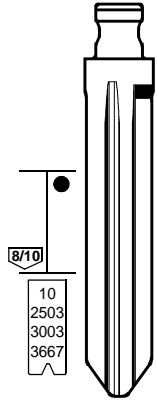

**HYN14FH**

H . . . . 0001-2500  
M . . . . 0001-2500  
P . . . . 0001-2500  
T . . . . 0001-2500  
V . . . . 0001-2500

FOR:  
PER:

# KIA

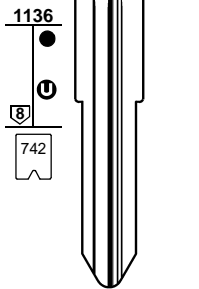
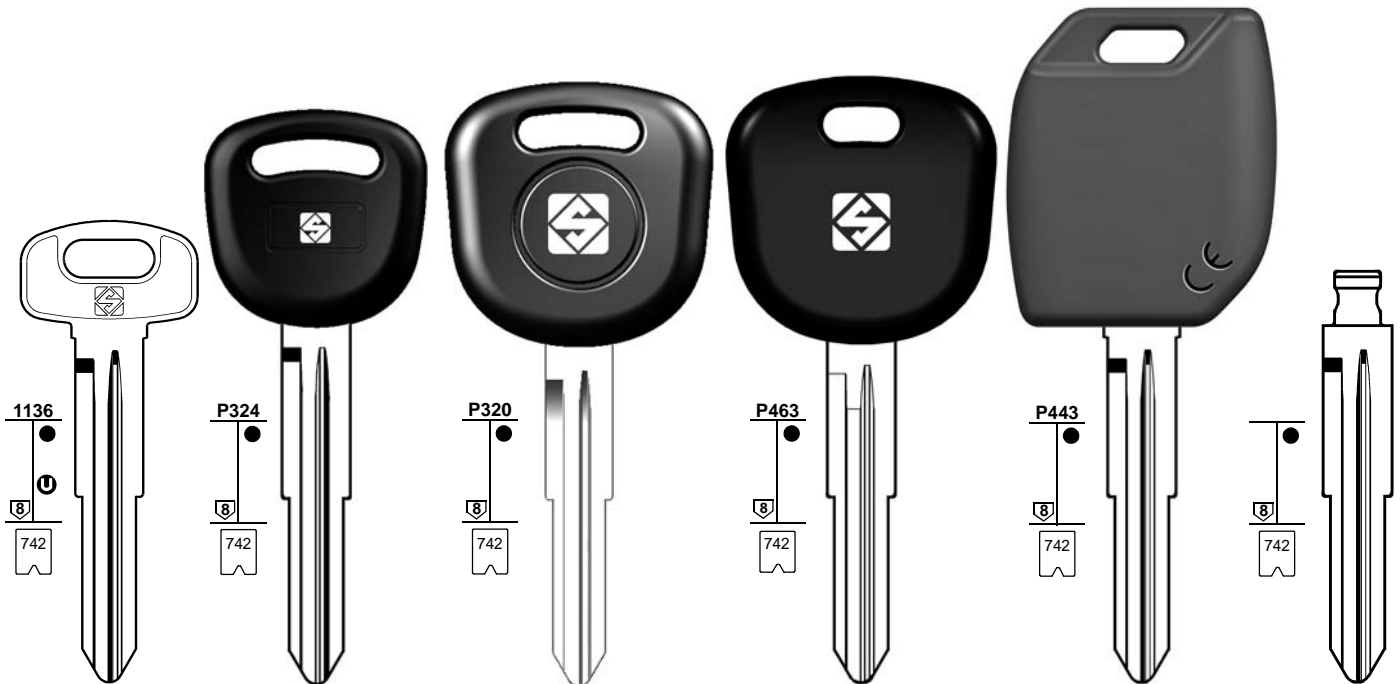

**KIA3R**

Y . . . . 2001-3000

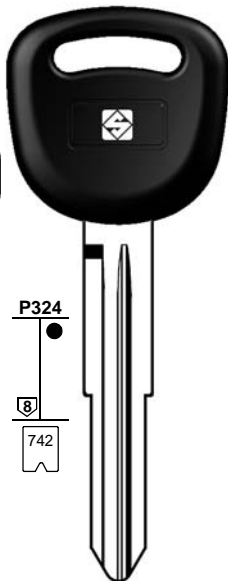

**KIA3RAP**

Y . . . . 2001-3000

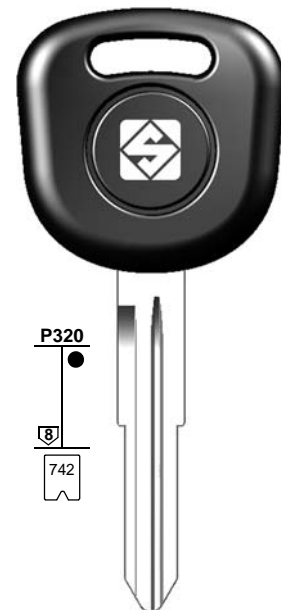

**KIA3RT14**

Y . . . . 2001-3000

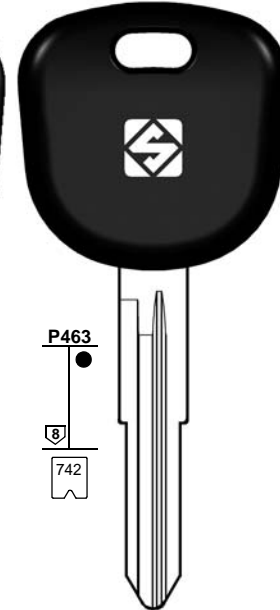

**KIA3RT16**

Y . . . . 2001-3000

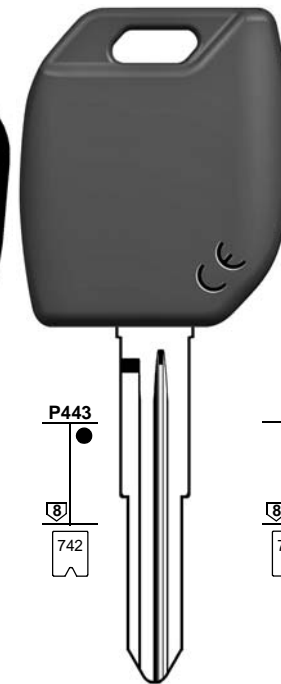

**KIA3RTE**

Y . . . . 2001-3000

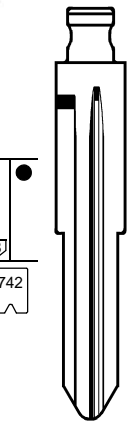

**KIA3RMH**

Y . . . . 2001-3000



**KIA3RFH**

Y . . . . 2001-3000



FOR:  
PER:

# KIA

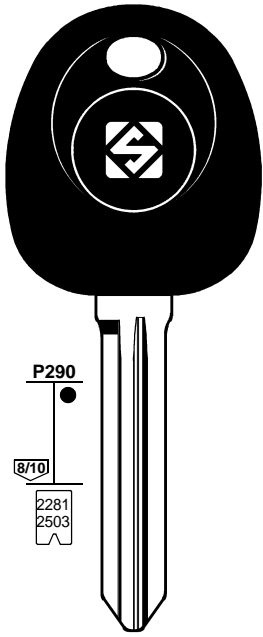

**HYN14RT14**  
M . . . . 1-2500  
T . . . . 1-2500  
WC . . . . 1001-3500

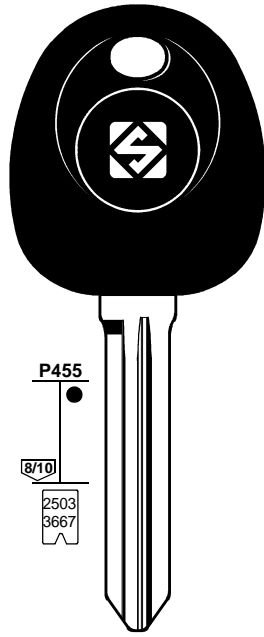

**HYN14RTE**  
M . . . . 1-2500  
T . . . . 1-2500  
WC . . . . 1001-3500

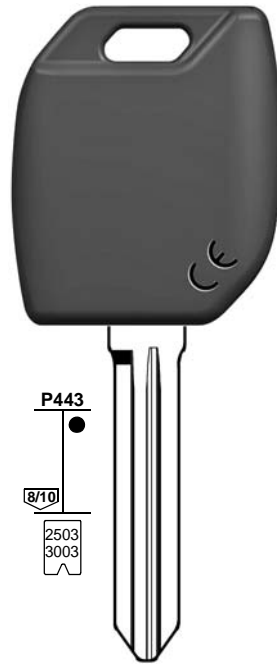

**HYN14RMH**  
M . . . . 1-2500  
T . . . . 1-2500  
WC . . . . 1001-3500

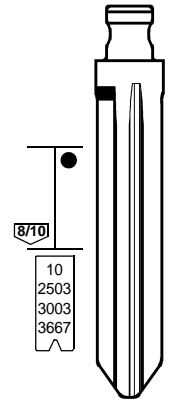

**HYN14RFH**  
M . . . . 1-2500  
T . . . . 1-2500  
WC . . . . 1001-3500

FOR:  
PER:

# KIA

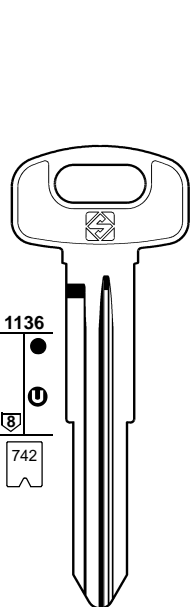

**KIA3R**  
Y . . . . 2001-3000

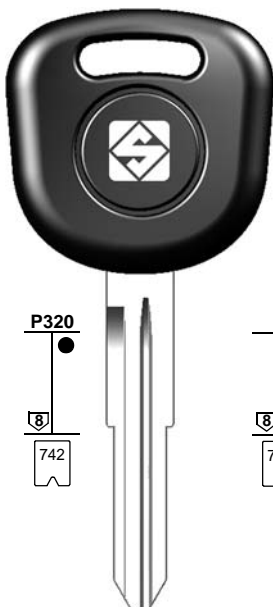

**KIA3RT5**  
Y . . . . 2001-3000

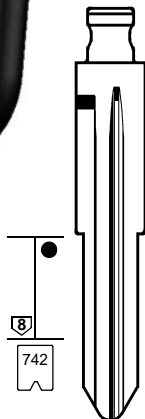

**KIA3RFH**  
Y . . . . 2001-3000

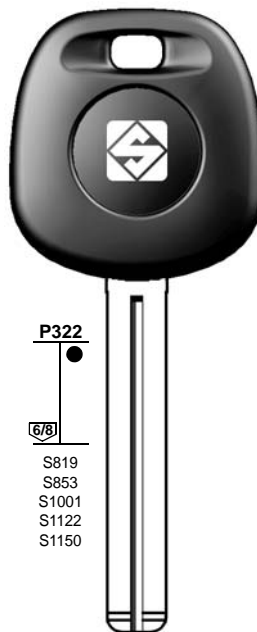

**KIA7T14**  
G . . . . 0001-2500  
J . . . . 0001-2500  
K . . . . 0001-2500  
L . . . . 0001-1000  
P . . . . 0001-2500

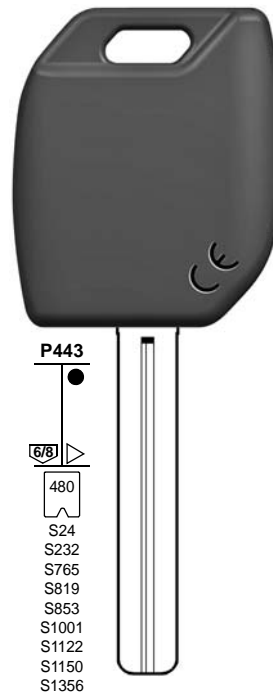

**TOY40MH**  
. . . . 1-5000  
L . . . . 0001-1000  
G . . . . 0001-2500  
J . . . . 0001-2500  
K . . . . 0001-2500  
P . . . . 0001-2500  
. . . . 30001-31200

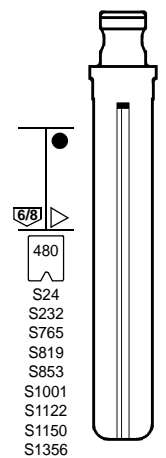

**TOY40FH**  
. . . . 1-5000  
L . . . . 0001-1000  
J . . . . 0001-2500



FOR:  
PER:

# KIA

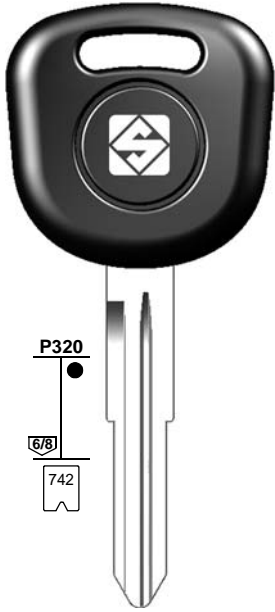

   
**KIA3RT14**  
Y . . . . 2001-3000

   
**KIA3RT16**  
Y . . . . 2001-3000

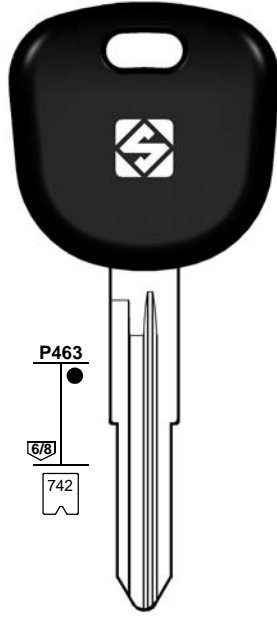

   
**KIA3RTE**  
Y . . . . 2001-3000



   
**KIA3RMH**  
Y . . . . 2001-3000

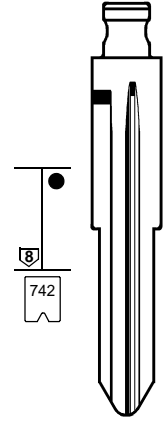



   
**KIA3RFH**  
Y . . . . 2001-3000

FOR:  
PER:

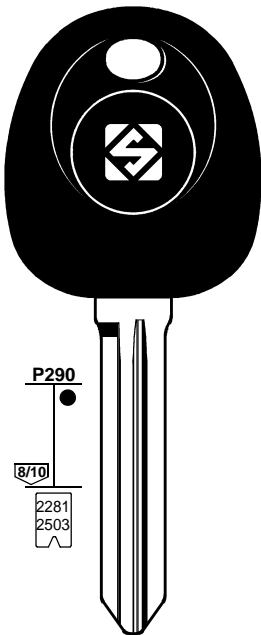
# KIA



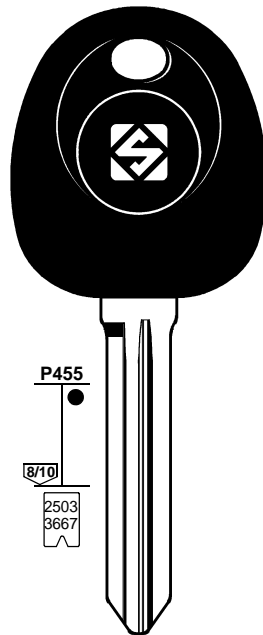

   
**HYN14RT14**  
M . . . . 1-2500  
T . . . . 1-2500  
WC . . . . 1001-3500



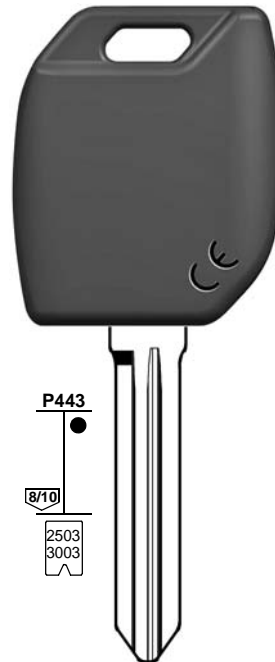

   
**HYN14RTE**  
M . . . . 1-2500  
T . . . . 1-2500  
WC . . . . 1001-3500

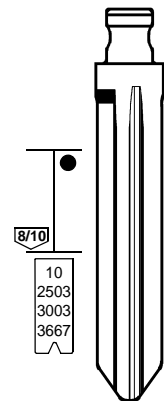

   
**HYN14RMH**  
M . . . . 1-2500  
T . . . . 1-2500  
WC . . . . 1001-3500



   
**HYN14RFH**  
M . . . . 1-2500  
T . . . . 1-2500  
WC . . . . 1001-3500



FOR:  
PER:

# KIA

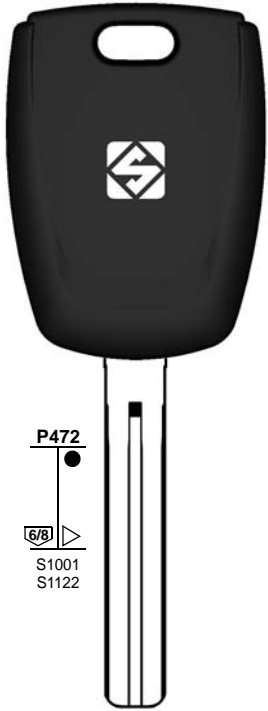

P472  
6/8  
S1001  
S1122



**TOY49TE**

K . . . . 0001-2500  
P . . . . 0001-2500

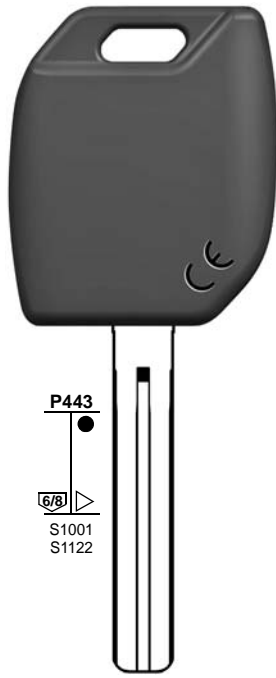

P443  
6/8  
S1001  
S1122



**TOY49MH**

K . . . . 0001-2500  
P . . . . 0001-2500

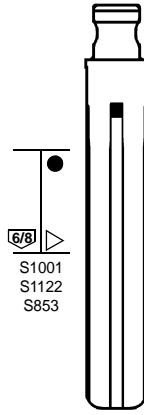

6/8  
S1001  
S1122  
S853



**TOY49FH**

K . . . . 0001-2500  
P . . . . 0001-2500  
L . . . . 0001-1000

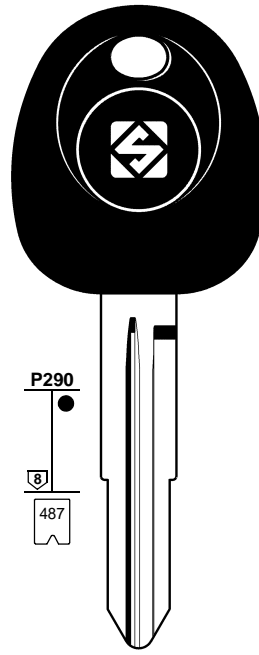

P290  
8  
487



**HYN6T14**

T . . . . 1-1000

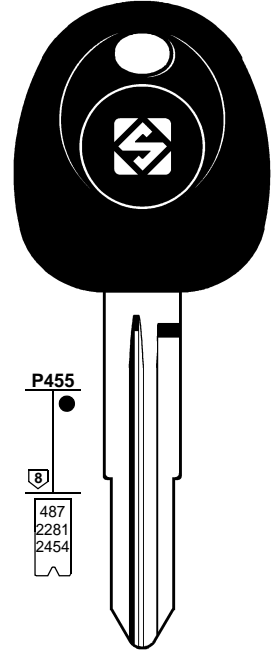

P455  
8  
487  
2281  
2454



**HYN6TE**

A . . . . 1-1000  
R . . . . 1-1000  
T . . . . 1-1000  
V . . . . 1-1200

FOR:  
PER:

# KIA

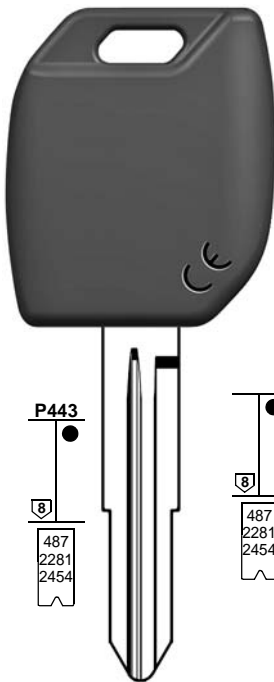

P443  
8  
487  
2281  
2454



**HYN6MH**

A . . . . 1-1000  
R . . . . 1-1000  
T . . . . 1-1000  
V . . . . 1-1200

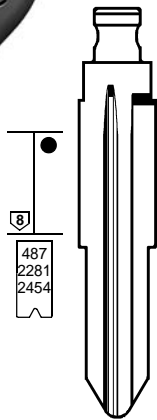

8  
487  
2281  
2454



**HYN6FH**

A . . . . 1-1000  
R . . . . 1-1000  
T . . . . 1-1000  
V . . . . 1-1200

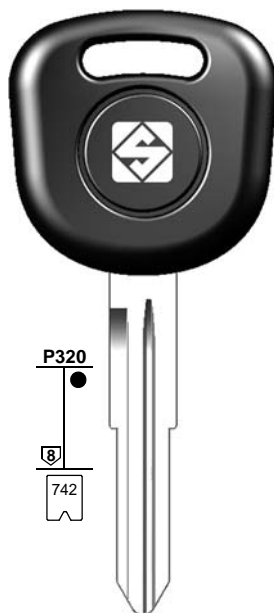

P320  
8  
742



**KIA3RT14**

Y . . . . 2001-3000

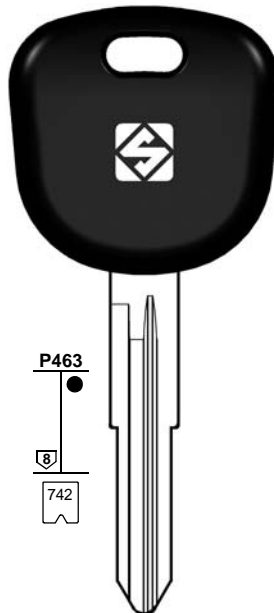

P463  
8  
742



**KIA3RTE**

Y . . . . 2001-3000



P443  
8  
742



**KIA3RMH**

Y . . . . 2001-3000

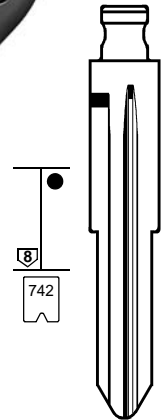

8  
742



**KIA3RFH**

Y . . . . 2001-3000





FOR:  
PER:

# KIA



P443

6/8

480

S24  
S232  
S765  
S819  
S853  
S1001  
S1122  
S1150  
S1356



**TOY40MH**

... 1-5000  
L ... 0001-1000  
G ... 0001-2500  
J ... 0001-2500  
K ... 0001-2500  
P ... 0001-2500  
... 30001-31200

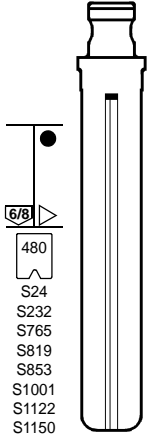

6/8

480

S24  
S232  
S765  
S819  
S853  
S1001  
S1122  
S1150  
S1356



**TOY40FH**

... 1-5000  
L ... 0001-1000  
J ... 0001-2500



P472

6/8

S1001  
S1122



**TOY49TE**

K ... 0001-2500  
P ... 0001-2500



P443

6/8

S1001  
S1122



**TOY49MH**

K ... 0001-2500  
P ... 0001-2500

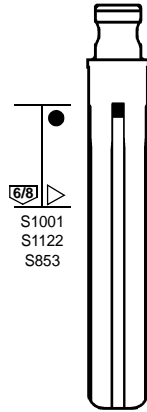

6/8

S1001  
S1122  
S853



**TOY49FH**

FOR:  
PER:

# KIA



P320

8

742



**KIA3RT14**

Y ... 2001-3000



P463

8

742



**KIA3RTE**

Y ... 2001-3000



P443

8

742



**KIA3RMH**

Y ... 2001-3000

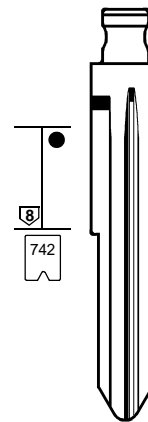

8

742



**KIA3RFH**

Y ... 2001-3000



FOR:  
PER:

# KIA

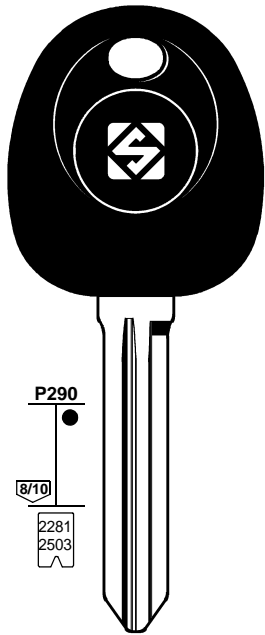

**HYN14T14**

H . . . . 0001-2500  
 M . . . . 0001-2500  
 P . . . . 0001-2500  
 T . . . . 0001-2500  
 V . . . . 1-2500

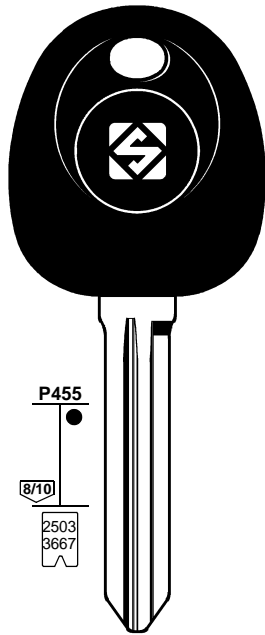

**HYN14TE**

H . . . . 0001-2500  
 M . . . . 0001-2500  
 P . . . . 0001-2500  
 T . . . . 0001-2500  
 V . . . . 1-2500

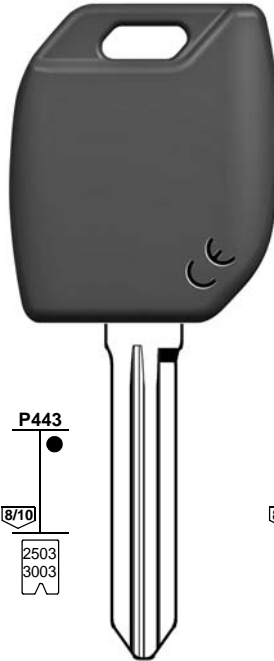

**HYN14MH**

H . . . . 0001-2500  
 M . . . . 0001-2500  
 P . . . . 0001-2500  
 T . . . . 0001-2500  
 V . . . . 0001-2500

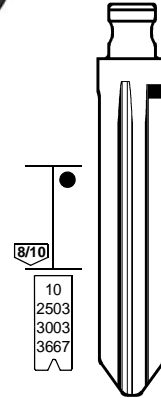

**HYN14FH**

H . . . . 0001-2500  
 M . . . . 0001-2500  
 P . . . . 0001-2500  
 T . . . . 0001-2500  
 V . . . . 0001-2500

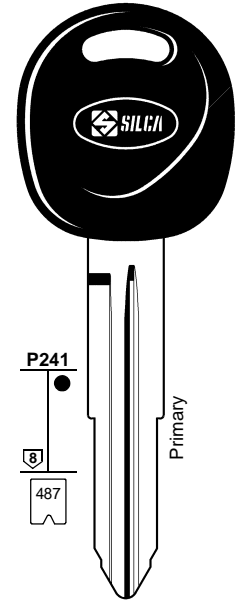

**HYN7RAP**

S . . . . 1-1000

FOR:  
PER:

# KIA

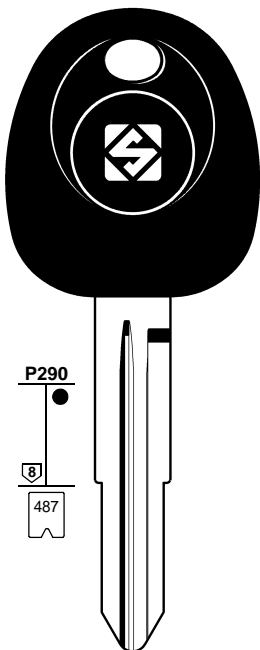

**HYN6T14**

T . . . . 1-1000

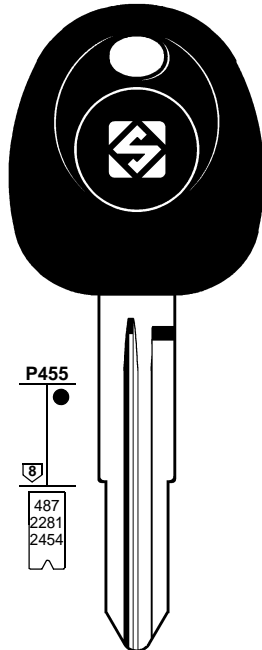

**HYN6TE**

A . . . . 1-1000  
 R . . . . 1-1000  
 T . . . . 1-1000  
 V . . . . 1-1200

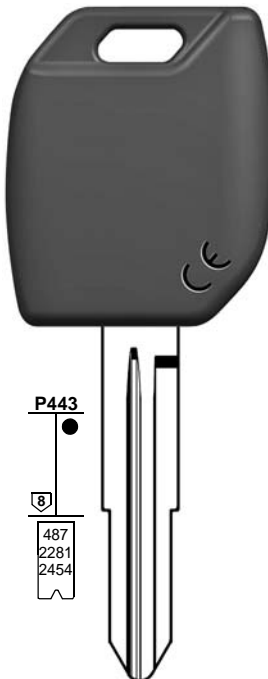

**HYN6MH**

A . . . . 1-1000  
 R . . . . 1-1000  
 T . . . . 1-1000  
 V . . . . 1-1200

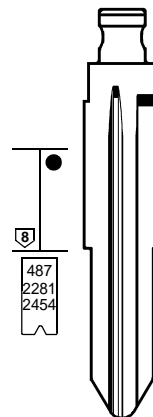

**HYN6FH**

A . . . . 1-1000  
 R . . . . 1-1000  
 T . . . . 1-1000  
 V . . . . 1-1200



**KIA7T14**

G . . . . 0001-2500  
 J . . . . 0001-2500  
 K . . . . 0001-2500  
 L . . . . 0001-1000  
 P . . . . 0001-2500



FOR:  
PER:

# KIA

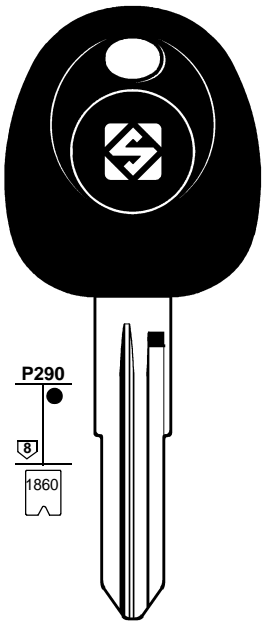

P290  
1860



**HYN15T14**

WA . . . . 1001-3040

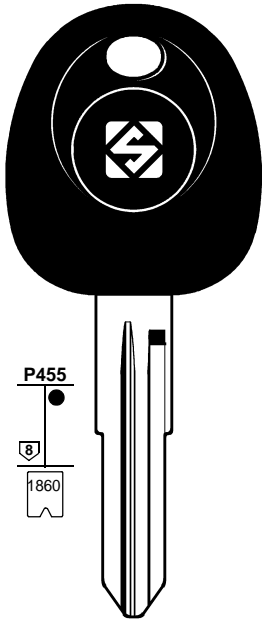

P455  
1860



**HYN15TE**

WA . . . . 1001-3040

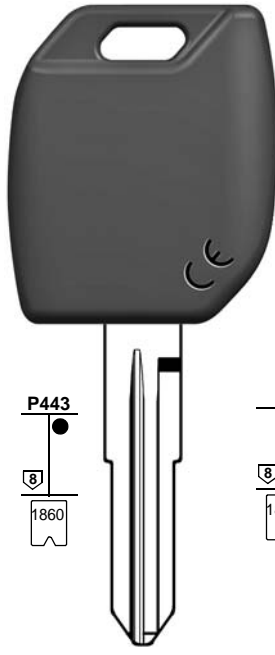

P443  
1860



**HYN15MH**

WA . . . . 1001-3040

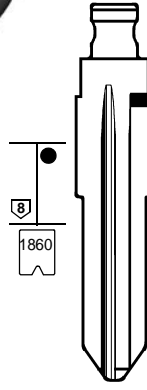

1860



**HYN15FH**

WA . . . . 1001-3040

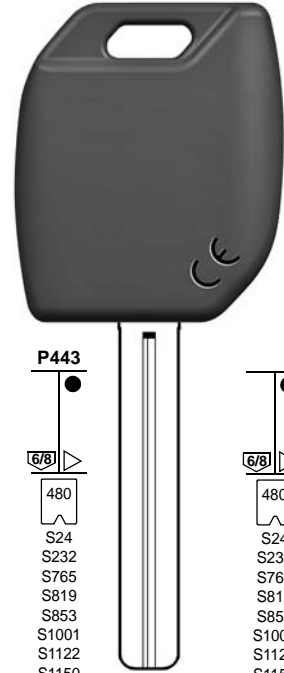

P443  
480  
S24  
S232  
S765  
S819  
S853  
S1001  
S1122  
S1150  
S1356



**TOY40MH**

. . . . 1-5000  
L . . . . 0001-1000  
G . . . . 0001-2500  
J . . . . 0001-2500  
K . . . . 0001-2500  
P . . . . 0001-2500  
. . . . 30001-31200

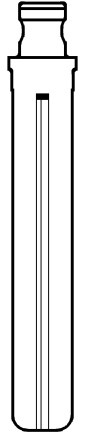

480  
S24  
S232  
S765  
S819  
S853  
S1001  
S1122  
S1150  
S1356



**TOY40FH**

. . . . 1-5000  
L . . . . 0001-1000  
J . . . . 0001-2500

FOR:  
PER:

# KIA

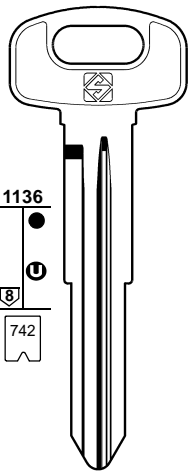

1136  
742

**KIA3R**

Y . . . . 2001-3000

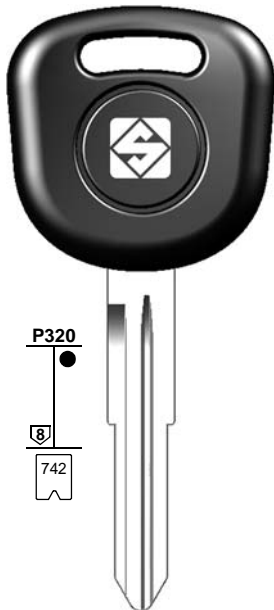

P320  
742



**KIA3RT16**

Y . . . . 2001-3000

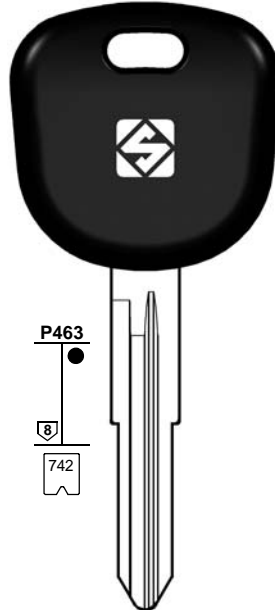

P463  
742



**KIA3RTE**

Y . . . . 2001-3000

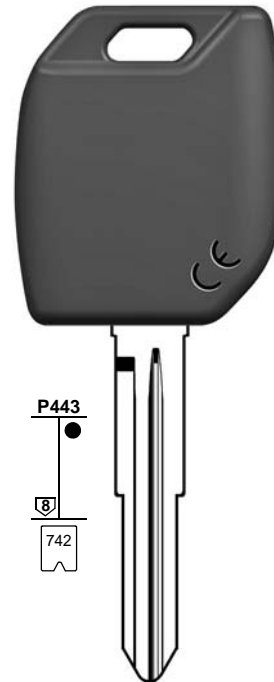

P443  
742



**KIA3RMH**

Y . . . . 2001-3000

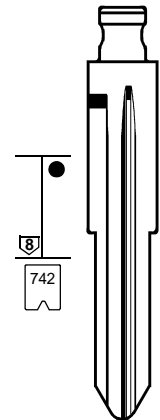

742



**KIA3RFH**

Y . . . . 2001-3000



FOR:  
PER:

# KIA

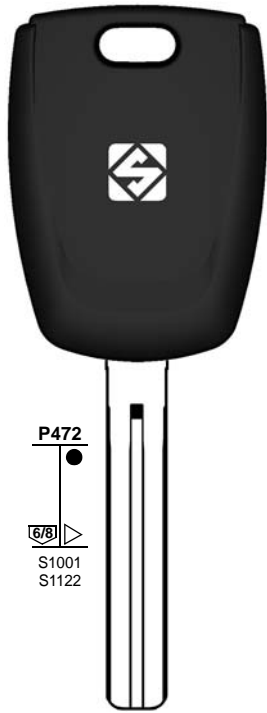

P472  
6/8  
S1001  
S1122



**TOY49TE**

K . . . . 0001-2500  
P . . . . 0001-2500

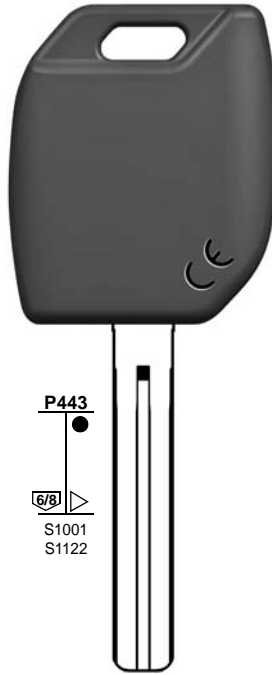

P443  
6/8  
S1001  
S1122



**TOY49MH**

K . . . . 0001-2500  
P . . . . 0001-2500

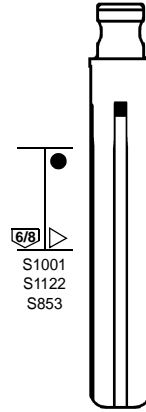

P472  
6/8  
S1001  
S1122  
S853



**TOY49FH**

K . . . . 0001-2500  
P . . . . 0001-2500  
L . . . . 0001-1000

FOR:  
PER:

# KIA

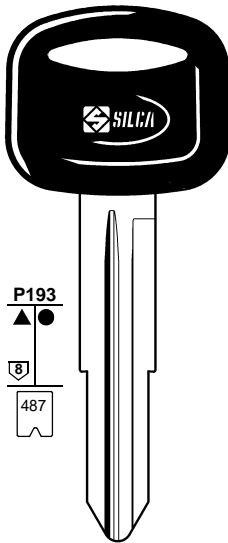

P193  
8  
487



**HYN6P**

T . . . . 1-1000

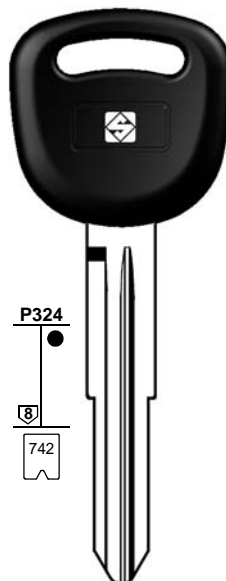

P324  
8  
742



**KIA3RAP**

Y . . . . 2001-3000

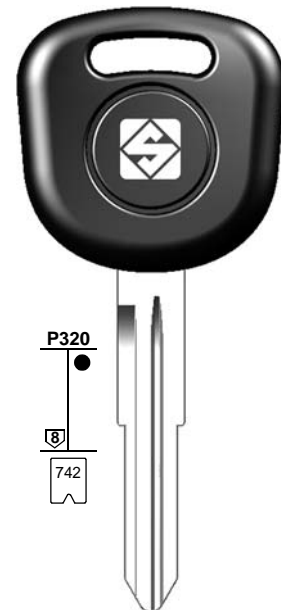

P320  
8  
742



**KIA3RT16**

Y . . . . 2001-3000





FOR:  
PER:

# KIA

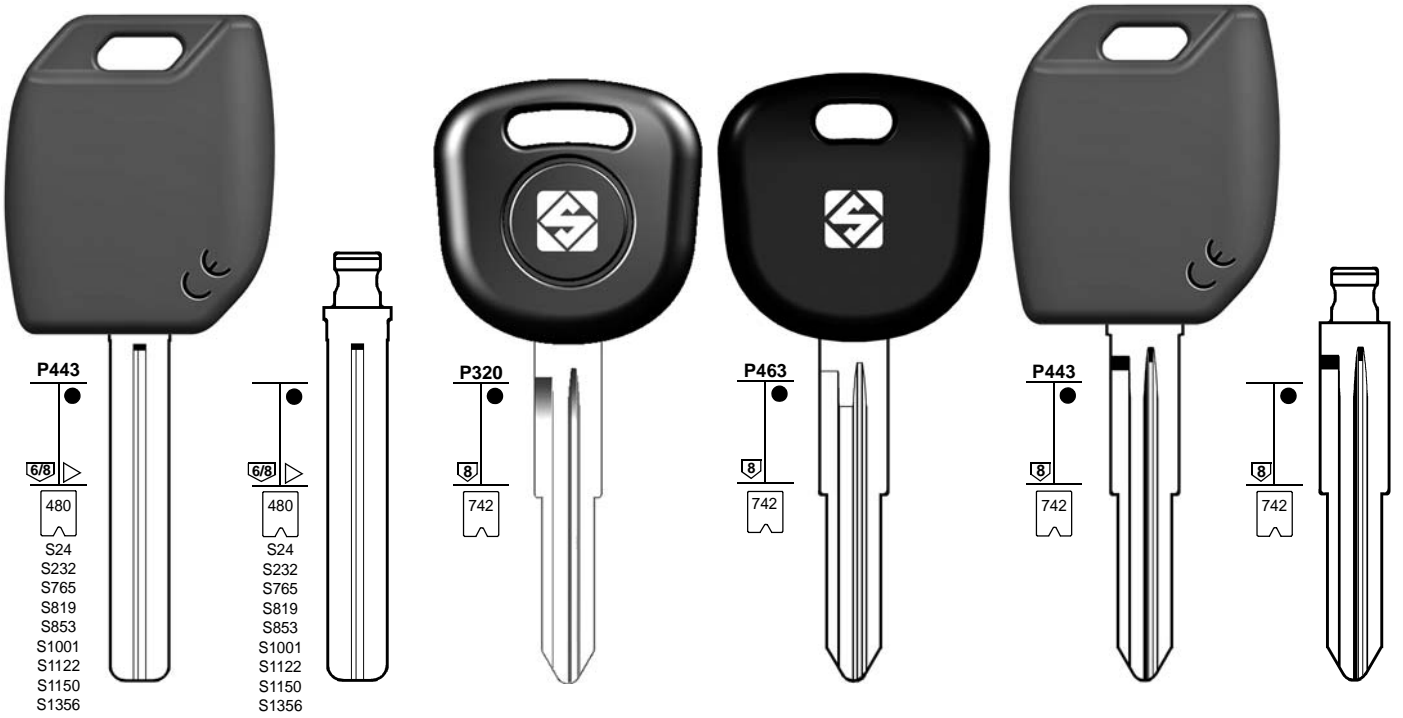

**TOY40MH**  
 MH KEY  
 ..... 1-5000  
 L ..... 0001-1000  
 G ..... 0001-2500  
 J ..... 0001-2500  
 K ..... 0001-2500  
 P ..... 0001-2500  
 ..... 30001-31200

**TOY40FH**  
 FH FLIP  
 ..... 1-5000  
 L ..... 0001-1000  
 J ..... 0001-2500

**KIA3RT14**  
 Y ..... 2001-3000

**KIA3RTE**  
 TE KEY  
 Y ..... 2001-3000

**KIA3RMH**  
 MH KEY  
 Y ..... 2001-3000

**KIA3RFH**  
 FH FLIP  
 Y ..... 2001-3000

FOR:  
PER:

# KIA

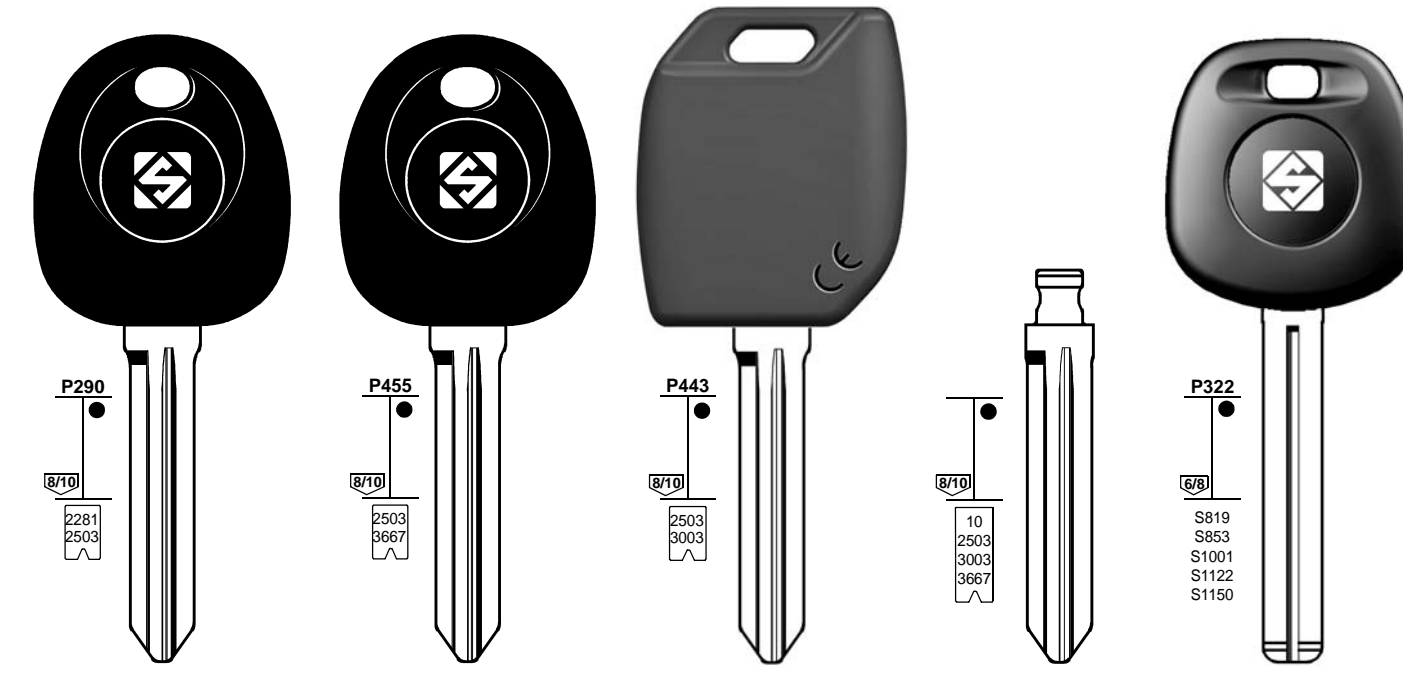

**HYN14RT14**  
 M ..... 1-2500  
 T ..... 1-2500  
 WC ..... 1001-3500

**HYN14RTE**  
 TE KEY  
 M ..... 1-2500  
 T ..... 1-2500  
 WC ..... 1001-3500

**HYN14RMH**  
 MH KEY  
 M ..... 1-2500  
 T ..... 1-2500  
 WC ..... 1001-3500

**HYN14RFH**  
 FH FLIP  
 M ..... 1-2500  
 T ..... 1-2500  
 WC ..... 1001-3500

**KIA7T14**  
 G ..... 0001-2500  
 J ..... 0001-2500  
 K ..... 0001-2500  
 L ..... 0001-1000  
 P ..... 0001-2500



FOR:  
PER:

# KIA

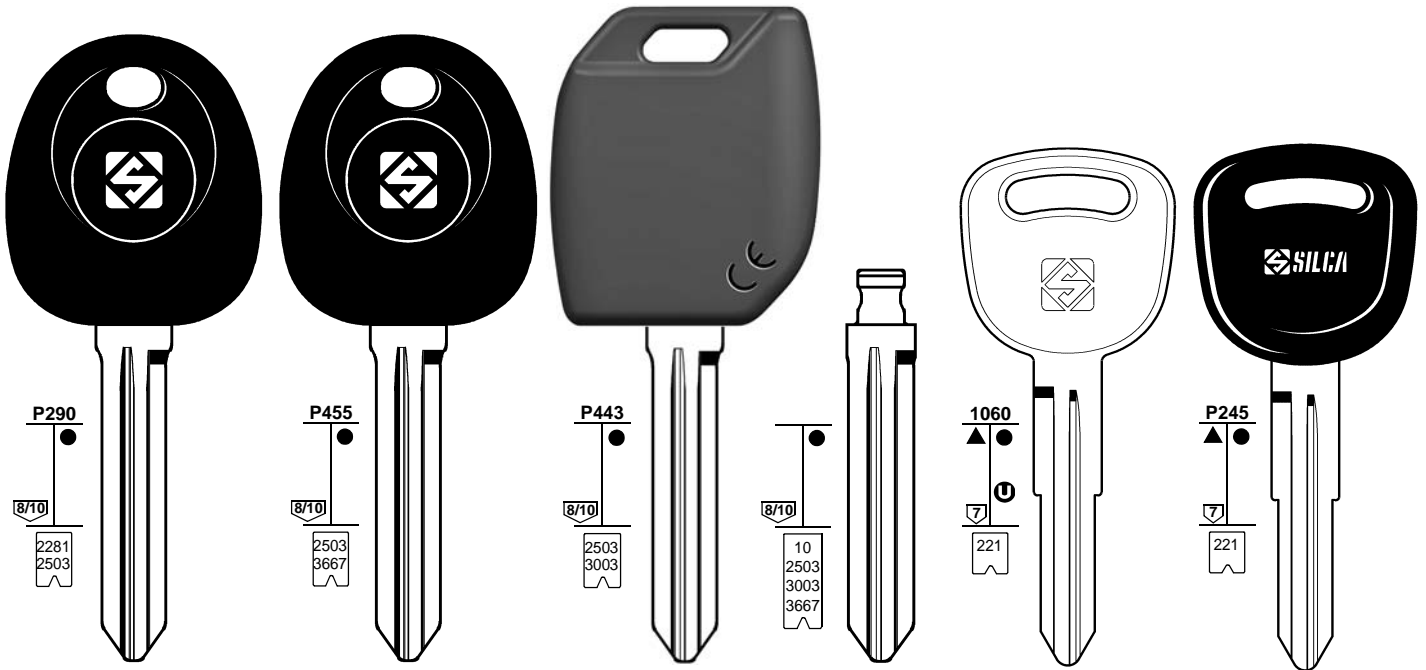

**HYN14T14**

H..... 0001-2500  
 M..... 0001-2500  
 P..... 0001-2500  
 T..... 0001-2500  
 V..... 1-2500



**HYN14TE**

H..... 0001-2500  
 M..... 0001-2500  
 P..... 0001-2500  
 T..... 0001-2500  
 V..... 1-2500



**HYN14MH**

H..... 0001-2500  
 M..... 0001-2500  
 P..... 0001-2500  
 T..... 0001-2500  
 V..... 0001-2500



**HYN14FH**

H..... 0001-2500  
 M..... 0001-2500  
 P..... 0001-2500  
 T..... 0001-2500  
 V..... 0001-2500



**KIA1R**

Y.....  
 7001-8200



**KIA1RAP**

Y.....  
 7001-8200

FOR:  
PER:

# KIA



**KIA3R**

Y..... 2001-3000



**KIA3RAP**

Y..... 2001-3000



**KIA3RT5**

Y..... 2001-3000



**KIA3RT16**

Y..... 2001-3000



**KIA3RTE**

Y..... 2001-3000



**KIA3RMH**

Y..... 2001-3000



**KIA3RFH**

Y..... 2001-3000



**KIA3RT14**

Y..... 2001-3000



FOR:  
PER:

# KIA

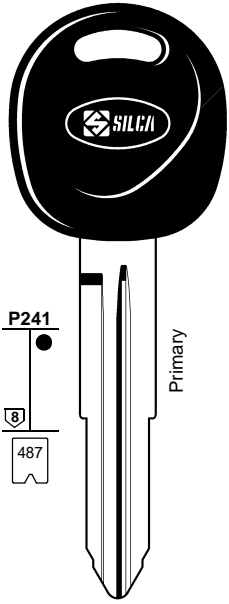

8  
487

**HYN7RAP**  
S . . . . 1-1000

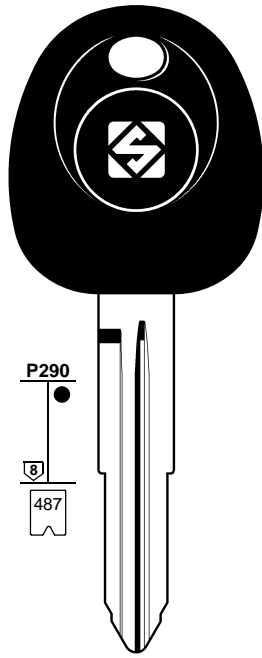

8  
487

**HYN7RT14**  
S . . . . 1-1000

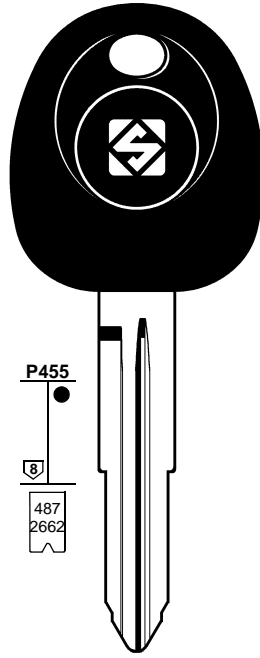

8  
487  
2662

**HYN7RTE**  
S . . . . 1-1000

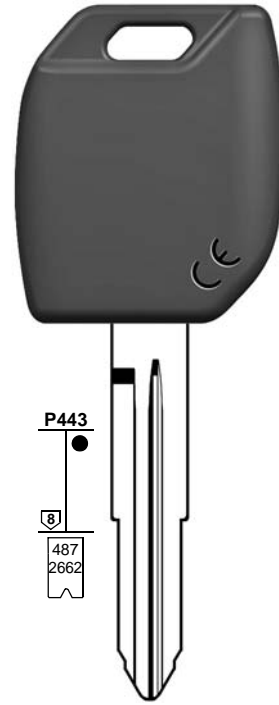

8  
487  
2662

**HYN7RMH**  
S . . . . 1-1000

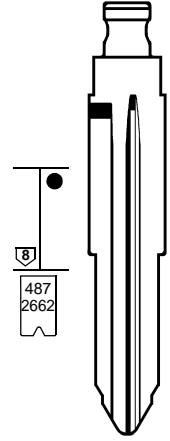

8  
487  
2662

**HYN7RFH**  
S . . . . 1-1000

FOR:  
PER:

# KIA

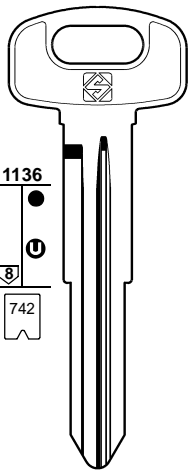

8  
742

**KIA3R**  
Y . . . . 2001-3000

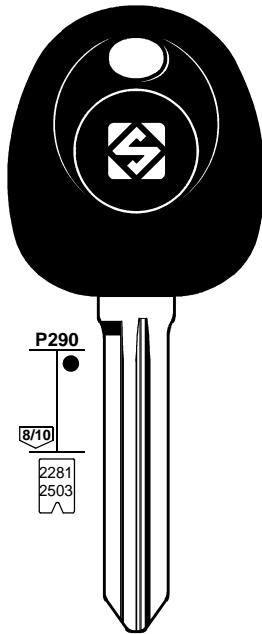

8/10  
2281  
2503

**HYN14RT14**  
M . . . . 1-2500  
T . . . . 1-2500  
WC . . . . 1001-3500



6/8  
S819  
S853  
S1001  
S1122  
S1150

**KIA7T14**  
G . . . . 0001-2500  
J . . . . 0001-2500  
K . . . . 0001-2500  
L . . . . 0001-1000  
P . . . . 0001-2500



6/8  
480  
S24  
S232  
S765  
S819  
S853  
S1001  
S1122  
S1150  
S1356

**TOY40MH**  
. . . . 1-5000  
L . . . . 0001-1000  
G . . . . 0001-2500  
J . . . . 0001-2500  
K . . . . 0001-2500  
P . . . . 0001-2500  
. . . . 30001-31200

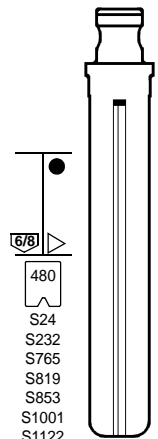

6/8  
480  
S24  
S232  
S765  
S819  
S853  
S1001  
S1122  
S1150  
S1356

**TOY40FH**  
. . . . 1-5000  
L . . . . 0001-1000  
J . . . . 0001-2500



FOR:  
PER:

# KIA



FOR:  
PER:

# KIA

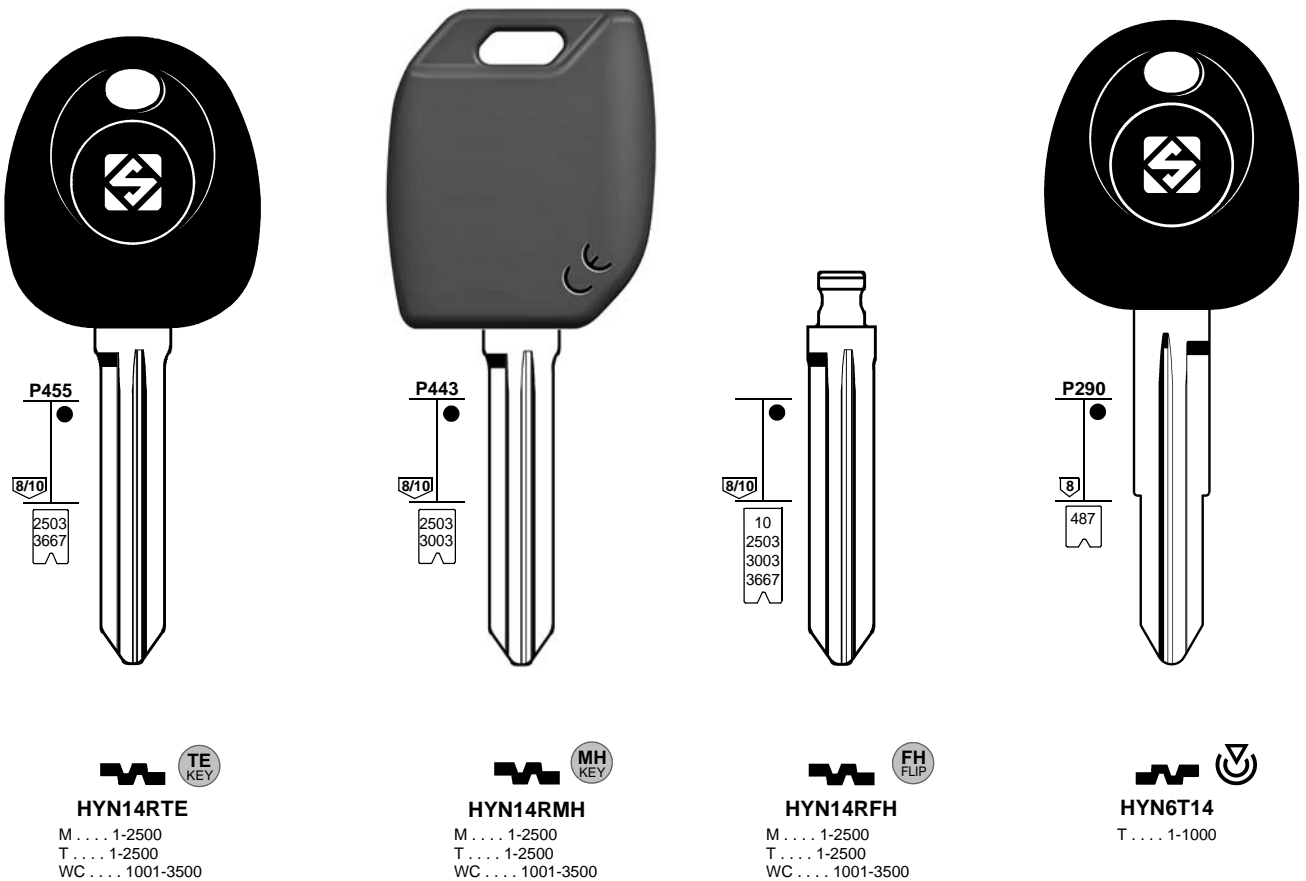





FOR:  
PER:

# KIA

<p><b>P455</b></p> <p>8</p> <p>487 2281 2454</p> <p><b>TE KEY</b></p> <p><b>HYN6TE</b> A ..... 1-1000 R ..... 1-1000 T ..... 1-1000 V ..... 1-1200</p>	<p><b>P443</b></p> <p>8</p> <p>487 2281 2454</p> <p><b>MH KEY</b></p> <p><b>HYN6MH</b> A ..... 1-1000 R ..... 1-1000 T ..... 1-1000 V ..... 1-1200</p>	<p><b>1136</b></p> <p>7</p> <p>221</p> <p><b>FH FLIP</b></p> <p><b>HYN6FH</b> A ..... 1-1000 R ..... 1-1000 T ..... 1-1000 V ..... 1-1200</p>	<p><b>1060</b></p> <p>8</p> <p>1860</p> <p><b>KIA2R</b> Y ..... 7001-8200</p>	<p><b>P443</b></p> <p>7</p> <p>S1214</p> <p><b>MH KEY</b></p> <p><b>KIA5</b> WA ..... 1001-3040</p>	<p><b>P443</b></p> <p>7</p> <p>S1214</p> <p><b>FH FLIP</b></p> <p><b>HUI34MH</b> ..... 00001-02300</p> <p><b>HUI34FH</b> ..... 00001-02300</p>
--	--	---	---	---	--

FOR:  
PER:

## KIA

## KUBOTA

## LADA

## LANCIA

<p><b>P472</b></p> <p>7</p> <p>S1214</p> <p><b>TE KEY</b></p> <p><b>HUI34TE</b> ..... 00001-02300</p>	<p><b>1623</b></p> <p>5</p> <p>3271</p> <p><b>KUB1R</b> ..... 1234</p> <p></p>	<p><b>1499</b></p> <p>5</p> <p>23 26</p> <p><b>NE20NP</b> ..... A/Z A/Z ..... A/Z ..... A/Z 1-2-3-5-7 ..... A/Z 0-4-6-8-9</p>	<p><b>P112</b></p> <p>8</p> <p>203</p> <p><b>LD6RP</b> LU ..... 1-1280</p>	<p><b>P259</b></p> <p>9</p> <p>258</p> <p><b>GT18RT5</b> W ..... 0001-9640</p> <p><b>GIOBERT - TRW SIPEA</b></p>
---	--	---	--	--



FOR:  
PER:

# LANCIA



**SIP16T2**  
.....  
(LA.....)  
1-17735

**SIP16FH**  
..... 1-17735  
LA..... 1-17735

**GT18RT5**  
W.....  
0001-9640

**HU83TE**  
..... 1-2000

**HU83T14**  
..... 1-2000

**HU83MH**  
..... 1-2000

GIOBERT - TRW SIPEA

VALEO

VALEO

FOR:  
PER:

# LANCIA

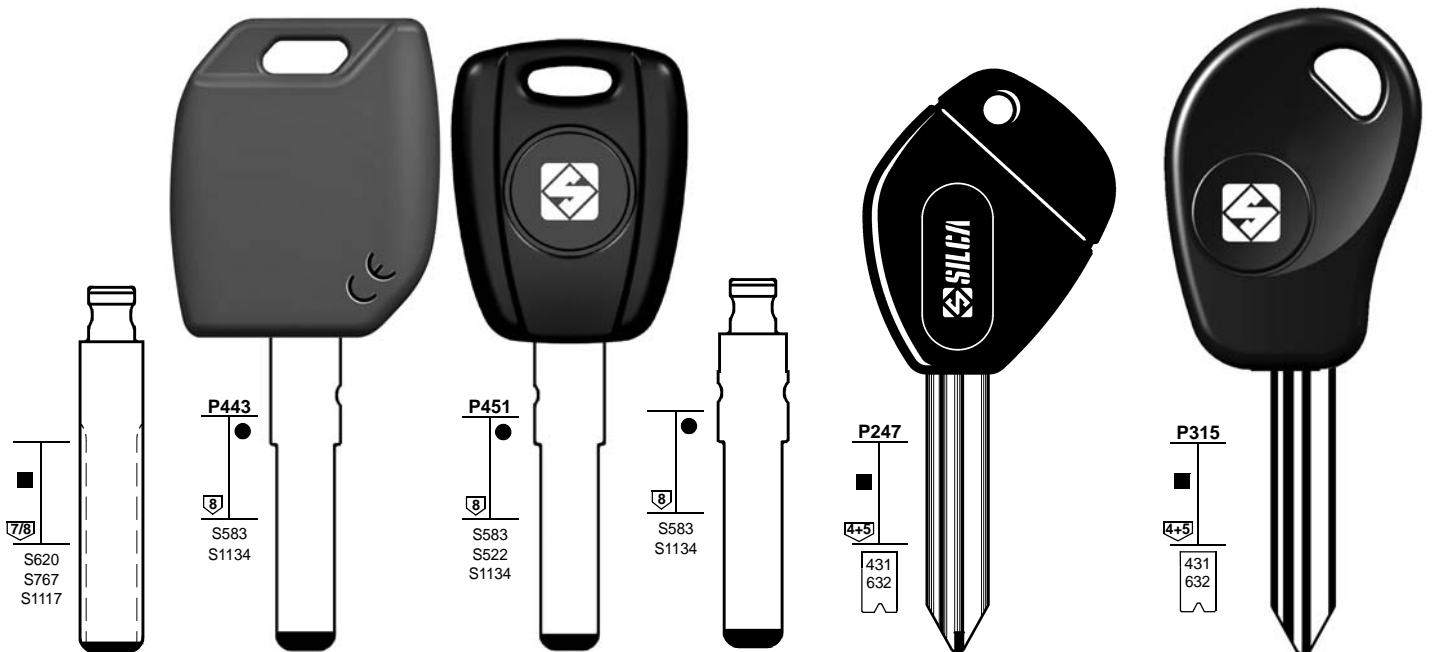

S620  
S767  
S1117

**P443**  
S583  
S1134

**P451**  
S583  
S522  
S1134

S583  
S1134

**P247**  
431  
632

**P315**  
431  
632

**HU83FH**  
..... 1-2000

**SIP22MH**  
DE..... 1-11210

**SIP22TE**  
DE..... 1-11210

**SIP22FH**  
DE..... 1-11210

**SX9CP**  
.....  
0111111-628888  
..... H  
0111111-628888  
63/99..... 1-2-4-6-8  
63/99..... H 1-2-4-6-8

**SX9T5**  
.....  
0111111-628888  
..... H  
0111111-628888  
63/99..... 1-2-4-6-8  
63/99..... H 1-2-4-6-8

VALEO

GIOBERT - TRW SIPEA

GIOBERT - TRW SIPEA



FOR:  
PER:

# LANCIA

Blue head  
Testa blu

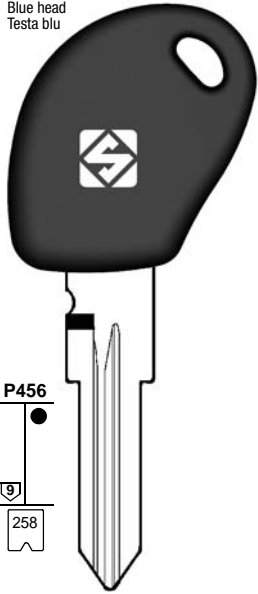

P456  
258

**GT15RBTE**  
W . . . .  
0001-9640

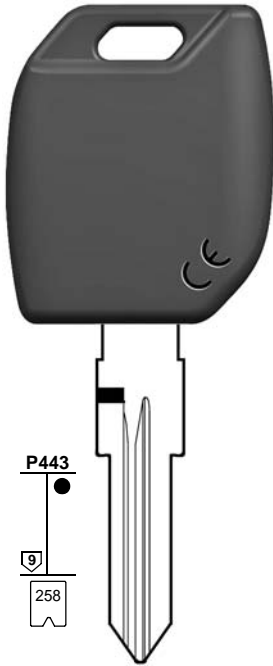

P443  
258

**GT15RMH**  
W . . . .  
0001-9640

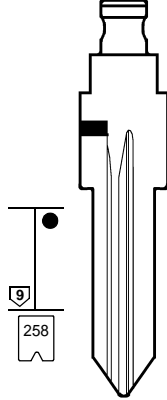

258

**GT15RFH**  
W . . . .  
0001-9640

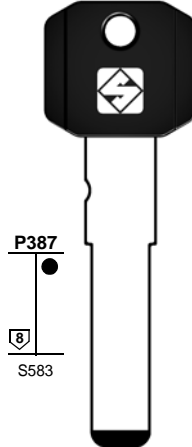

P387  
S583

**SIP22KP**  
DE . . . .  
1-11210

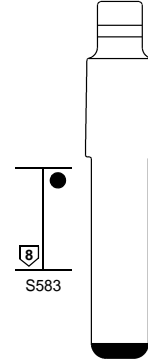

S583

**SIP18T**  
DE . . . .  
1-11210

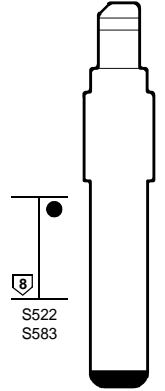

S522  
S583

**SIP29T**  
DE . . . .  
1-11210

GIOBERT - TRW SIPEA

GIOBERT - TRW SIPEA

GIOBERT - TRW SIPEA

GIOBERT - TRW SIPEA

FOR:  
PER:

# LAND ROVER

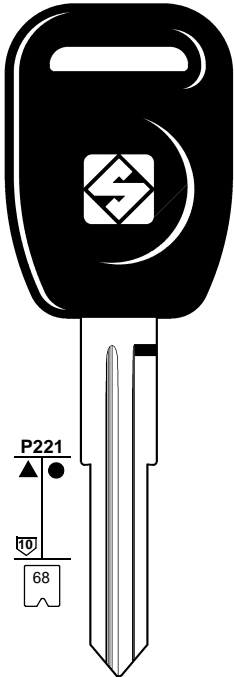

P221  
68

**NE75EP**  
L . . . . 8001-10000

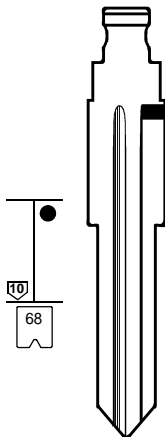

68

**NE75FH**  
L . . . . 8001-10000

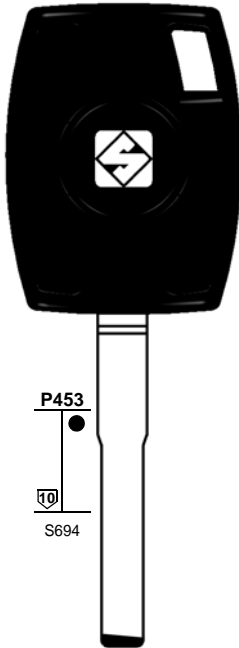

P453  
S694

**HU101TE**  
. . . . 1-4000



P443  
S694

**HU101MH**  
. . . . 1-4000

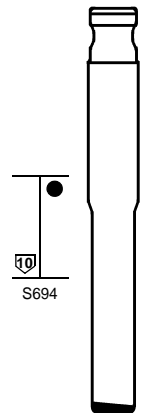

S694

**HU101FH**  
. . . . 1-4000

NEIMAN



FOR:  
PER:

# LAND ROVER

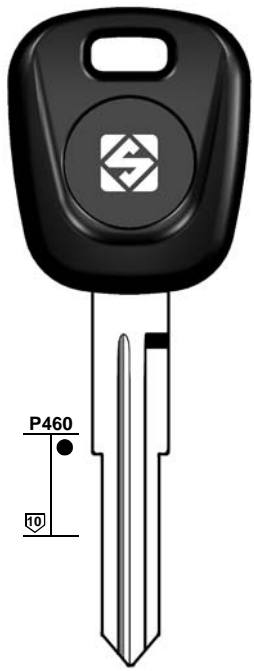

P460  
10

 **TE KEY**  
**NE75TE**

NEIMAN

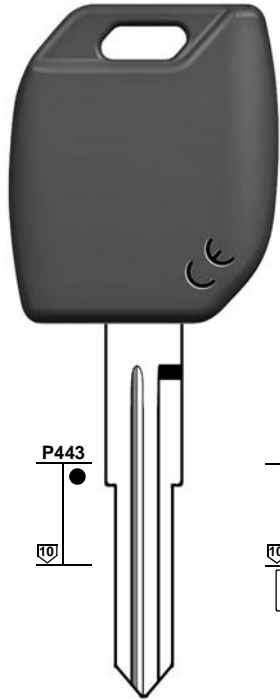

P443  
10

 **MH KEY**  
**NE75MH**

NEIMAN

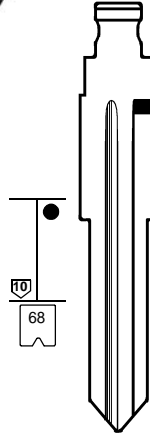

68  
10

 **FH FLIP**  
**NE75FH**  
L . . . . . 8001-10000

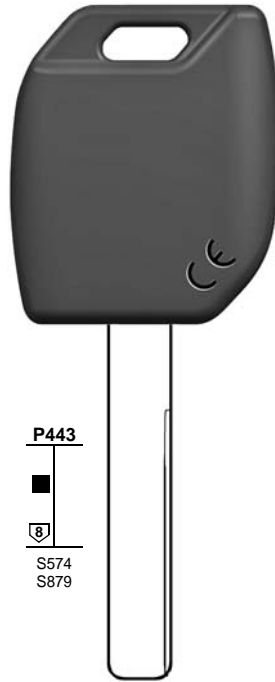

P443  
8  
S574  
S879

 **MH KEY**  
**HU92RMH**  
. . . . . 1-8100

HUF - WITTE

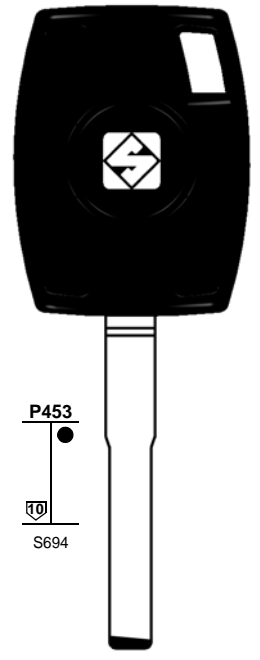

P453  
10  
S694

 **TE KEY**  
**HU101TE**  
. . . . . 1-4000

HUF

FOR:  
PER:

# LAND ROVER

# LDV

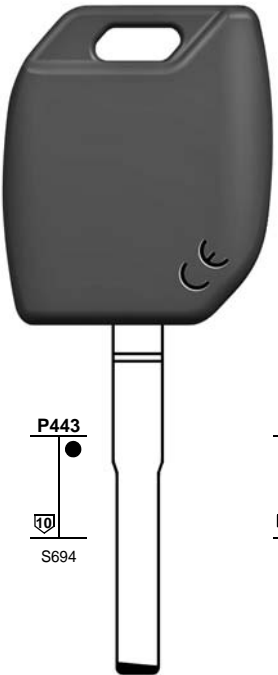

P443  
10  
S694

 **MH KEY**  
**HU101MH**  
. . . . . 1-4000

HUF

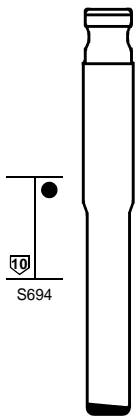

P443  
10  
S694

 **FH FLIP**  
**HU101FH**  
. . . . . 1-4000

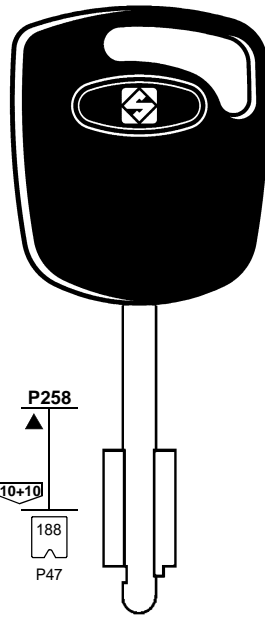

P258  
10+10  
188  
P47

 **TE KEY**  
**FO19TE**  
C . . . . . 1-2-3-4-5

CHUBB

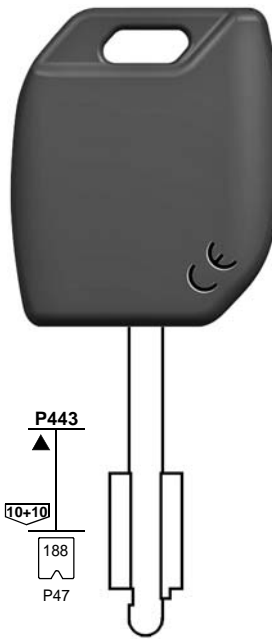

P443  
10+10  
188  
P47

 **MH KEY**  
**FO19MH**  
C . . . . . 1-2-3-4-5

CHUBB

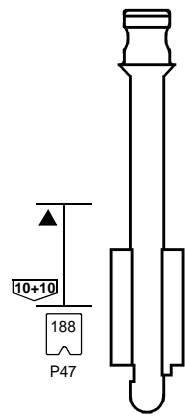

P443  
10+10  
188  
P47

 **FH FLIP**  
**FO19FH**  
C . . . . . 12345





FOR:  
PER:

# LEXUS

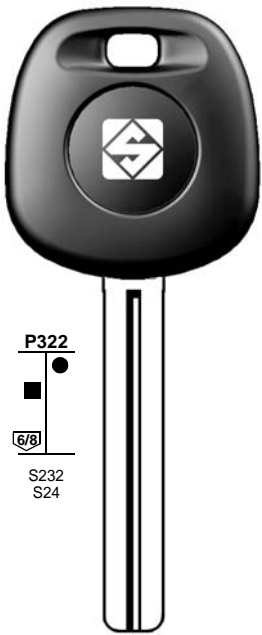

P322  
S232  
S24

  
**TOY40BT4**  
..... 1-5000

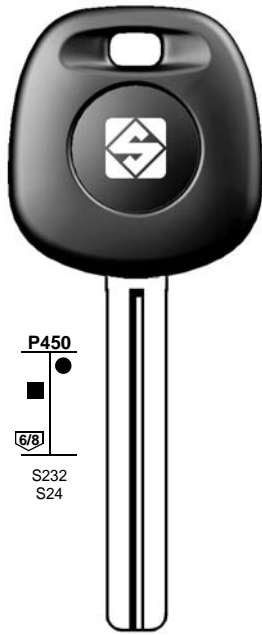

P450  
S232  
S24

  
**TOY40BTE**  
..... 1-5000

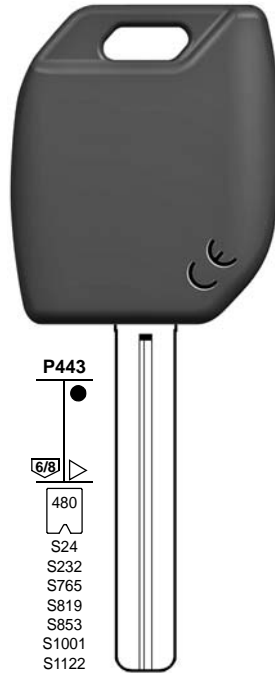

P443  
480  
S24  
S232  
S765  
S819  
S853  
S1001  
S1122  
S1150  
S1356

  
**TOY40MH**  
..... 1-5000  
L ..... 0001-1000  
G ..... 0001-2500  
J ..... 0001-2500  
K ..... 0001-2500  
P ..... 0001-2500  
..... 30001-31200

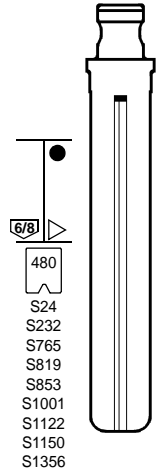

480  
S24  
S232  
S765  
S819  
S853  
S1001  
S1122  
S1150  
S1356

  
**TOY40FH**  
..... 1-5000  
L ..... 0001-1000  
J ..... 0001-2500

FOR:  
PER:

# LEXUS



P322  
S397  
S855

  
**TOY48BT4**  
..... 40000-49999



P322  
S397  
S855

  
**TOY48BTE**  
..... 40000-49999







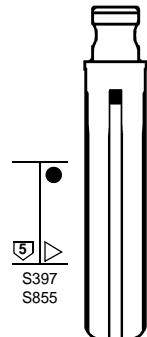











P443  
S397  
S855

  
**TOY48MH**  
..... 40000-49999



S397  
S855

  
**TOY48FH**  
..... 40000-49999

1	2	2a	3	3a	3b	e1+e2		6	42+71	72	43+44a	12	15
						GTI COMPATIBLE		IGNITION 					
CAR MAKE MODEL	FROM	TO	SILCA REF.	SILCA REF.	SILCA REF.	COPY	GEN.	TRANSP. TYPE	FAST COPY PLUS RW4 PLUS FAST COPY/RW4	FAST COPY PLUS RW4 PLUS	FAST COPY RW4	STP	
													
For more info on the uses of car keys, refer to the Silca Electronic Keys Catalogue: 													
<b>LEXUS</b>													
ALTEZZA [J]	1999		TOY48BT4					TEXAS	4C				E
ALTEZZA [J]	1999		TOY48MH	TOY48BTE	TOY48FH	Y	Y	TEXAS	4C	Y	P-BOX		
CELSIOR [J]	1997		TOY40BT4					TEXAS	4C				E
CELSIOR [J]	1997		TOY40MH	TOY40BTE	TOY40FH	Y	Y	TEXAS	4C	Y	P-BOX		
CT200H	2011		SMARTKEY					TEX / CR	XX				
ES300	1998	2001	TOY40BT4					TEXAS	4C				E
ES300	1998	2001	TOY40MH	TOY40BTE	TOY40FH	Y	Y	TEXAS	4C	Y	P-BOX		
ES300	2002	2003	TOY48BT4					TEXAS	4C				I
ES300	2002	2003	TOY48MH	TOY48BTE	TOY48FH	Y	Y	TEXAS	4C	Y	P-BOX		
ES330	2004	2007						TEX / CR	68				
ES330	2004	2007	TOY48MH	TOY48BTE	TOY48FH	Y		TEX / CR	68	Y	P-BOX		
ES350	2007							TEX / CR	68				
GS/LS/LX	1998		TOY48BT4					TEXAS	4C				E
GS/LS/LX	1998		TOY48MH	TOY48BTE	TOY48FH	Y	Y	TEXAS	4C	Y	P-BOX		
GS300	1998	2001	TOY48BT4					TEXAS	4C				E
GS300	1998	2005	TOY48MH	TOY48BTE	TOY48FH	Y	Y	TEXAS	4C	Y	P-BOX		
GS300	2002	2005	TOY48BT4					TEXAS	4C				I
GS300	2005	2007						TEX / CR	68				I
GS300	2005	2007	TOY48MH	TOY48BTE	TOY48FH	Y		TEX / CR	68	Y	P-BOX		
GS300/400 [J]	1998		TOY48BT4					TEXAS	4C				E
GS300/400 [J]	1998		TOY48MH	TOY48BTE	TOY48FH	Y	Y	TEXAS	4C	Y	P-BOX		
GS350	2007							TEX / CR	68				
GS400	1998	2001	TOY48BT4					TEXAS	4C				E
GS400	1998	2001	TOY48MH	TOY48BTE	TOY48FH	Y	Y	TEXAS	4C	Y	P-BOX		
GS430	2001	2005	TOY48BT4					TEXAS	4C				I
GS430	2001	2005	TOY48MH	TOY48BTE	TOY48FH	Y	Y	TEXAS	4C	Y	P-BOX		
GS430	2005	2007						TEX / CR	68				
GS430	2005	2007	TOY48MH	TOY48BTE	TOY48FH	Y		TEX / CR	68	Y	P-BOX		
GS450h	2007							TEX / CR	68				
GS460	2007							TEX / CR	68				
GX470	2003	2007						TEX / CR	68				
GX470	2003	2007	TOY48MH	TOY48BTE	TOY48FH	Y		TEX / CR	68	Y	P-BOX		
HS250H	2010		SMARTKEY					TEX / CR	XX				
IS200	1999	2005	TOY48BT4					TEXAS	4C				E
IS200	1999	2005	TOY48MH	TOY48BTE	TOY48FH	Y	Y	TEXAS	4C	Y	P-BOX		
IS220d	2005		SMARTKEY					TEX / CR	68				
IS250	2005		SMARTKEY					TEX / CR	68				
IS300	2001	2005	TOY48BT4					TEXAS	4C				E
IS300	2001	2005	TOY48MH	TOY48BTE	TOY48FH	Y	Y	TEXAS	4C	Y	P-BOX		
IS300	2002	2003	TOY48BT4					TEXAS	4C				I
IS300	2005		SMARTKEY					TEX / CR	68				
IS350	2005		SMARTKEY					TEX / CR	68				
LAND CRUISER [J]	1999		TOY40BT4					TEXAS	4C				E
LAND CRUISER [J]	1999		TOY40MH	TOY40BTE	TOY40FH	Y	Y	TEXAS	4C	Y	P-BOX		
LS200	1999		TOY48BT4					TEXAS	4C				E
LS200	1999		TOY48MH	TOY48BTE	TOY48FH	Y	Y	TEXAS	4C	Y	P-BOX		

FOR:  
PER:

# LEXUS

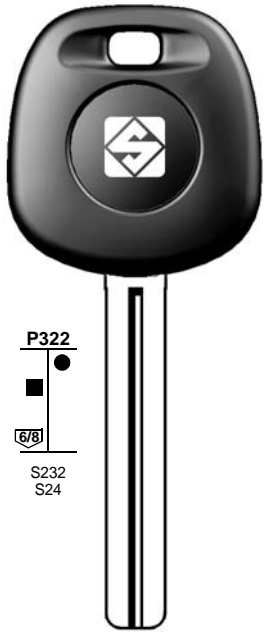

**P322**  
■ ●  
6/8  
S232  
S24

   
**TOY40BT4**  
..... 1-5000

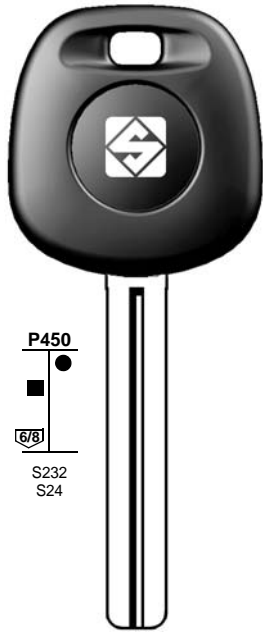

**P450**  
■ ●  
6/8  
S232  
S24

   
**TOY40BTE**  
..... 1-5000



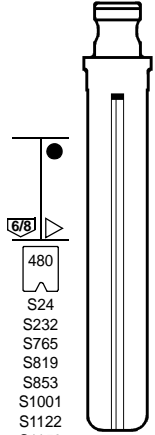

**P443**  
●  
6/8  
480  
S24  
S232  
S765  
S819  
S853  
S1001  
S1122  
S1150  
S1356

   
**TOY40MH**  
..... 1-5000  
L ..... 0001-1000  
G ..... 0001-2500  
J ..... 0001-2500  
K ..... 0001-2500  
P ..... 0001-2500  
..... 30001-31200



●  
6/8  
480  
S24  
S232  
S765  
S819  
S853  
S1001  
S1122  
S1150  
S1356

   
**TOY40FH**  
..... 1-5000  
L ..... 0001-1000  
J ..... 0001-2500

FOR:  
PER:

# LEXUS

# LIGIER (MICROCARS)



**P322**  
■  
5  
S397  
S855

   
**TOY48BT4**  
..... 40000-49999



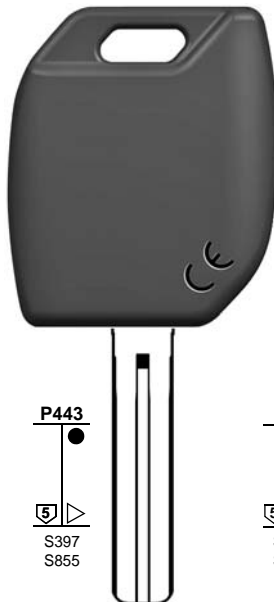

**P450**  
■  
5  
S397  
S855

   
**TOY48BTE**  
..... 40000-49999



**P443**  
●  
5  
S397  
S855

   
**TOY48MH**  
..... 40000-49999

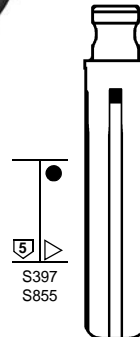





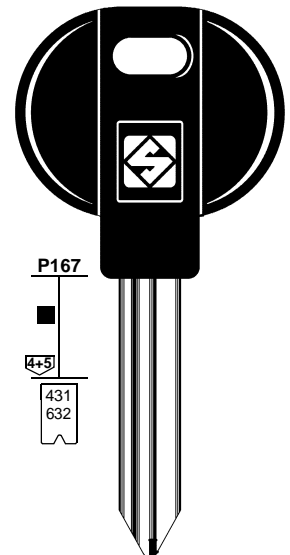











●  
5  
S397  
S855

   
**TOY48FH**  
..... 40000-49999



**P167**  
■  
4+5  
431  
632

  
**SX9AP**  
63/99 ..... H 12468  
63/99 ..... 12468  
..... H 0111111-6288888  
..... 0111111-6288888

1	2	2a	3	3a	3b	e1+e2		6	42+71	72	43+44a	12	15
						<b>GTI COMPATIBLE</b>		<b>IGNITION</b> 					
<b>CAR MAKE MODEL</b>	<b>FROM</b>	<b>TO</b>	<b>SILCA REF.</b>	<b>SILCA REF.</b>	<b>SILCA REF.</b>	<b>COPY</b>	<b>GEN.</b>	<b>TRANSP. TYPE</b>	<b>FAST COPY PLUS RW4 PLUS FAST COPY/RW4</b>	<b>FAST COPY PLUS RW4 PLUS</b>	<b>FAST COPY RW4</b>	<b>STP</b>	
													
For more info on the uses of car keys, refer to the Silca Electronic Keys Catalogue: 													
<b>LEXUS</b>													
LS400	1997	2000	TOY40BT4					TEXAS	4C				E
LS400	1997	2000	TOY40MH	TOY40BTE	TOY40FH	Y	Y	TEXAS	4C	Y	P-BOX		
LS400	1999	2001	TOY48BT4					TEXAS	4C				E
LS400	1999	2003	TOY48MH	TOY48BTE	TOY48FH	Y	Y	TEXAS	4C	Y	P-BOX		
LS400	2002	2003	TOY48BT4					TEXAS	4C				I
LS430	2001	2006						TEX / CR	68				
LS430	2001	2006	TOY48MH	TOY48BTE	TOY48FH	Y		TEX / CR	68	Y	P-BOX		
LS430	2004	2006	SMARTKEY					TEX / CR	68				
LS460	2007		SMARTKEY					TEX / CR	68				
LS600	2010		SMARTKEY					TEX / CR	XX				
LX450	1998		TOY40BT4					TEXAS	4C				E
LX450	1998		TOY40MH	TOY40BTE	TOY40FH	Y	Y	TEXAS	4C	Y	P-BOX		
LX470	1999	2000	TOY40BT4					TEXAS	4C				E
LX470	1999	2000	TOY40MH	TOY40BTE	TOY40FH	Y	Y	TEXAS	4C	Y	P-BOX		
LX470	2001	2002	TOY48BT4					TEXAS	4C				
LX470	2001	2002	TOY48MH	TOY48BTE	TOY48FH	Y	Y	TEXAS	4C	Y	P-BOX		
LX470	2003	2008						TEX / CR	68				
LX470	2003	2008	TOY48MH	TOY48BTE	TOY48FH	Y		TEX / CR	68	Y	P-BOX		
LX570	2008		SMARTKEY					TEX / CR	68				
RX300	1999	2001	TOY48BT4					TEXAS	4C				E
RX300	1999	2003	TOY48MH	TOY48BTE	TOY48FH	Y	Y	TEXAS	4C	Y	P-BOX		
RX300	2002	2003	TOY48BT4					TEXAS	4C				I
RX330	2004	2009						TEX / CR	68				E
RX330	2004	2009	TOY48MH	TOY48BTE	TOY48FH	Y		TEX / CR	68	Y	P-BOX		
RX350	2004	2011						TEX / CR	68				
RX350	2004	2011	TOY48MH	TOY48BTE	TOY48FH	Y		TEX / CR	68	Y	P-BOX		
RX350	2010		SMARTKEY					TEX / CR	XX				
RX400h	2005	2009						TEX / CR	68				
RX400h	2005	2009	TOY48MH	TOY48BTE	TOY48FH	Y		TEX / CR	68	Y	P-BOX		
RX400h	2010		SMARTKEY					TEX / CR	XX				
RX450h	2010							TEX / CR	68				
RX450h	2010		TOY48MH	TOY48BTE	TOY48FH	Y		TEX / CR	68	Y	P-BOX		
RX450h	2011		SMARTKEY					TEX / CR	XX				
SC300/400	1998	2001	TOY40BT4					TEXAS	4C				E
SC300/400	1998	2003	TOY40MH	TOY40BTE	TOY40FH	Y	Y	TEXAS	4C	Y	P-BOX		
SC300/400	2002	2003	TOY40BT4					TEXAS	4C				I
SC430	2002	2010						TEX / CR	68				
SC430	2002	2010	TOY48MH	TOY48BTE	TOY48FH	Y		TEX / CR	68	Y	P-BOX		
<b>LIGIER (MICROCARS)</b>													
IXO	2010		SX9AP										
JS			SX9AP										
NOVA	1999	2004	SX9AP										
OPTIMAX	2010		SX9AP										
X-T00	2006	2012	SX9AP										

FOR:  
PER:

# LINCOLN



P273



.... X  
0001-1706



**FO38RTE**



**FO38RT3**



**FO38RT17**

STRATTEC



P443



**FO38RMH**

.... X  
0001-1706

STRATTEC

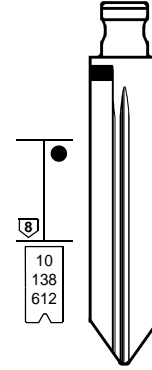

**FO38RFH**

... A ... 101-381.501-579  
... B ... 101-410.501-602  
... C ... 101-404.501-624  
... D ... 101-340.501-602  
... E ... 101-304.501-579  
... X 1-1706

FOR:  
PER:

# LINCOLN



P442



**H72-EK3**  
.... X  
1-1706

STRATTEC



P336



Vallet  
for FO38RT3



**H82-PT**  
.... X  
0001-1706

STRATTEC

















P336



Master



**H74-PT**  
.... X  
0001-1706

1	2	2a	3	3a	3b	e1+e2		6	42+71	72	43+44a	12	15
						GTI COMPATIBLE		IGNITION 					
CAR MAKE MODEL	FROM	TO	SILCA REF.	SILCA REF.	SILCA REF.	COPY	GEN.	TRANSP. TYPE	FAST COPY PLUS RW4 PLUS FAST COPY/RW4	FAST COPY PLUS RW4 PLUS	FAST COPY RW4	STP	
													
For more info on the uses of car keys, refer to the Silca Electronic Keys Catalogue: 													
<b>LINCOLN</b>													
AVIATOR	2003	2007	FO38RT17					TEX / CR	63				C
AVIATOR	2003	2007	FO38RMH	FO38RTE	FO38RFH	Y	Y	TEX / CR	63	Y	P-BOX		
BLACKWOOD	2002	2003	FO38RT3					TEXAS	4C				C
BLACKWOOD	2002	2003	H82-PT					TEXAS	4C				C
BLACKWOOD	2002	2003	H72-EK3					TEXAS	4C	Y	Y		
BLACKWOOD	2002	2003	FO38RMH	FO38RTE	FO38RFH	Y	Y	TEXAS	4C	Y	P-BOX		
CLS	2001												
CONTINENTAL	1998	2002	FO38RT3					TEXAS	4C				C
CONTINENTAL	1998	2002	H82-PT					TEXAS	4C				C
CONTINENTAL	1998	2002	FO38RMH	FO38RTE	FO38RFH	Y	Y	TEXAS	4C	Y	P-BOX		
CONTINENTAL	1998	2002	H72-EK3					TEXAS	4C	Y	Y		
CONTINENTAL	2002	2004	FO38RT17					TEX / CR	63				C
CONTINENTAL	2002	2004	FO38RMH	FO38RTE	FO38RFH	Y	Y	TEX / CR	63	Y	P-BOX		
LHS	1998		FO38RT3					TEXAS	4C				C
LHS	1998		FO38RMH	FO38RTE	FO38RFH	Y	Y	TEXAS	4C	Y	P-BOX		
LS	2000	2006	H74-PT					TEX / CR	60				C
LS	2000	2006	FO38RMH	FO38RTE	FO38RFH	Y	Y	TEX / CR	60	Y	P-BOX		
LS	2003	2006	FO38RT17					TEX / CR	63				C
LS	2003	2006	FO38RMH	FO38RTE	FO38RFH	Y	Y	TEX / CR	63	Y	P-BOX		
MARK LT	2005	2009	FO38RT17					TEX / CR	63				C
MARK LT	2005	2009	FO38RMH	FO38RTE	FO38RFH	Y	Y	TEX / CR	63	Y	P-BOX		
MARK LT	2011							TEX / CR	63				
MARK VIII	1997	1998						MOTOROLA					
MKS	2009							TEX / CR	63				
MKT	2010		SMARTKEY					TEX / CR	63				
MKX	2007	2010	FO38RT17					TEX / CR	63				C
MKX	2007	2010	FO38RMH	FO38RTE	FO38RFH	Y	Y	TEX / CR	63	Y	P-BOX		
MKX	2011		SMARTKEY					TEX / CR	63				
MKX	2011							TEX / MA	6E				
MKZ	2006	2011	FO38RT17					TEX / CR	63				C
MKZ	2006	2011	FO38RMH	FO38RTE	FO38RFH	Y	Y	TEX / CR	63	Y	P-BOX		
MKZ	2011							TEX / MA	6E				
NAVIGATOR	1997	1998	FO38RT3					TEXAS	4C				C
NAVIGATOR	1997	2002	FO38RMH	FO38RTE	FO38RFH	Y	Y	TEXAS	4C	Y	P-BOX		
NAVIGATOR	1997	2002	H72-EK3					TEXAS	4C	Y	Y		
NAVIGATOR	1999	2002	FO38RT3					TEXAS	4C				C
NAVIGATOR	2002	2004	FO38RT17					TEX / CR	63				C
NAVIGATOR	2002	2008	FO38RMH	FO38RTE	FO38RFH	Y	Y	TEX / CR	63	Y	P-BOX		
NAVIGATOR	2005	2008	FO38RT17					TEX / CR	63				C
NAVIGATOR	2009							TEX / MA	6E				C
TOWN CAR	1998	2002	FO38RT3					TEXAS	4C				C
TOWN CAR	1998	2002	H82-PT					TEXAS	4C				C
TOWN CAR	1998	2002	H72-EK3					TEXAS	4C	Y	Y		
TOWN CAR	1998	2002	FO38RMH	FO38RTE	FO38RFH	Y	Y	TEXAS	4C	Y	P-BOX		
TOWN CAR	2003		FO38RMH	FO38RTE	FO38RFH	Y	Y	TEX / CR	63	Y	P-BOX		
TOWN CAR	2003	2004	FO38RT17					TEX / CR	63				C
TOWN CAR	2005		FO38RT17					TEX / CR	63				C
ZEPHYR	2006		FO38RT17					TEX / CR	63				C
ZEPHYR	2006		FO38RMH	FO38RTE	FO38RFH	Y	Y	TEX / CR	63	Y	P-BOX		

FOR:  
PER:

# MARUTI SUZUKI

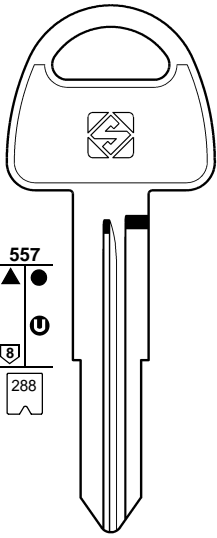

**SZ11**

..... 18100-19299

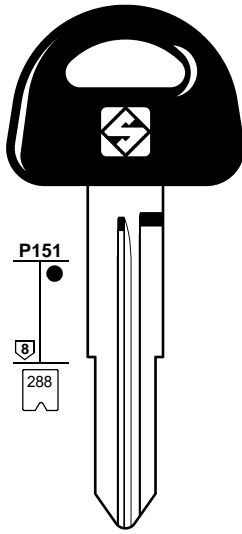

**SZ11P**

..... 18100-19299

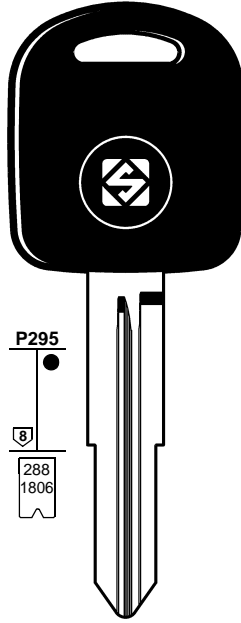

**SZ11TE**

..... 18100-19299  
..... 71001-72500

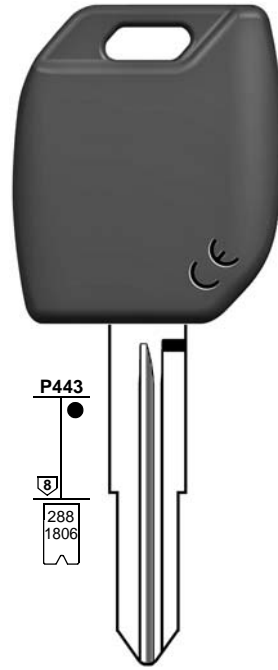

**SZ11MH**

..... 18100-19299  
..... 71001-72500

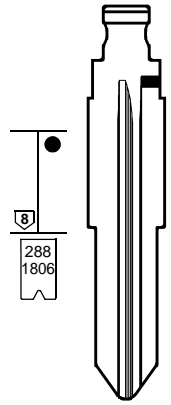

**SZ11FH**

.....  
18100-19299

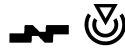

**SZ11T18**

..... 18100-19299

FOR:  
PER:

# MARUTI SUZUKI

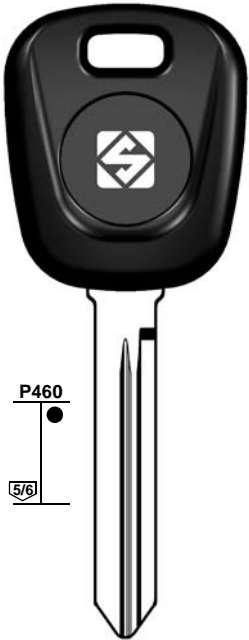

**SZ18TE**

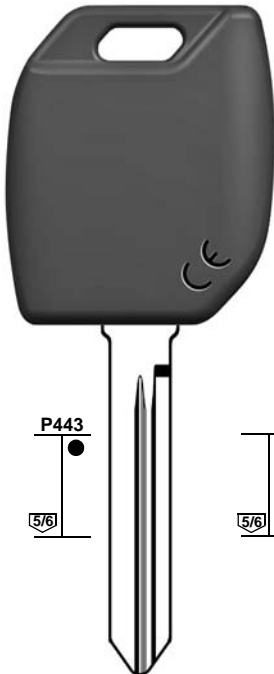

**SZ18MH**

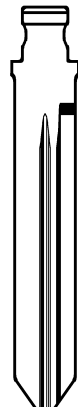

**SZ18FH**

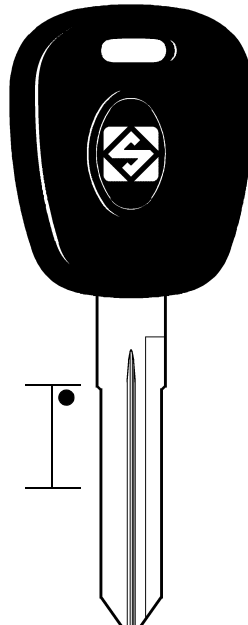

**SZ19RP**

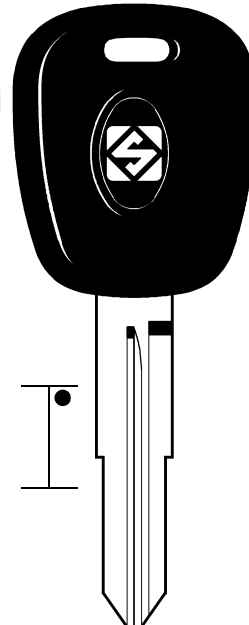

**SZ20P**

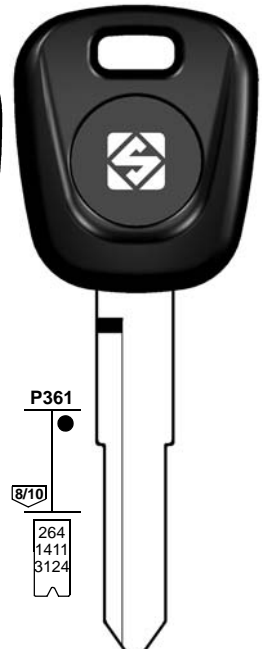

**HU133RT14**

..... 50001-51308  
U ..... 1-2000  
IP ..... 5001-6308





FOR:  
PER:

# MARUTI SUZUKI

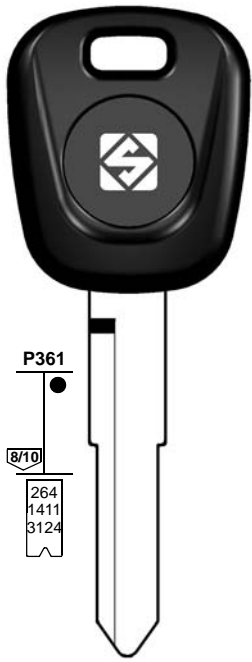

P361  
8/10  
264  
1411  
3124



**HU133RT14**

..... 50001-51308  
U ..... 1-2000  
IP ..... 5001-6308



**HU133RT12**

..... 50001-51308

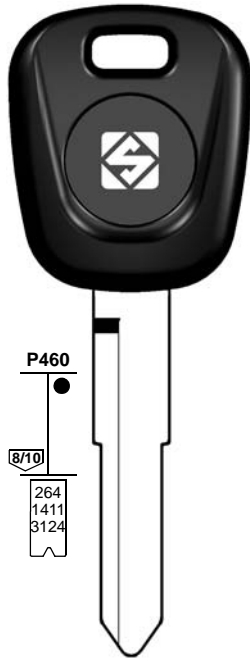

P460  
8/10  
264  
1411  
3124



**HU133RTE**

..... 50001-51308  
U ..... 1-2000  
IP ..... 5001-6308

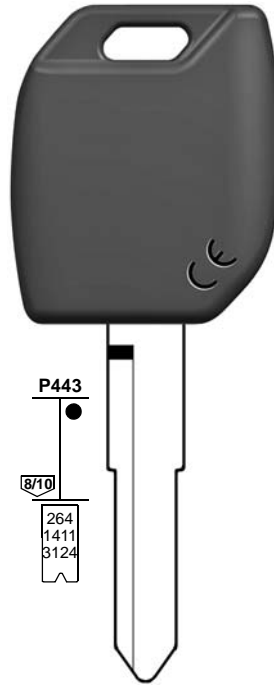

P443  
8/10  
264  
1411  
3124



**HU133RMH**

..... 50001-51308  
U ..... 1-2000  
IP ..... 5001-6308

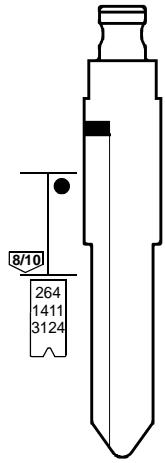

8/10  
264  
1411  
3124



**HU133RFH**

..... 50001-51308  
U ..... 1-2000  
IP ..... 5001-6308

HUF

HUF

FOR:  
PER:

# MARUTI SUZUKI



P460  
7



**SZ18RTE**

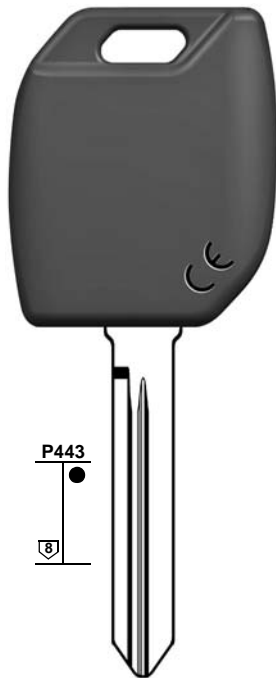

P443  
8



**SZ18RMH**

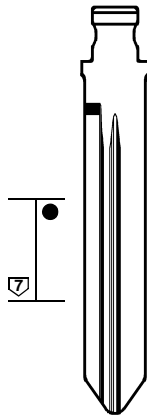

7



**SZ18FH**

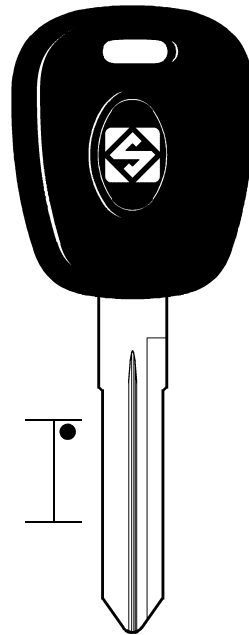

7

**SZ19P**

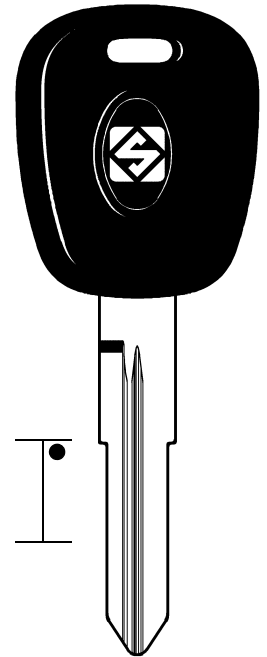

7

**SZ21RP**



FOR:  
PER:

# MARUTI SUZUKI

**P295**  
8  
288

**P295**  
8  
288  
1806

**P443**  
8  
288  
1806

**P443**  
8  
288  
1806

**P361**  
8/10  
264  
1411  
3124

**SZ11RT18**  
..... 18100-19299  
..... 19300-19617

**SZ11RTE**  
..... 18100-19299  
..... 19300-19617

**SZ11RMH**  
..... 18100-19299  
..... 19300-19617

**SZ11RFH**  
..... 18100-19299  
..... 19300-19617

**HU133RT14**  
..... 50001-51308  
U ..... 1-2000  
IP ..... 5001-6308

**SZ21RP**

FOR:  
PER:

# MAZDA

**P460**  
8/10  
264  
1411  
3124

**P443**  
8/10  
264  
1411  
3124

**P443**  
8/10  
264  
1411  
3124

**P115**  
▲  
■  
6  
220  
S755  
P52  
P435

**P258**  
6  
220  
S755  
P52  
P435

**P443**  
▲  
■  
6  
220  
S755  
P52  
P435

**HU133RTE**  
..... 50001-51308  
U ..... 1-2000  
IP ..... 5001-6308

**HU133RMH**  
..... 50001-51308  
U ..... 1-2000  
IP ..... 5001-6308

**HU133RFH**

**FO21P**  
T ..... 1-1050  
T ..... 1-2330  
T ..... 1051-2330  
T ..... 1-2-3-4

**FO21T3**  
T ..... 1-1050  
T ..... 1-2330  
T ..... 1051-2330  
T ..... 1-2-3-4

**FO21TE**  
T ..... 1-1050  
T ..... 1-2330  
T ..... 1051-2330  
T ..... 1-2-3-4

**FO21MH**  
T ..... 1-1050  
T ..... 1-2330  
T ..... 1051-2330  
T ..... 1-2-3-4

**FO21FH**  
T ..... 1-1050  
T ..... 1-2330  
T ..... 1051-2330  
T ..... 1-2-3-4

HUF

TIBBE - VALEO

TIBBE - VALEO



FOR:  
PER:

# MAZDA

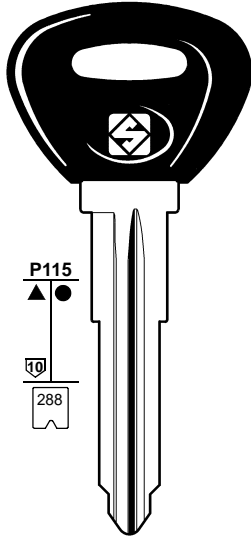

**MAZ20REP**  
..... 10100-12283

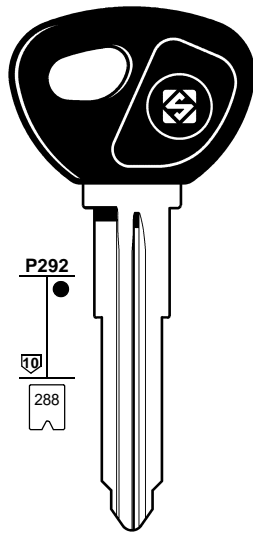

**MAZ13T5**  
..... 10100-12283

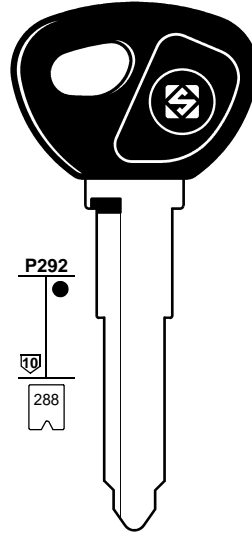

**MAZ24RT5**  
..... 10100-12283

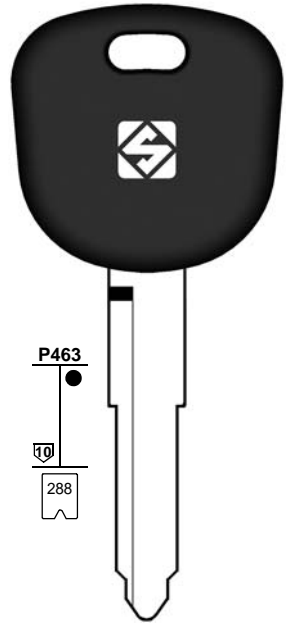

**MAZ24RTE**  
..... 10100-12283

**MAZ20RT5**  
..... 10100-12283

**MAZ24RT17**  
..... 10100-12283

FOR:  
PER:

# MAZDA

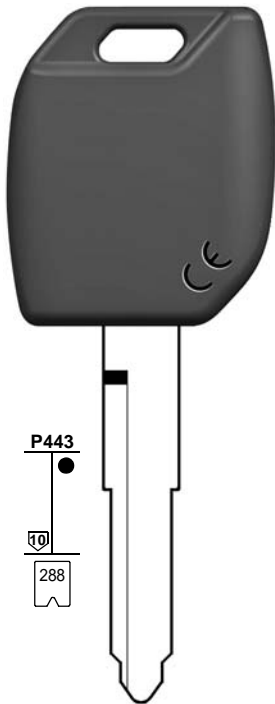

**MAZ24RMH**  
..... 10100-12283

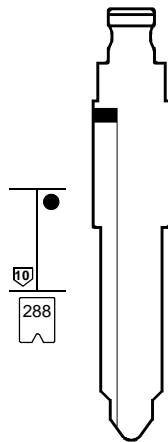

**MAZ24RFH**  
..... 10100-12283

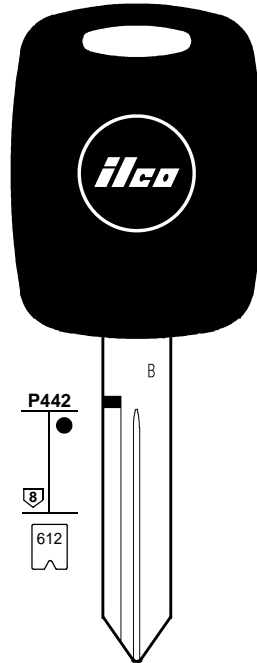

**H72-EK3**  
..... X  
1-1706

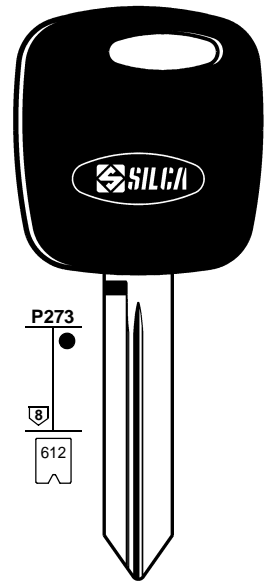

**FO38RT3**  
..... X  
0001-1706

**FO38RT17**  
..... X  
0001-1706

STRATTEC

1	2	2a	3	3a	3b	e1+e2		6	42+71	72	43+44a	12	15
						GTI COMPATIBLE		IGNITION					
CAR MAKE MODEL	FROM	TO	SILCA REF.	SILCA REF.	SILCA REF.	COPY	GEN.	TRANSP. TYPE	FAST COPY PLUS RW4 PLUS FAST COPY/RW4	FAST COPY PLUS RW4 PLUS	FAST COPY RW4	STP	
For more info on the uses of car keys, refer to the Silca Electronic Keys Catalogue:													
<b>MAZDA</b>													
323	1995	1997	MAZ13T5					TEMIC	12	Y	Y		
323	1997	1999	MAZ24RT5		MAZ24RFH			PH	33	Y	Y		
323	1997	1999	MAZ20REP										
323	1998	1999	MAZ24RT5		MAZ24RFH			TEMIC	12	Y	Y		
323	1999	2003						TEM / CR	8C				
626	1995	1999	MAZ20RT5					TEMIC	12	Y	Y		D
626	1999	2002						TEM / CR	8C				D
626 ( ES, LS, LUX )	1998	1999	MAZ24RT5		MAZ24RFH			PH	33	Y	Y		D
626 ( ES, LS, LUX )	1999	2002						TEM / CR	8C				
B-SERIES P/U	1999	2000	FO38RT3					TEXAS	4C				C
B-SERIES P/U	1999	2000	H72-EK3					TEXAS	4C	Y	Y		
B-SERIES P/U	2001	2006						TEX / CR	60				C
B-SERIES P/U	2007		FO38RT17					TEX / CR	63				
BT-50	2006							TEM / CR	8C				
CX-7	2007		MAZ24RT17					TEX / CR	63				
CX-7	2007		MAZ24RMH	MAZ24RTE	MAZ24RFH	Y	Y	TEX / CR	63	Y	P-BOX		
CX-7	2010		SMARTKEY					TEX / CR	63				
CX-9	2007		MAZ24RT17					TEX / CR	63				
CX-9	2007		MAZ24RMH	MAZ24RTE	MAZ24RFH	Y	Y	TEX / CR	63	Y	P-BOX		
CX-9	2010		SMARTKEY					TEX / CR	63				
DEMIO	1999	2002						TEM / CR	8C				
DEMIO [J]	2003		MAZ24RT17					TEX / CR	63				
DEMIO [J]	2003		MAZ24RMH	MAZ24RTE	MAZ24RFH	Y	Y	TEX / CR	63	Y	P-BOX		
MAZDA 2	2003		MAZ24RT17					TEX / CR	63				
MAZDA 2	2003		MAZ24RMH	MAZ24RTE	MAZ24RFH	Y	Y	TEX / CR	63	Y	P-BOX		
MAZDA 3	2004		MAZ24RT17					TEX / CR	63				
MAZDA 3	2004		MAZ24RMH	MAZ24RTE	MAZ24RFH	Y	Y	TEX / CR	63	Y	P-BOX		
MAZDA 3	2010		SMARTKEY					TEX / CR	63				
MAZDA 5	2005		MAZ24RT17					TEX / CR	63				
MAZDA 5	2005		MAZ24RMH	MAZ24RTE	MAZ24RFH	Y	Y	TEX / CR	63	Y	P-BOX		
MAZDA 6	2003		MAZ24RT17					TEX / CR	63				
MAZDA 6	2003		MAZ24RMH	MAZ24RTE	MAZ24RFH	Y	Y	TEX / CR	63	Y	P-BOX		
MAZDA 6	2009		SMARTKEY					TEX / CR	63				
MIATA	2001	2005						TEM / CR	8C				
MPV	2000	2006						TEM / CR	8C				
MX-3	1995	1998	MAZ13T5					TEMIC	12	Y	Y		
MX-5	1995	1998	MAZ13T5					TEMIC	12	Y	Y		
MX-5	1998	2000	MAZ24RT5		MAZ24RFH			PH	33	Y	Y		
MX-5	2000	2005						TEM / CR	8C				
MX-5	2005		MAZ24RT17					TEX / CR	63				
MX-5	2005		MAZ24RMH	MAZ24RTE	MAZ24RFH	Y	Y	TEX / CR	63	Y	P-BOX		
MX-5	2009		SMARTKEY					TEX / CR	63				
MX-6	1995	1997	MAZ20RT5					TEMIC	12	Y	Y		
PREMACY	2000	2004						TEM / CR	8C				
RX-8	2004		MAZ24RT17					TEX / CR	63				
RX-8	2004		MAZ24RMH	MAZ24RTE	MAZ24RFH	Y	Y	TEX / CR	63	Y	P-BOX		

FOR:  
PER:

# MAZDA

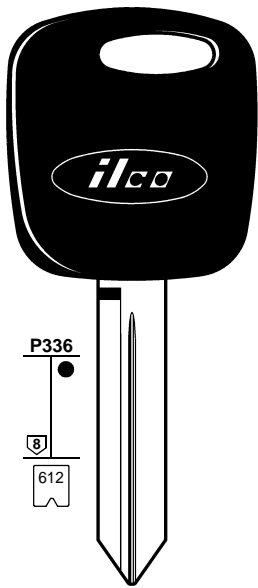

**H86-PT**  
.....X  
0001-1706

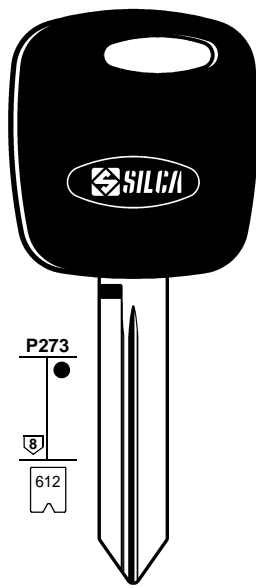

**FO38RT17**  
.....X  
0001-1706

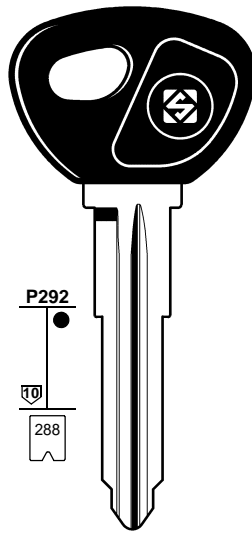

**MAZ20RT5**  
..... 10100-12283

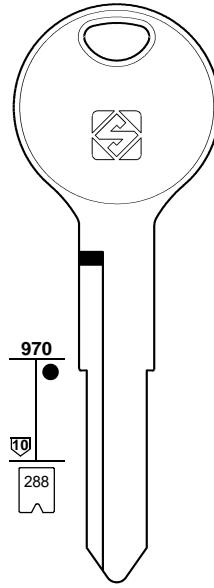

**MAZ25R**  
..... 10100-12283



**MIT14BT5**  
..... 30001-31200

STRATTEC

FOR:  
PER:

# MERCEDES

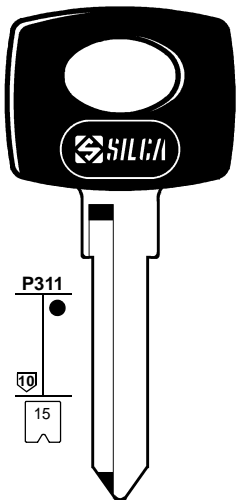

**YM15P**  
HM ..... 1-1200  
HM ..... 4001-7350  
HM ..... 2501-3500  
NM ..... 2501-3500  
.. NF .. 1-99 .. 1-99  
NF ..... 1-1200

VALEO - YMOS

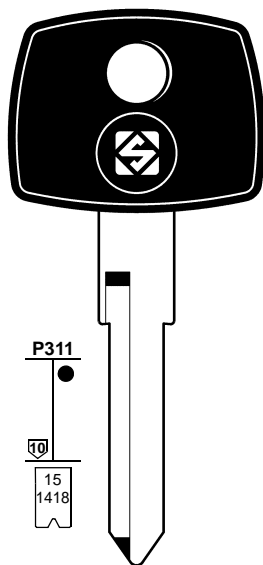

**YM15T5**  
HM ..... 1-1200  
HM ..... 2501-3500  
HM ..... 4001-7350  
HM ..... 6001-7109  
NM ..... 2501-3500  
.. NF .. 1-99 .. 1-99  
NF ..... 1-1200

VALEO - YMOS

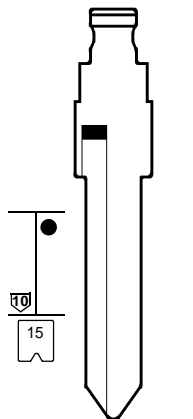

**YM15FH**  
HM ..... 1-1200  
HM ..... 4001-7350  
HM ..... 2501-3500  
NM ..... 2501-3500  
.. NF .. 1-99 .. 1-99  
NF ..... 1-1200

**VA5T5**  
HM ..... 1-1200  
HM ..... 4001-7350  
HM ..... 2501-3500  
NM ..... 2501-3500  
.. NF .. 1-99 .. 1-99  
NF ..... 1-1200

WITTE

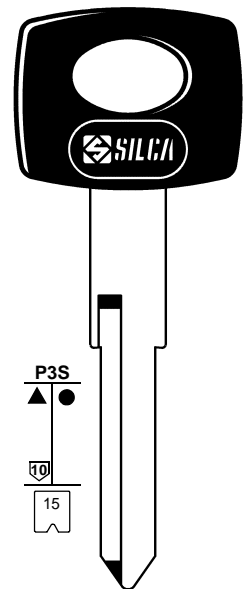

**HU72RP**  
HM ..... 1-1200  
HM ..... 4001-7350  
HM ..... 2501-3500  
NM ..... 2501-3500  
.. NF .. 1-99 .. 1-99  
NF ..... 1-1200

WITTE









FOR:  
PER:

# MERCURY

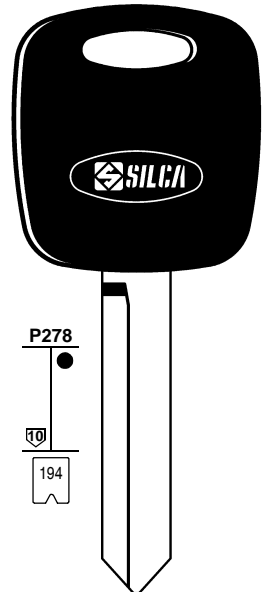
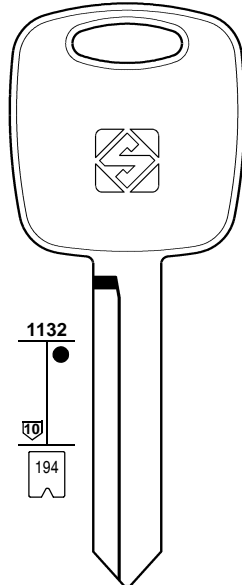
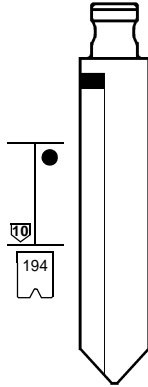
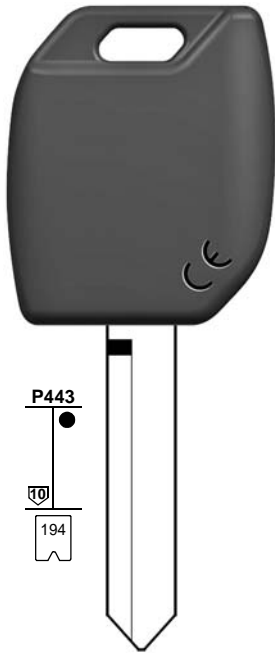

- ... A ... 101-381.501-579
- ... B ... 101-410.501-602
- ... C ... 101-404.501-624
- ... D ... 101-340.501-602
- ... E ... 101-304.501-579



**FO26TE**



**FO26T3**

STRATTEC



**FO26MH**

- ... A ... 101-381.501-579
- ... B ... 101-410.501-602
- ... C ... 101-404.501-624
- ... D ... 101-340.501-602
- ... E ... 101-304.501-579



**FO26FH**

- ... A ... 101-381.501-579
- ... B ... 101-410.501-602
- ... C ... 101-404.501-624
- ... D ... 101-340.501-602
- ... E ... 101-304.501-579



**FO39**

- ... A ... 101-381.501-579
- ... B ... 101-410.501-602
- ... C ... 101-404.501-624
- ... D ... 101-340.501-602
- ... E ... 101-304.501-579



**FO39CP**

- ... A ... 101-381.501-579
- ... B ... 101-410.501-602
- ... C ... 101-404.501-624
- ... D ... 101-340.501-602
- ... E ... 101-304.501-579

STRATTEC

STRATTEC

FOR:  
PER:

# MERCURY

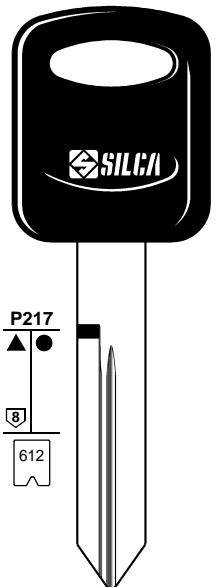
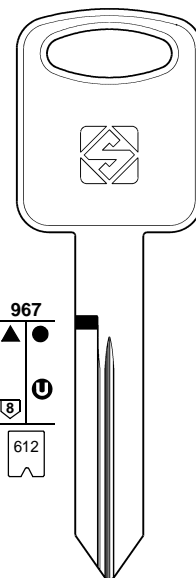
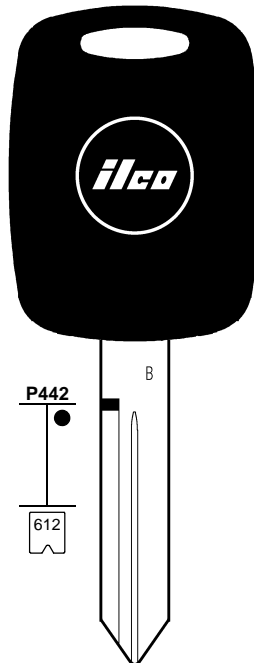
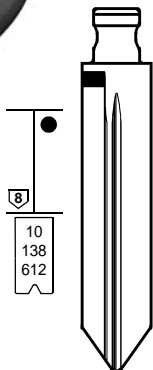
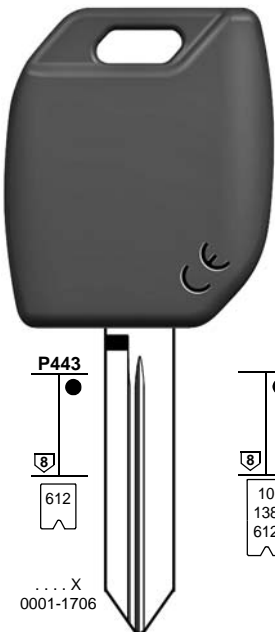
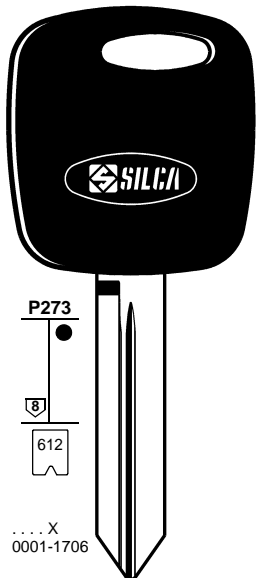

- ... X 0001-1706

- ... X 0001-1706

- ... A ... 101-381.501-579
- ... B ... 101-410.501-602
- ... C ... 101-404.501-624
- ... D ... 101-340.501-602
- ... E ... 101-304.501-579
- ... X 1-1706

- ... X 1-1706

- ... X 1-1706
- ... Y 1-1200

- ... X 1-1706
- ... Y 1-1200



**FO38RTE**



**FO38RT3**



**FO38RT17**

STRATTEC



**FO38RMH**



**FO38RFH**



**H72-EK3**

STRATTEC



**FO40R**

STRATTEC



**FO40RBP**



FOR: PER:	MG	MICROCAR (MICROCARS)	MITSUBISHI
--------------	----	----------------------	------------

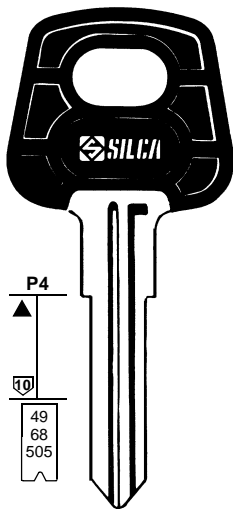

**NE38P**

FH . . . . 1-2000  
 E . . . . 2001-3000  
 S . . . . 2001-3000  
 NSP . . . . 4000-4999  
 E . . . . 4001-5000  
 E . . . . 5000-5999  
 E . . . . 6001-7000  
 NSP . . . . 7001-9000

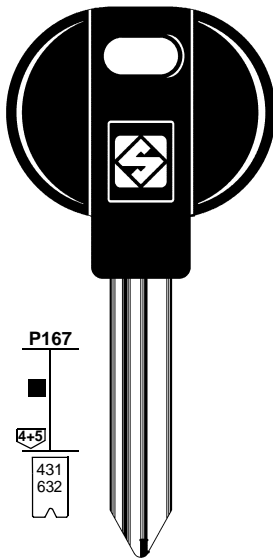

**SX9AP**

63/99 . . . . H 12468  
 63/99 . . . . 12468  
 . . . . . H 0111111-6288888  
 . . . . . 0111111-6288888

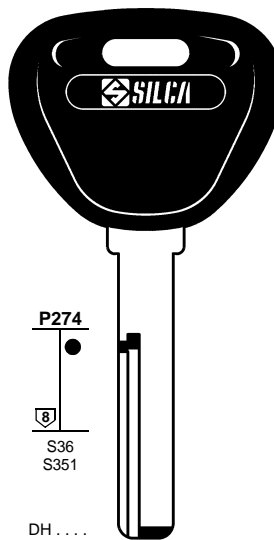

**HU56RT2**

DH . . . .  
 1-4000  
 6001-8000

**HU56RT30**

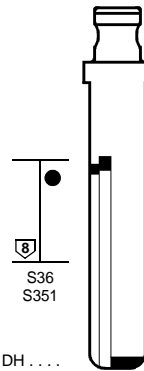

**HU56RFH**

DH . . . .  
 1-4000  
 6001-8000

FOR: PER:	MITSUBISHI		
--------------	------------	--	--

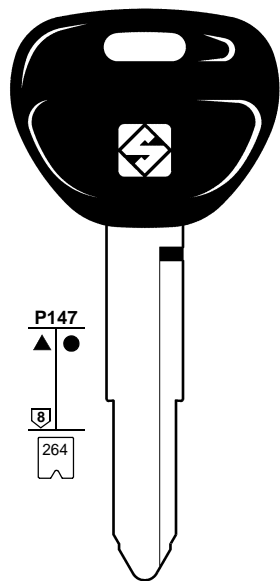

**MIT15AP**

E . . . . 5001-7000  
 E . . . . 7001-7700

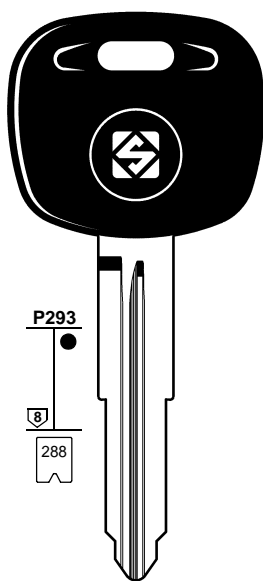

**MIT11RTE**

. . . . . 30010-32009



**MIT11RMH**

. . . . . 30010-32009

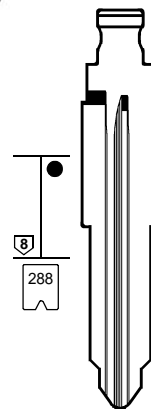

**MIT11RFH**

. . . . . 30010-32009

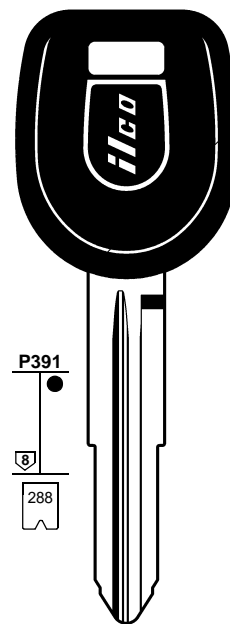

**MIT8-PT**

E . . . . 5001-7000  
 E . . . . 7001-7700



FOR:  
PER:

# MITSUBISHI

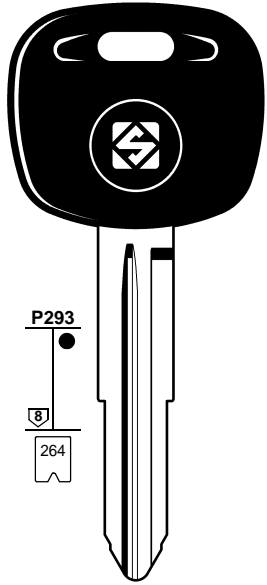

**MIT8T4**  
E . . . . 5001-7000  
E . . . . 7001-7700

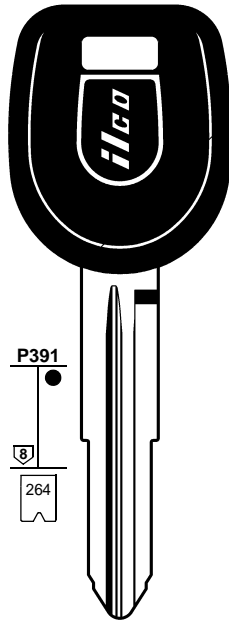

**MIT8T21**  
E . . . . 5001-7000  
E . . . . 7001-7700



**MIT8MH**  
E . . . . 5001-7000  
E . . . . 7001-7700

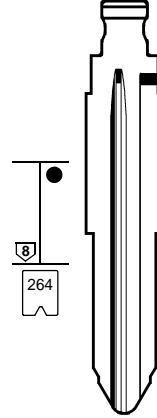

**MIT8FH**  
E . . . . 5001-7000  
E . . . . 7001-7700

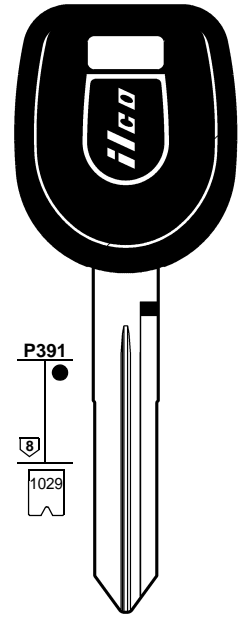

**MIT9-PT**  
F . . . . 1-1571

**MIT8TE**  
E . . . . 5001-7000  
E . . . . 7001-7700

**MIT8T19**  
E . . . . 5001-7000  
E . . . . 7001-7700

FOR:  
PER:

# MITSUBISHI

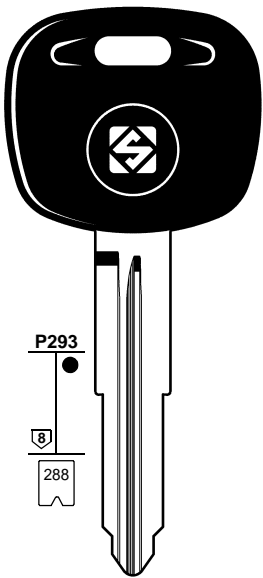

**MIT11RT4**  
. . . . . 30010-32009

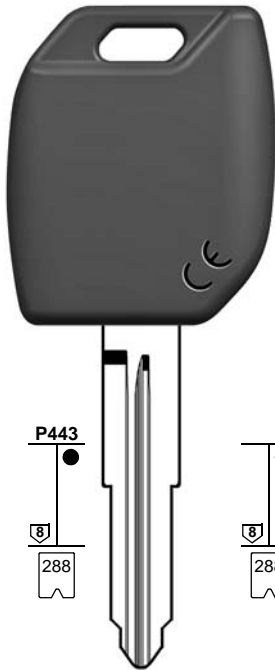

**MIT11RMH**  
. . . . . 30010-32009

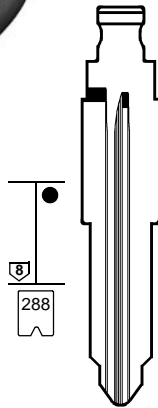

**MIT11RFH**  
. . . . . 30010-32009

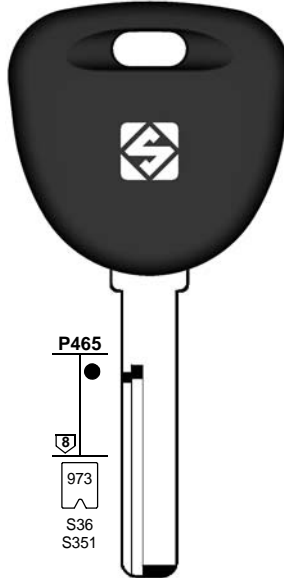

**HU56RTE**  
DH . . . .  
1-4000  
6001-8000

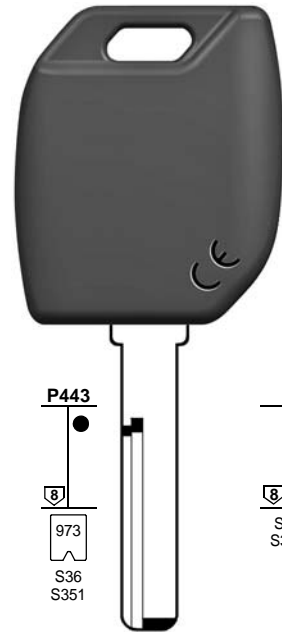

**HU56RMH**  
DH . . . .  
1-4000  
6001-8000

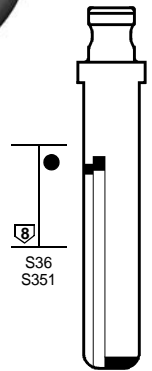

**HU56RFH**  
DH . . . .  
1-4000  
6001-8000





FOR:  
PER:

# MITSUBISHI

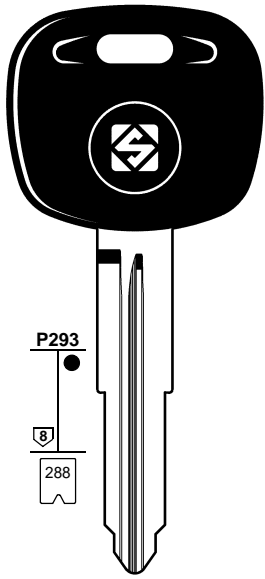

P293

288



**MIT11RTE**

..... 30010-32009

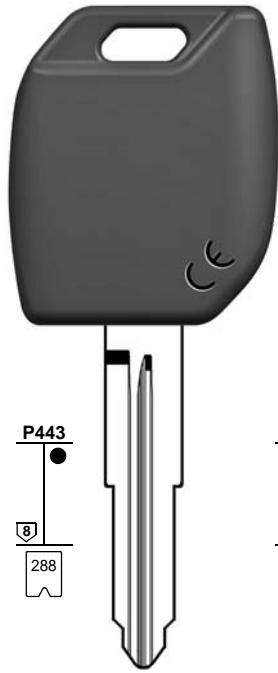

P443

288



**MIT11RMH**

..... 30010-32009

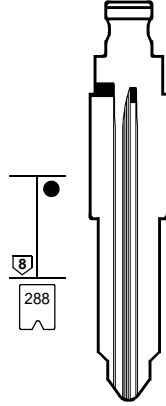

P288

288



**MIT11RFH**

..... 30010-32009

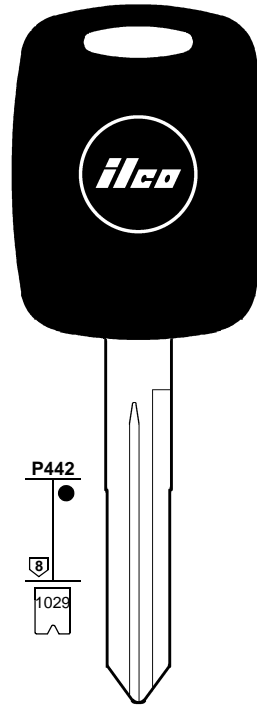

P442

1029



**EK3P-MIT16**

F..... 1-1571

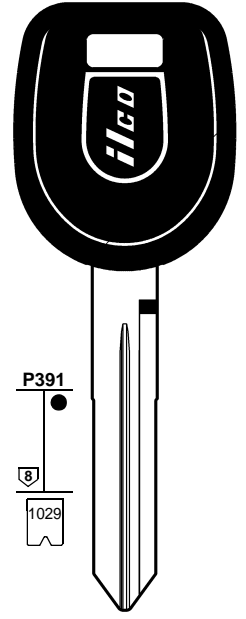

P391

1029



**MIT9-PT**

F..... 1-1571



**MIT11RT4**

..... 30010-32009



**MIT11RT19**

..... 30010-32009

FOR:  
PER:

# MITSUBISHI

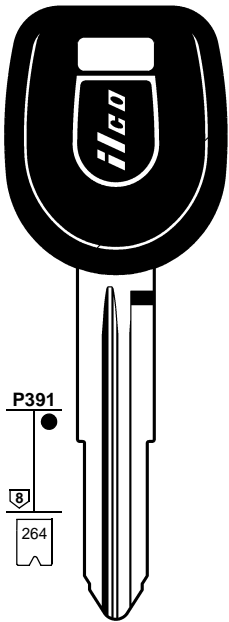

P391

264



**MIT8-PT**

E..... 5001-7000  
E..... 7001-7700

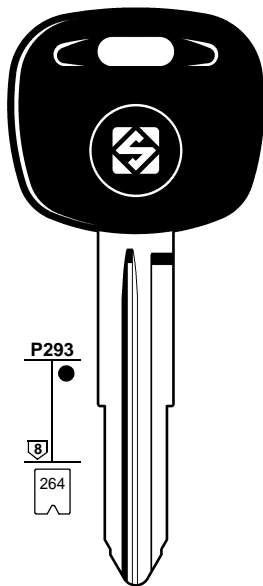

P293

264



**MIT8T4**

E..... 5001-7000  
E..... 7001-7700



P443

264



**MIT8MH**

E..... 5001-7000  
E..... 7001-7700

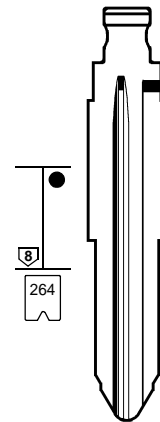

264



**MIT8FH**

E..... 5001-7000  
E..... 7001-7700

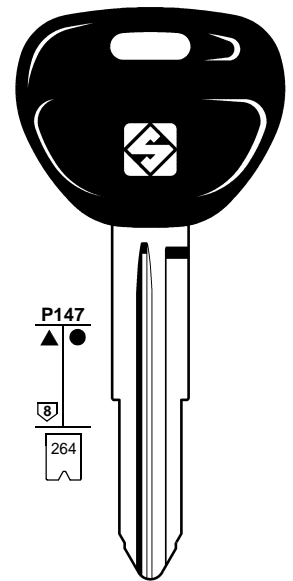

P147

264



**MIT8AP**

E..... 5001-7000  
E..... 7001-7700



**MIT8TE**

E..... 5001-7000  
E..... 7001-7700



**MIT8T19**

E..... 5001-7000  
E..... 7001-7700

1	2	2a	3	3a	3b	e1+e2		6	42+71	72	43+44a	12	15
						GTI COMPATIBLE		IGNITION					
CAR MAKE MODEL	FROM	TO	SILCA REF.	SILCA REF.	SILCA REF.	COPY	GEN.	TRANSP. TYPE	FAST COPY PLUS RW4 PLUS FAST COPY/RW4	FAST COPY PLUS RW4 PLUS	FAST COPY RW4	STP	
For more info on the uses of car keys, refer to the Silca Electronic Keys Catalogue:													
<b>MITSUBISHI</b>													
ECLIPSE	2006	2007	EK3P-MIT16					PH / CR2	46	Y	P-BOX		
ECLIPSE	2008	2012						PH / CR2	46				
ECLIPSE	2008	2012	MIT11RMH	MIT11RTE	MIT11RFH	Y	Y	PH / CR2	46	Y	P-BOX		
ENDEAVOR	2001	2005						TEX / CR	61				
ENDEAVOR	2006	2007						PH / CR2	46				
ENDEAVOR	2006	2007	EK3P-MIT16					PH / CR2	46	Y	P-BOX		
ENDEAVOR	2007	2011	MIT11RMH	MIT11RTE	MIT11RFH	Y	Y	PH / CR2	46	Y	P-BOX		
ENDEAVOR	2007	2011						PH / CR2	46				
EXPRESS	1996		MIT8T4					TEXAS	4C				
EXPRESS	1996		MIT8MH	MIT8TE	MIT8FH	Y	Y	TEXAS	4C	Y	P-BOX		
FOCUS	1998		MIT8T4					TEXAS	4C				
FOCUS	1998		MIT8MH	MIT8TE	MIT8FH	Y	Y	TEXAS	4C	Y	P-BOX		
GALANT	1996	2000	MIT8T4					TEXAS	4C				
GALANT	1996	2000	MIT8MH	MIT8TE	MIT8FH	Y	Y	TEXAS	4C	Y	P-BOX		
GALANT	2000	2002	MIT9-PT					TEX / CR	64				
GALANT	2002	2005	MIT8T19					TEX / CR	61				
GALANT	2002	2005	MIT8MH	MIT8TE	MIT8FH	Y	Y	TEX / CR	61	Y	P-BOX		
GALANT	2006		MIT11RMH	MIT11RTE	MIT11RFH	Y	Y	PH / CR2	46	Y	P-BOX		
GALANT	2006							PH / CR2	46				
GALANT (USA)	2002	2003						TEX / CR	61				
GALANT (USA)	2004	2007						PH / CR2	46				
GALANT (USA)	2004	2007	EK3P-MIT16					PH / CR2	46	Y	P-BOX		
GALANT (USA)	2008	2012	MIT11RMH	MIT11RTE	MIT11RFH	Y	Y	PH / CR2	46	Y	P-BOX		
GALANT (USA)	2008	2012						PH / CR2	46				
GRANDIS	2003							PH / CR2	46				
GRANDIS	2003		MIT11RMH	MIT11RTE	MIT11RFH	Y	Y	PH / CR2	46	Y	P-BOX		
I-MIEV	2010							PH / CR2	46				
I-MIEV	2010		MIT11RMH	MIT11RTE	MIT11RFH	Y	Y	PH / CR2	46	Y	P-BOX		
LANCER	1996	2003	MIT11RT4					TEXAS	4C				
LANCER	1996	2003	MIT11RMH	MIT11RTE	MIT11RFH	Y	Y	TEXAS	4C	Y	P-BOX		
LANCER	2003	2006	MIT11RT19					TEX / CR	61				
LANCER	2003	2006	MIT11RMH	MIT11RTE	MIT11RFH	Y	Y	TEX / CR	61	Y	P-BOX		
LANCER	2006							PH / CR2	46				
LANCER	2006		MIT11RMH	MIT11RTE	MIT11RFH	Y	Y	PH / CR2	46	Y	P-BOX		
LANCER EVO	2003	2006	MIT11RT19					TEX / CR	61				
LANCER SW	1996	2003	MIT11RT4					TEXAS	4C				
LANCER SW	1996	2003	MIT11RMH	MIT11RTE	MIT11RFH	Y	Y	TEXAS	4C	Y	P-BOX		
L200	1999	2002	MIT8-PT					TEX / CR	60				
L200	2002	2006	MIT8MH	MIT8TE	MIT8FH	Y	Y	TEX / CR	61	Y	P-BOX		
L200	2003	2006	MIT8T19					TEX / CR	61				
L200	2006							PH / CR2	46				
L200	2006		MIT8MH	MIT8TE	MIT8FH	Y	Y	PH / CR2	46	Y	P-BOX		
L400	1997		MIT8AP										

FOR:  
PER:

# MITSUBISHI

**P322**  
S232  
S24

**P443**  
480  
S24  
S232  
S765  
S819  
S853  
S1001  
S1122  
S1150  
S1356

**P322**  
480  
S24  
S232  
S765  
S819  
S853  
S1001  
S1122  
S1150  
S1356

**P322**  
S765

**P391**  
264

**P293**  
264

**TOY40BTE** (TE KEY)  
..... 1-5000

**TOY40MH** (MH KEY)  
..... 1-5000  
L..... 0001-1000  
G..... 0001-2500  
J..... 0001-2500  
K..... 0001-2500  
P..... 0001-2500  
..... 30001-31200

**TOY40FH** (FH FLIP)  
..... 1-5000  
L..... 0001-1000  
J..... 0001-2500

**MIT14BT5**  
..... 30001-31200

**MIT14BT14**  
..... 30001-31200

**MIT8-PT**  
E..... 5001-7000  
E..... 7001-7700

**MIT8T4**  
E..... 5001-7000  
E..... 7001-7700

**MIT8T21**  
E..... 5001-7000  
E..... 7001-7700

**MIT8TE** (TE KEY)  
E..... 5001-7000  
E..... 7001-7700

**MIT8T19**  
E..... 5001-7000  
E..... 7001-7700

FOR:  
PER:

# MITSUBISHI

**P443**  
264

**P293**  
288

**P443**  
288

**P443**  
288

**MIT8MH** (MH KEY)  
E..... 5001-7000  
E..... 7001-7700

**MIT8FH** (FH FLIP)  
E..... 5001-7000  
E..... 7001-7700

**MIT11RTE** (TE KEY)  
..... 30010-32009

















**MIT11RT4**  
..... 30010-32009

**MIT11RMH** (MH KEY)  
..... 30010-32009

**MIT11RFH** (FH FLIP)  
..... 30010-32009

**MIT11RT19**  
..... 30010-32009

**MIT11RT21**  
..... 30010-32009

1	2	2a	3	3a	3b	e1+e2		6	42+71	72	43+44a	12	15
						GTI COMPATIBLE		IGNITION 					
CAR MAKE MODEL	FROM	TO	SILCA REF.	SILCA REF.	SILCA REF.	COPY	GEN.	TRANSP. TYPE	FAST COPY PLUS RW4 PLUS FAST COPY/RW4	FAST COPY PLUS RW4 PLUS	FAST COPY RW4	STP	
													
For more info on the uses of car keys, refer to the Silca Electronic Keys Catalogue: 													
<b>MITSUBISHI</b>													
MAGNA	1996	1999	MIT14BT5					PH	73	Y	Y		
MAGNA	1999	2005	MIT14BT14					PH / CR2	46				
MAGNA	1999	2005	TOY40MH	TOY40BTE	TOY40FH	Y	Y	PH / CR2	46	Y	P-BOX		
MIRAGE	1996	2002	MIT11RMH	MIT11RTE	MIT11RFH	Y	Y	TEXAS	4C	Y	P-BOX		
MIRAGE	1996	2002	MIT11RT4					TEXAS	4C				
MONTERO	1996	2000	MIT8T4					TEXAS	4C				
MONTERO	1996	2000	MIT8MH	MIT8TE	MIT8FH	Y	Y	TEXAS	4C	Y	P-BOX		
MONTERO	2001	2006	MIT8-PT					TEX / CR	60				
MONTERO	2001	2006	MIT8MH	MIT8TE	MIT8FH	Y	Y	TEX / CR	60	Y	P-BOX		
MONTERO	2002	2005	MIT8T19					TEX / CR	61				
MONTERO	2002	2003	MIT8T21					TEX / CR	62				
MONTERO	2002	2005	MIT8MH	MIT8TE	MIT8FH	Y	Y	TEX / CR	61	Y	P-BOX		
MONTERO	2002	2003	MIT8MH	MIT8TE	MIT8FH	Y	Y	TEX / CR	62	Y	P-BOX		
MONTERO IO	2000	2006	MIT11RT19					TEX / CR	61				
MONTERO IO	2000	2006	MIT11RMH	MIT11RTE	MIT11RFH	Y	Y	TEX / CR	61	Y	P-BOX		
MONTERO SPORT	2000	2002	MIT8MH	MIT8TE	MIT8FH	Y	Y	TEX / CR	60	Y	P-BOX		
MONTERO SPORT	2000	2002	MIT8-PT					TEX / CR	60				
MONTERO SPORT	2001	2004	MIT8T21					TEX / CR	62				
MONTERO SPORT	2001	2004	MIT8MH	MIT8TE	MIT8FH	Y	Y	TEX / CR	62	Y	P-BOX		
MONTERO SPORT	2002	2005	MIT8T19					TEX / CR	61				
MONTERO SPORT	2002	2005	MIT8MH	MIT8TE	MIT8FH	Y	Y	TEX / CR	61	Y	P-BOX		
NATIVA	2001	2002	MIT8-PT					TEX / CR	60				
NIMBUS	1998	1999	MIT8T4					TEXAS	4C				
NIMBUS	1998	1999	MIT8MH	MIT8TE	MIT8FH	Y	Y	TEXAS	4C	Y	P-BOX		
NIMBUS	1999	2002						TEX / CR	60				
OUTLANDER	2000	2003	MIT8-PT					TEX / CR	60				
OUTLANDER	2000	2003	MIT8MH	MIT8TE	MIT8FH	Y	Y	TEX / CR	60	Y	P-BOX		
OUTLANDER	2004	2006	MIT11RT19					TEX / CR	61				
OUTLANDER	2004	2006	MIT11RMH	MIT11RTE	MIT11RFH	Y	Y	TEX / CR	61	Y	P-BOX		
OUTLANDER	2006							PH / CR2	46				
OUTLANDER	2006		MIT11RMH	MIT11RTE	MIT11RFH	Y	Y	PH / CR2	46	Y	P-BOX		
PAJERO	1996	2000	MIT8T4					TEXAS	4C				
PAJERO	1996	2000	MIT8MH	MIT8TE	MIT8FH	Y	Y	TEXAS	4C	Y	P-BOX		
PAJERO	2000	2002	MIT8-PT					TEX / CR	60				
PAJERO	2000	2002	MIT8MH	MIT8TE	MIT8FH	Y	Y	TEX / CR	60	Y	P-BOX		
PAJERO	2002	2005	MIT8T19					TEX / CR	61				
PAJERO	2002	2003	MIT8T21					TEX / CR	62				
PAJERO	2002	2003	MIT8MH	MIT8TE	MIT8FH	Y	Y	TEX / CR	62	Y	P-BOX		
PAJERO	2002	2005	MIT8MH	MIT8TE	MIT8FH	Y	Y	TEX / CR	61	Y	P-BOX		
PAJERO	2006							PH / CR2	46				
PAJERO	2006		MIT8MH	MIT8TE	MIT8FH	Y	Y	PH / CR2	46	Y	P-BOX		
PAJERO IO	1999	2004	MIT11RT19					TEX / CR	61				
PAJERO IO	1999	2004	MIT11RMH	MIT11RTE	MIT11RFH	Y	Y	TEX / CR	61	Y	P-BOX		
PAJERO MINI [J]	1999		MIT11RT21					TEX / CR	62				
PAJERO MINI [J]	1999		MIT11RMH	MIT11RTE	MIT11RFH	Y	Y	TEX / CR	62	Y	P-BOX		
PAJERO PININ	1999	2004	MIT11RT21					TEX / CR	62				

FOR:  
PER:

# MITSUBISHI

**P337**  
537  
745

**P462**  
537  
745

**P443**  
537  
745

**P391**  
264

**P293**  
264

**Y164-PT**  
L . . . . 1-3580  
M . . . . 1-2618

**CY24TE**  
L . . . . 1-3580  
M . . . . 1-2618

**CY24MH**  
L . . . . 1-3580  
M . . . . 1-2618

**CY24FH**  
L . . . . 1-3580  
M . . . . 1-2618  
FT . . . . 1001-3000

**MIT8-PT**  
E . . . . 5001-7000  
E . . . . 7001-7700

**MIT8T4**  
E . . . . 5001-7000  
E . . . . 7001-7700

**MIT8T21**  
E . . . . 5001-7000  
E . . . . 7001-7700

**MIT8TE**  
E . . . . 5001-7000  
E . . . . 7001-7700

**MIT8T19**  
E . . . . 5001-7000  
E . . . . 7001-7700

FOR:  
PER:

# MITSUBISHI

**P443**  
264

**P293**  
288

**P443**  
288

**P322**  
S765

**MIT8MH**  
E . . . . 5001-7000  
E . . . . 7001-7700

**MIT8FH**  
E . . . . 5001-7000  
E . . . . 7001-7700

**MIT11RTE**  
E . . . . 30010-32009

**MIT11RT4**  
E . . . . 30010-32009

**MIT11RMH**  
E . . . . 30010-32009

**MIT11RFH**  
E . . . . 30010-32009

**MIT14BT5**  
E . . . . 30001-31200











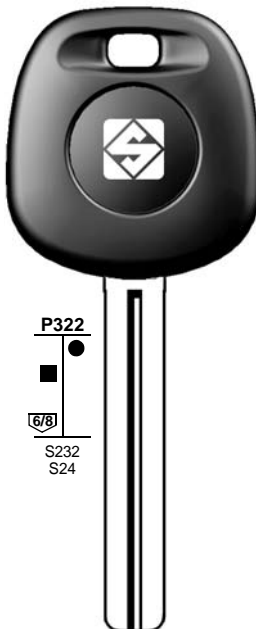
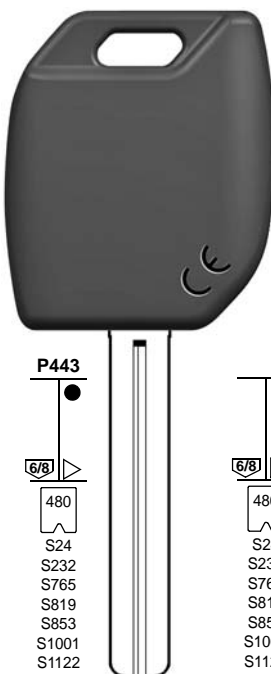

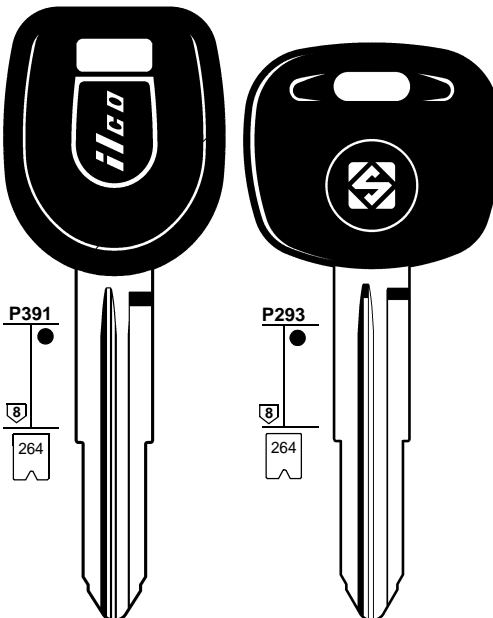
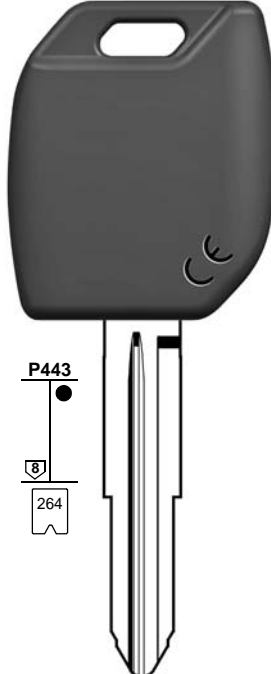
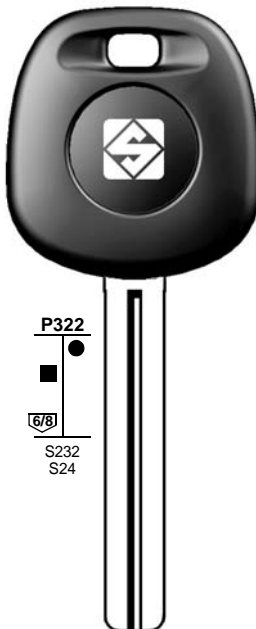
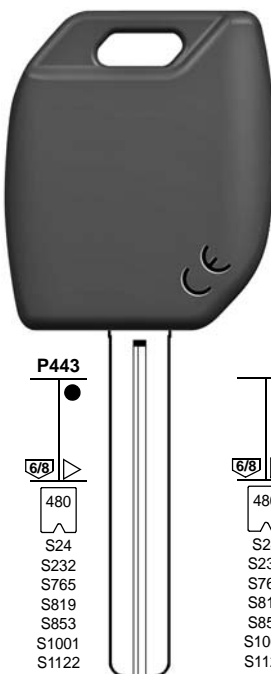

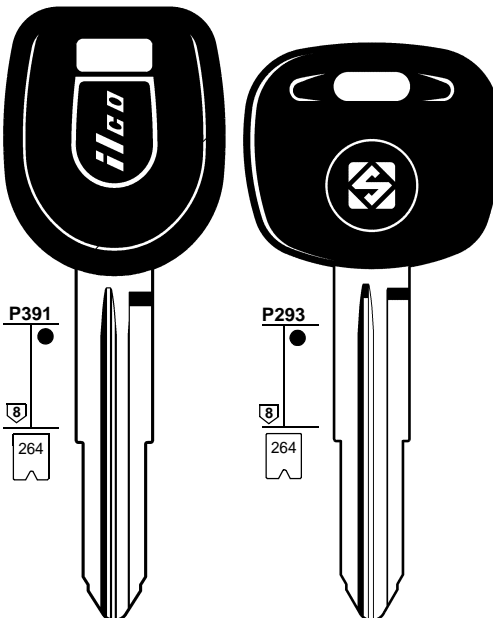
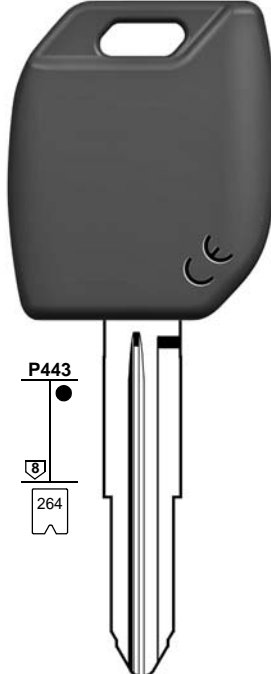
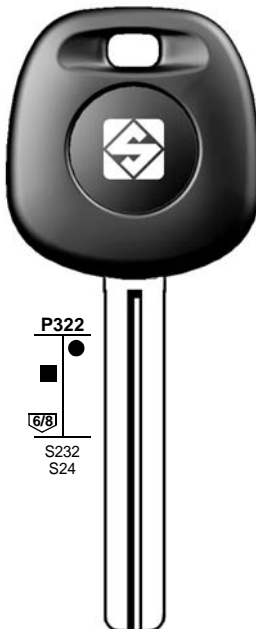
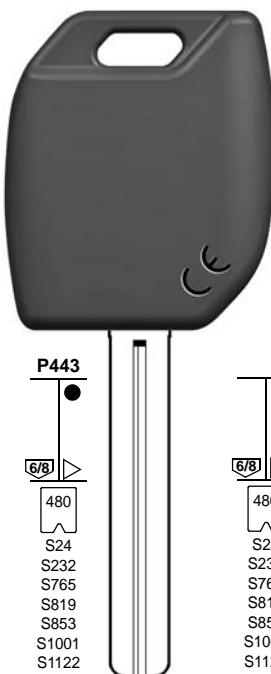

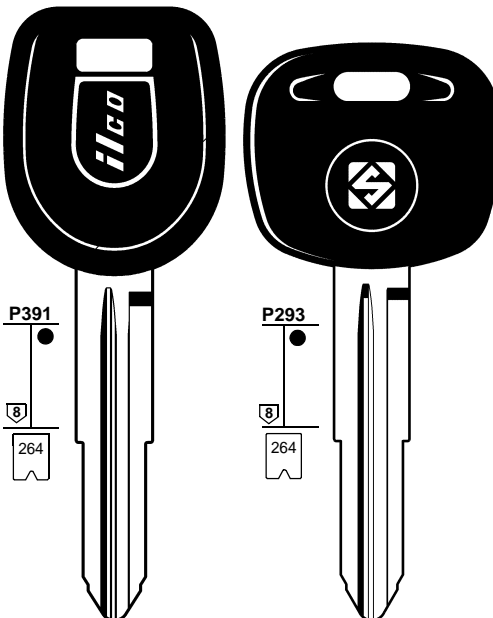
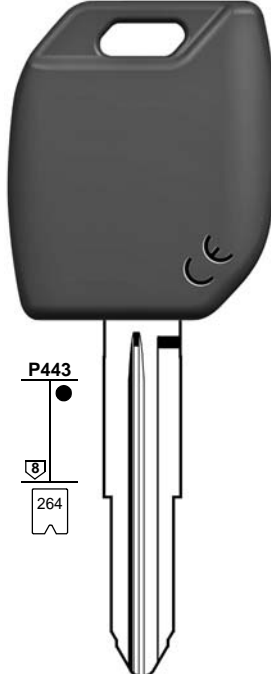
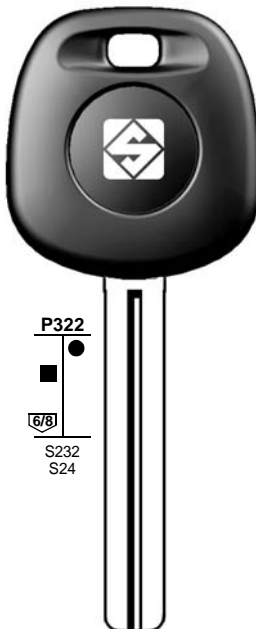
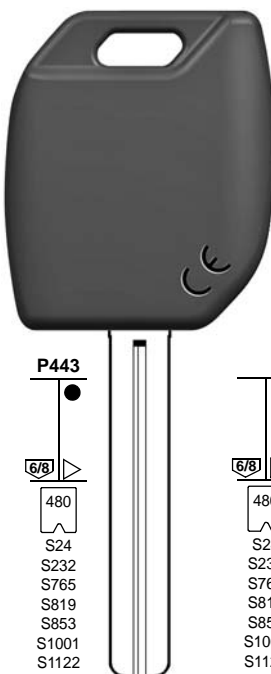

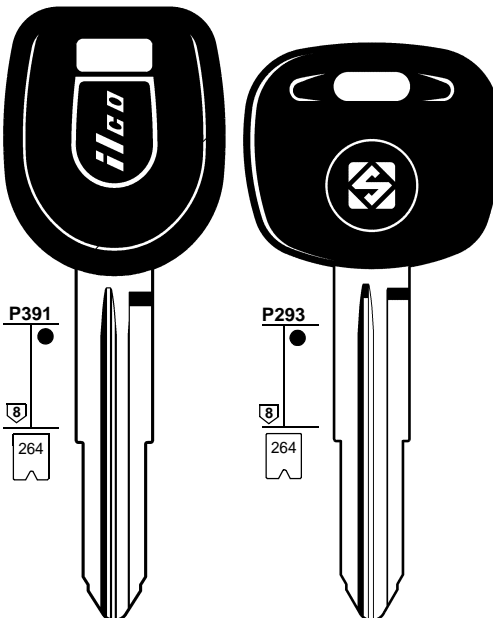
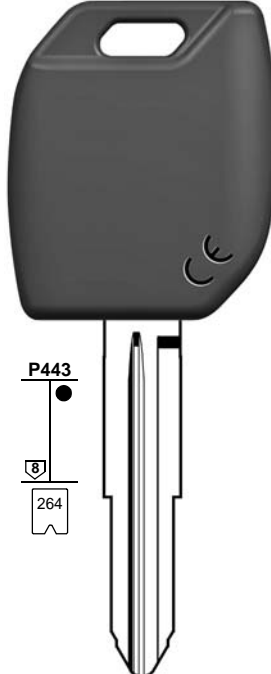
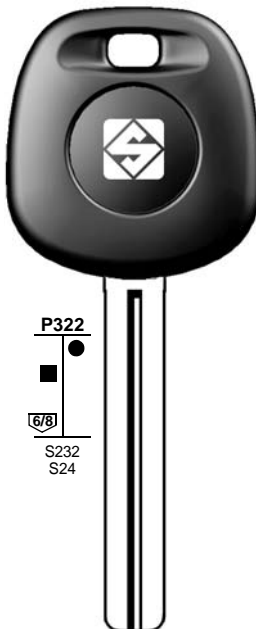
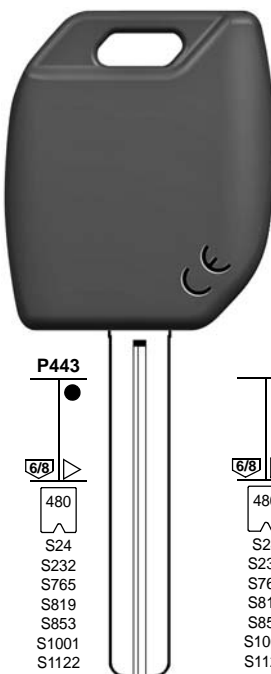

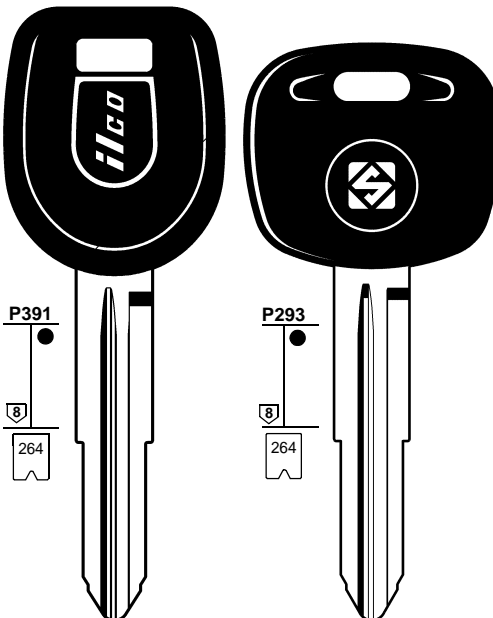
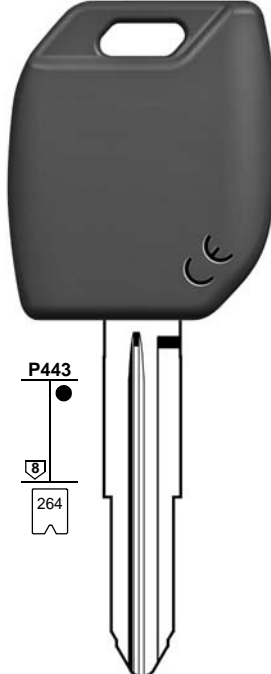
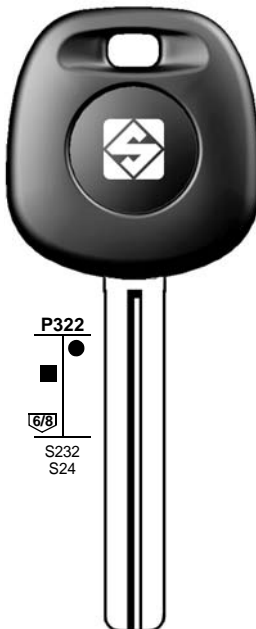
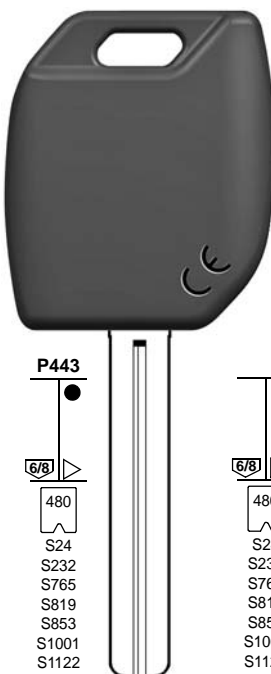
**MIT11RT19**  
E . . . . 30010-32009

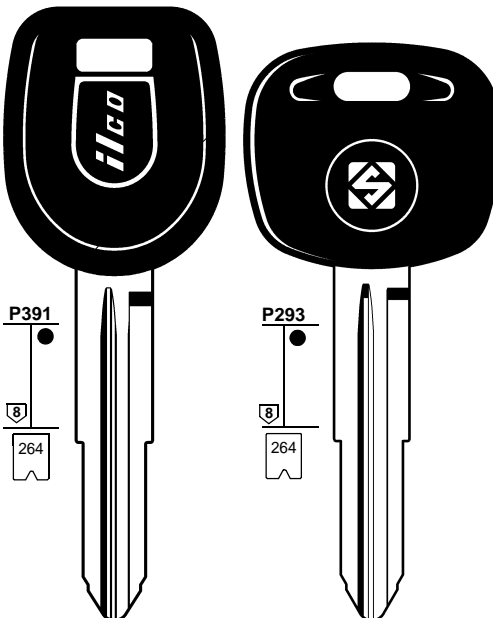
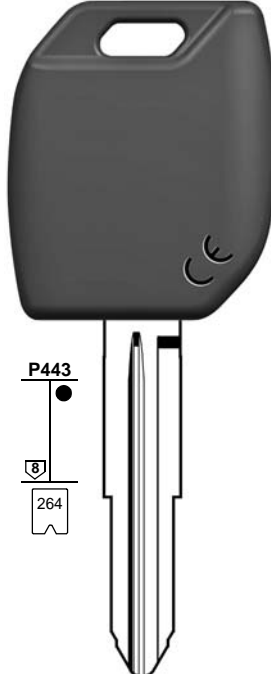
**MIT14BT14**  
E . . . . 30001-31200



FOR:  
PER:

# MITSUBISHI











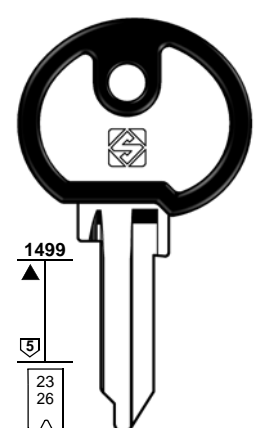
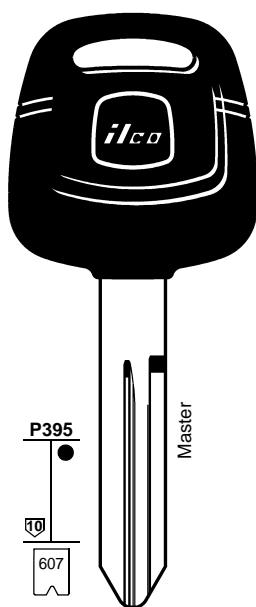
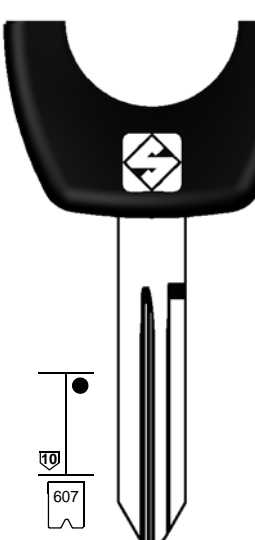

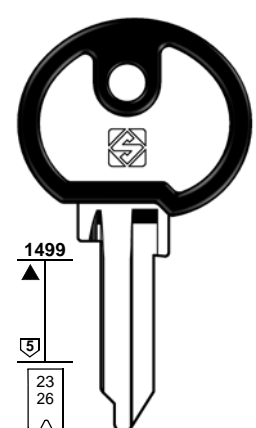
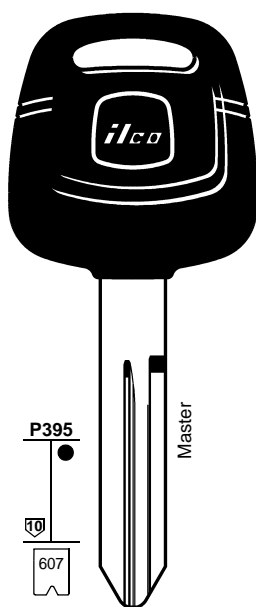
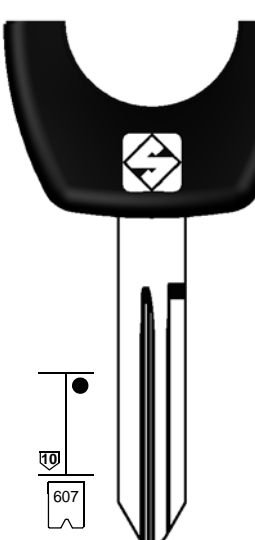
 <p>P322</p>  <p>P443</p>  <p>P391</p>  <p>P293</p>  <p>P443</p>	 <p>P322</p>  <p>P443</p>  <p>P391</p>  <p>P293</p>  <p>P443</p>	 <p>P322</p>  <p>P443</p>  <p>P391</p>  <p>P293</p>  <p>P443</p>	 <p>P322</p>  <p>P443</p>  <p>P391</p>  <p>P293</p>  <p>P443</p>	 <p>P322</p>  <p>P443</p>  <p>P391</p>  <p>P293</p>  <p>P443</p>	 <p>P322</p>  <p>P443</p>  <p>P391</p>  <p>P293</p>  <p>P443</p>
<p>6/8</p> <p>S232 S24</p>	<p>6/8</p> <p>480</p> <p>S24 S232 S765 S819 S853 S1001 S1122 S1150 S1356</p>	<p>6/8</p> <p>480</p> <p>S24 S232 S765 S819 S853 S1001 S1122 S1150 S1356</p>	<p>8</p> <p>264</p>	<p>8</p> <p>264</p>	<p>8</p> <p>264</p>
 <p><b>TOY40BTE</b> ..... 1-5000</p>	 <p><b>TOY40MH</b> ..... 1-5000 L..... 0001-1000 G..... 0001-2500 J..... 0001-2500 K..... 0001-2500 P..... 0001-2500 ..... 30001-31200</p>	 <p><b>TOY40FH</b> ..... 1-5000 L..... 0001-1000 J..... 0001-2500</p>	 <p><b>MIT8-PT</b> E..... 5001-7000 E..... 7001-7700</p>	 <p><b>MIT8T4</b> E..... 5001-7000 E..... 7001-7700</p>	 <p><b>MIT8T19</b> E..... 5001-7000 E..... 7001-7700</p>
			 <p><b>MIT8TE</b> E..... 5001-7000 E..... 7001-7700</p>		 <p><b>MIT8MH</b> E..... 5001-7000 E..... 7001-7700</p>

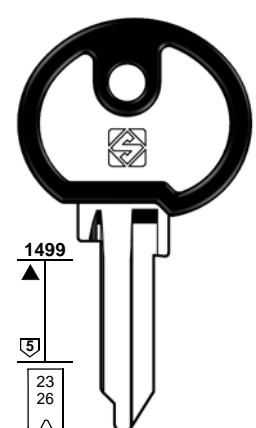
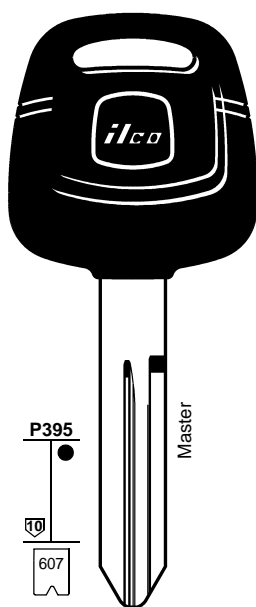
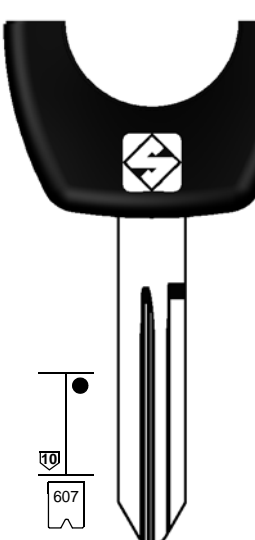
FOR:  
PER:

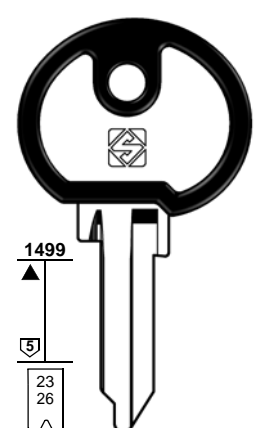
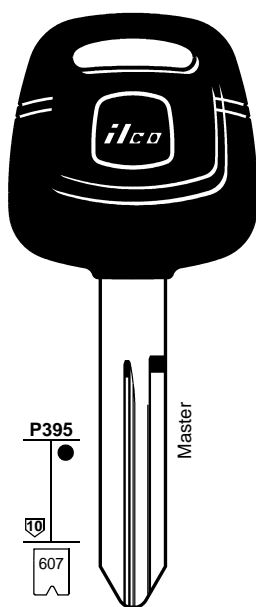
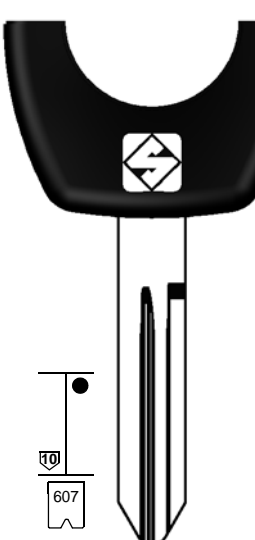
# MITSUBISHI

# MOSKVITCH

# NISSAN

 <p>P322</p>  <p>1499</p>  <p>P395</p>  <p>607</p>	 <p>P322</p>  <p>1499</p>  <p>P395</p>  <p>607</p>	 <p>P322</p>  <p>1499</p>  <p>P395</p>  <p>607</p>	 <p>P322</p>  <p>1499</p>  <p>P395</p>  <p>607</p>
<p>8</p> <p>S765</p>	<p>5</p> <p>23 26</p>	<p>10</p> <p>607</p>	<p>10</p> <p>607</p>
 <p><b>MIT14BT5</b> ..... 30001-31200</p>	 <p><b>NE20NP</b> ..... A/Z 04689 ..... A/Z 12357 A/Z ..... 12357 A/Z ..... A/Z 12357</p>	 <p><b>NI02T</b> ..... 1-22185</p>	 <p><b>NSN14AT25</b> ..... 1-22185</p>
 <p><b>MIT14BT14</b> ..... 30001-31200</p>			





FOR:  
PER:

# NISSAN

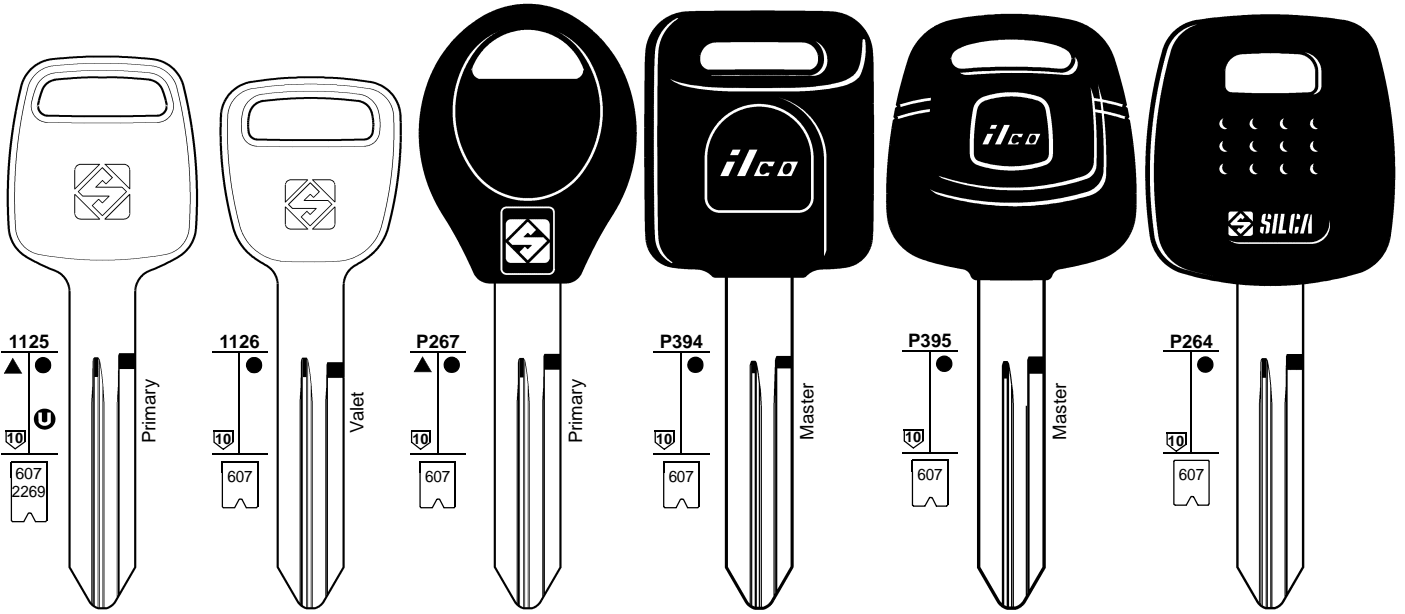

**NSN14**  
..... 1-22185

**NSN15**  
..... 1-22185

**NSN14CP**  
..... 1-22185

**NI01T**  
..... 1-22185

**NI02T**  
..... 1-22185

**NSN14T13**  
..... 1-22185

**NSN14T25**  
..... 1-22185

**NSN14TE**  
..... 1-22185  
..... 30001-37850

FOR:  
PER:

# NISSAN

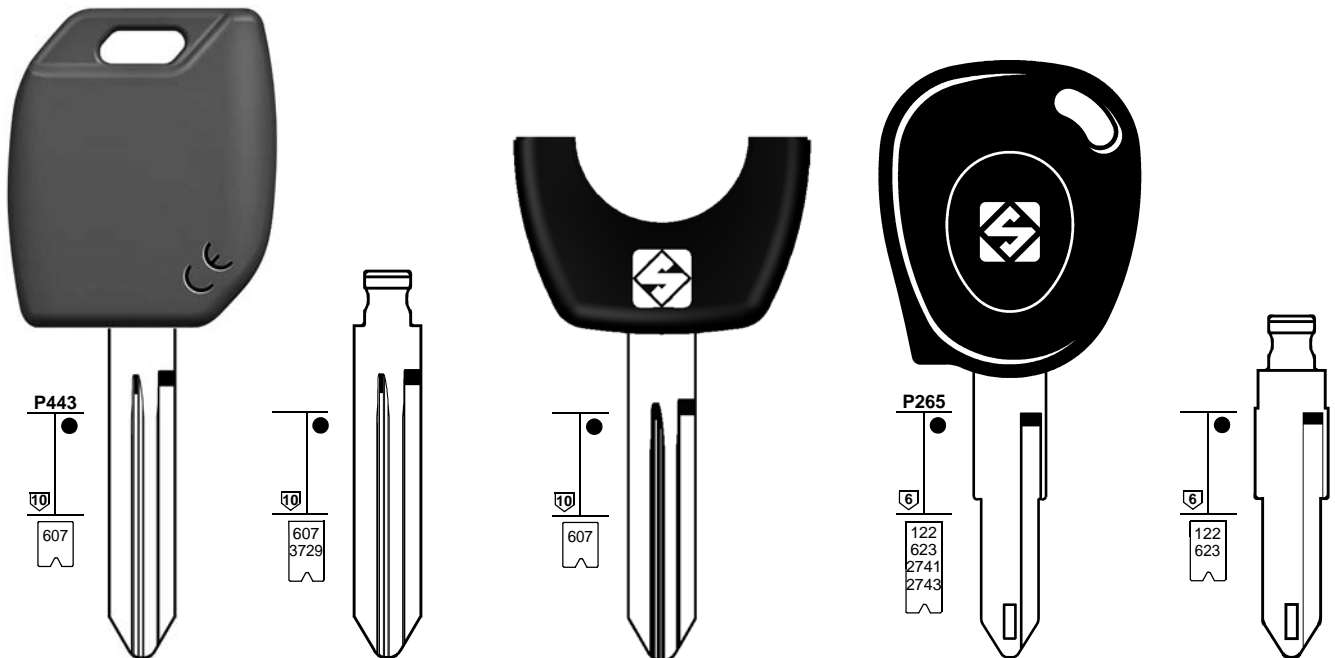

**NSN14MH**  
..... 1-22185  
..... 30001-37850

**NSN14FH**  
..... 1-22185

**NSN14AT13**  
..... 1-22185

**NE73T5**  
..... M-N-P-R-S

**NE73FH**  
..... M-N-P-R-S

**NE73T32**  
..... M-N-P-R-S

NEIMAN - VALEO



FOR:  
PER:

# NISSAN

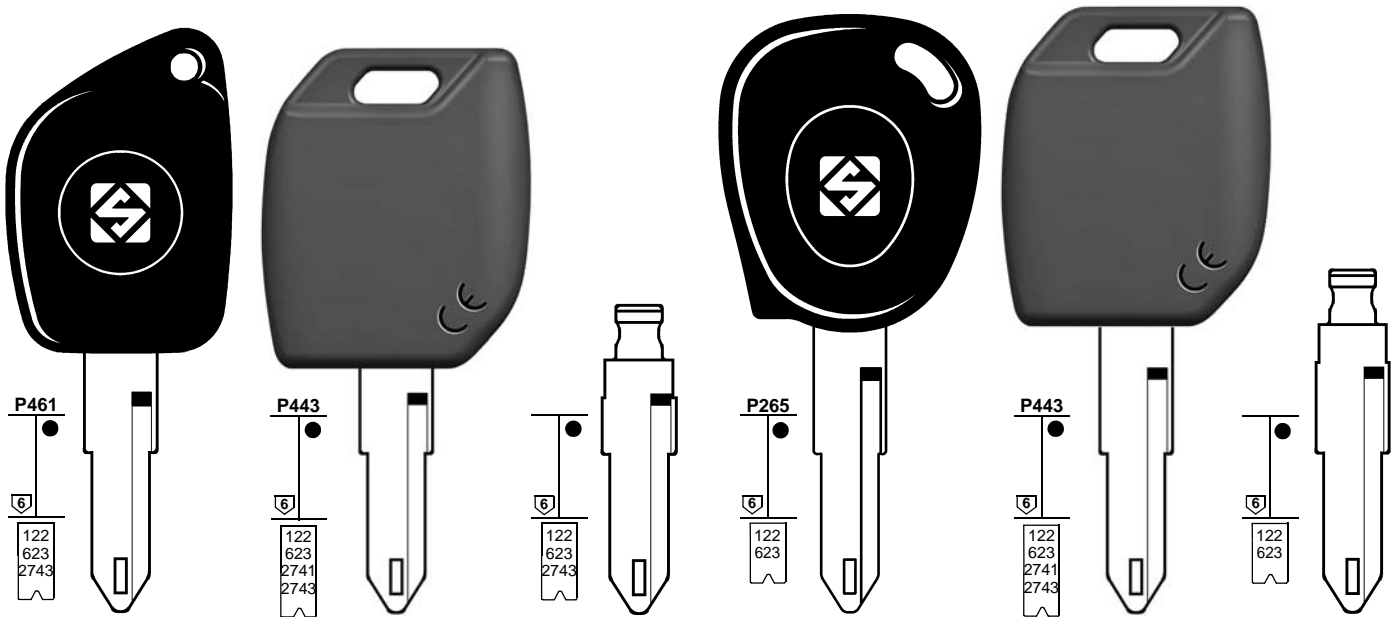

**NE72ATE**  
TE KEY

..... 1/9 . . . A/Z/A/Z MNPRS  
..... 0/90/9 MNPRS  
..... 1/9 . . . A/Z MNPRS  
..... 1/9 . . . A/Z MNPRS  
..... 1/9 . . . A/Z MNPRS  
..... 1/9 . . . A/Z/A/Z MNPRS  
..... 1/9 . . . A/Z MNPRS  
..... 1/9 . . . A/Z MNPRS  
..... 1/9 . . . A/Z MNPRS

**NE72MH**  
MH KEY

..... M-N-P-R-S  
..... 0/90/9 MNPRS  
..... 1/9 . . . A/Z MNPRS  
..... 1/9 . . . A/Z MNPRS  
..... 1/9 . . . A/Z MNPRS  
..... 1/9 . . . A/Z/A/Z MNPRS  
..... 1/9 . . . A/Z MNPRS  
..... 1/9 . . . A/Z MNPRS  
..... 1/9 . . . A/Z MNPRS

**NE72FH**  
FH FLIP

..... 1/9 . . . A/Z/A/Z MNPRS  
..... 0/90/9 MNPRS  
..... 1/9 . . . A/Z MNPRS  
..... 1/9 . . . A/Z MNPRS  
..... 1/9 . . . A/Z MNPRS  
..... 1/9 . . . A/Z/A/Z MNPRS  
..... 1/9 . . . A/Z MNPRS  
..... 1/9 . . . A/Z MNPRS  
..... 1/9 . . . A/Z MNPRS

**NE73TE**  
TE KEY

..... M-N-P-R-S

**NE73MH**  
MH KEY

..... M-N-P-R-S

**NE73FH**  
FH FLIP

..... M-N-P-R-S

VALEO

VALEO

VALEO

FOR:  
PER:

# NISSAN

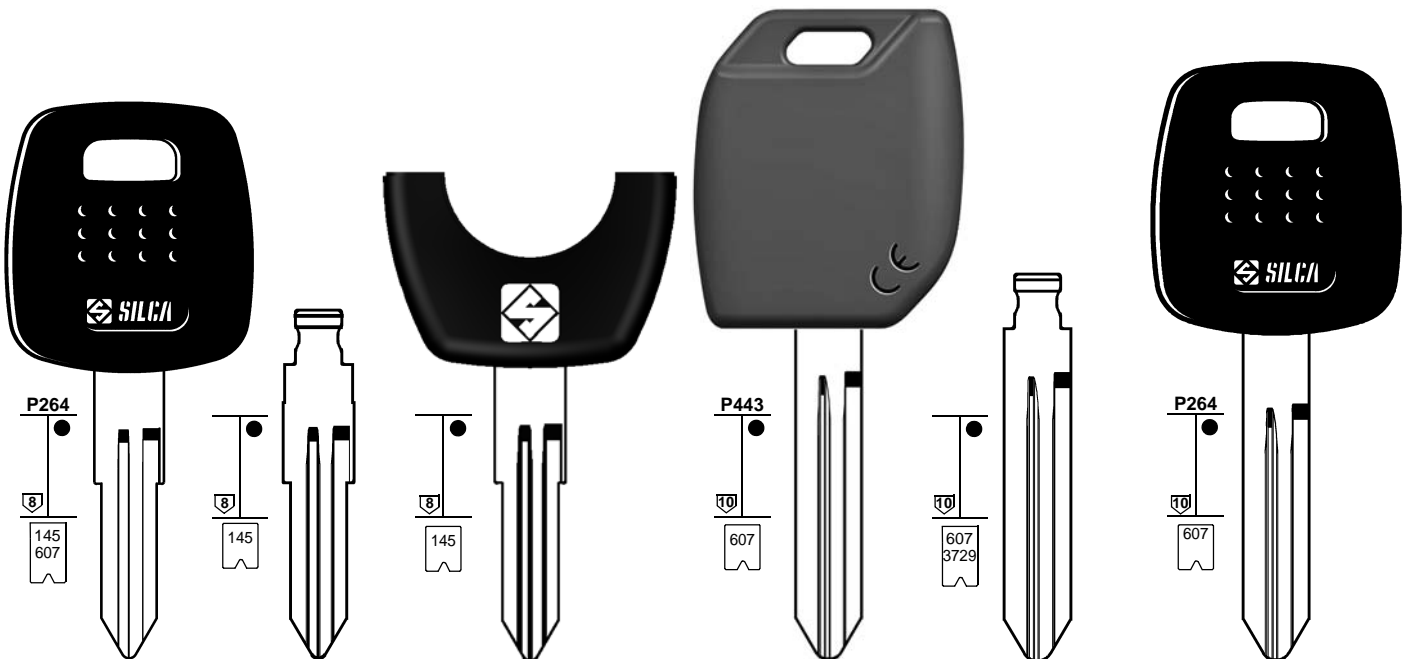

**NSN11T2**  
TE KEY

X . . . . 1-8000  
X . . . . 1-22185  
X . . . . 30001-37850  
X . . . . 8001-9000

**NSN11FH**  
FH FLIP

X . . . . 1-8000  
X . . . . 8001-9000

**NSN11AT25**  
FH FLIP

X . . . . 1-8000  
X . . . . 8001-9000

**NSN14MH**  
MH KEY

..... 1-22185  
..... 30001-37850

**NSN14FH**  
FH FLIP

..... 1-22185

**NSN14TE**  
TE KEY

..... 1-22185  
..... 30001-37850



FOR:  
PER:

# NISSAN

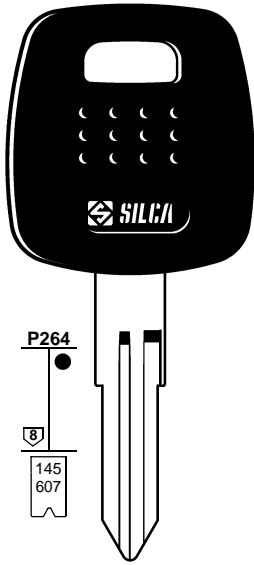

**NSN11T25**  
X . . . . 1-8000  
X . . . . 8001-9000

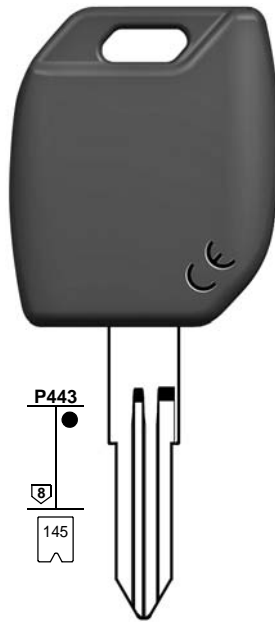

**NSN11MH**  
X . . . . 1-8000  
X . . . . 8001-9000

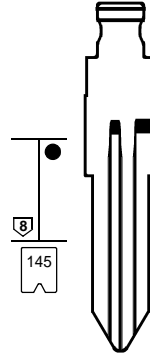

**NSN11FH**  
X . . . . 1-8000  
X . . . . 8001-9000

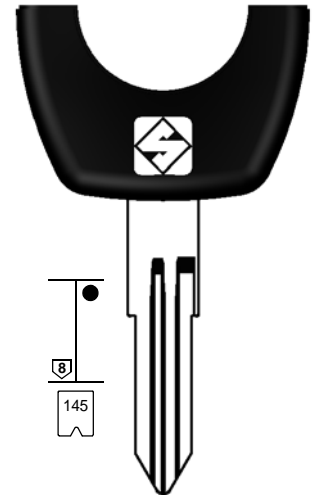

**NSN11AT25**  
X . . . . 1-8000  
X . . . . 8001-9000

**NSN11TE**  
X . . . . 1-8000  
X . . . . 8001-9000

**NSN11T13**  
X . . . . 1-8000  
X . . . . 8001-9000

**NSN11AT13**  
X . . . . 1-8000  
X . . . . 8001-9000

FOR:  
PER:

# NISSAN

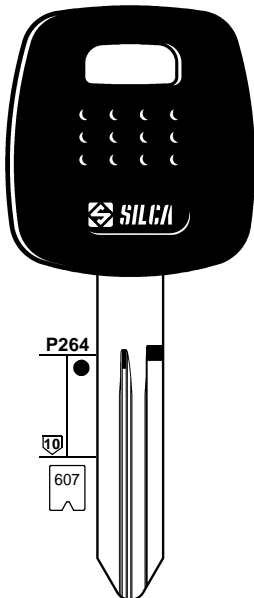

**NSN14T13**  
..... 1-22185

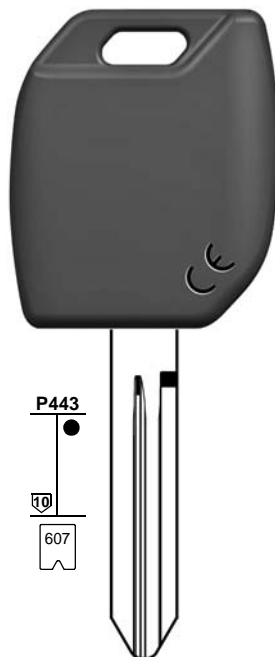

**NSN14MH**  
..... 1-22185  
..... 30001-37850

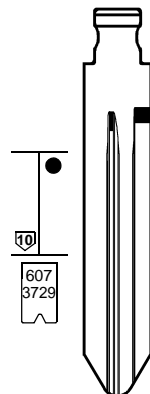

**NSN14FH**  
..... 1-22185

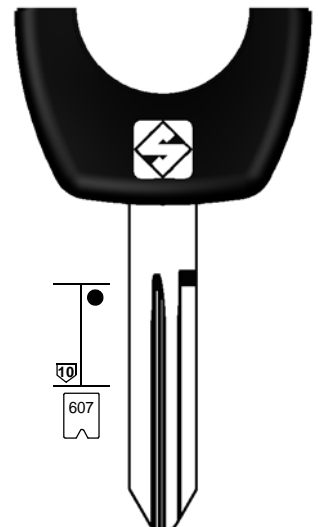

**NSN14AT13**  
..... 1-22185

**NSN14TE**  
..... 1-22185  
..... 30001-37850

**NSN14AT25**  
..... 1-22185

1	2	2a	3	3a	3b	e1+e2		6	42+71	72	43+44a	12	15
						<b>GTI COMPATIBLE</b>		<b>IGNITION</b> 					
<b>CAR MAKE MODEL</b>	FROM	TO	SILCA REF.	SILCA REF.	SILCA REF.	COPY	GEN.	TRANSP. TYPE	FAST COPY PLUS RW4 PLUS FAST COPY/RW4	FAST COPY PLUS RW4 PLUS	FAST COPY RW4	STP	
For more info on the uses of car keys, refer to the Silca Electronic Keys Catalogue:													
<b>NISSAN</b>													
MAXIMA	2000	2003	NSN11T25	NSN11TE	NSN11FH			PH / CR	41	Y	Y		
MICRA	1996	1998	NSN11T2		NSN11FH			PH	33	Y	Y	N-N	
MICRA	1998	2000	NSN11T25	NSN11TE	NSN11FH			PH / CR	41	Y	Y		
MICRA	1998	2000	NSN11AT25					PH / CR	41	Y	Y		
MICRA	2000	2003	NSN11T13					TEX / CR	60				
MICRA	2000	2003	NSN11AT13					TEX / CR	60				
MICRA	2000	2003	NSN11MH	NSN11TE	NSN11FH	Y	Y	TEX / CR	60	Y		P-BOX	
MICRA	2003		SMARTKEY					TEX / CR	XX				
MICRA	2003							PH / CR2	46				
MICRA	2003		NSN14MH	NSN14TE	NSN14FH	Y		PH / CR2	46	Y		P-BOX	
MICRA MARCH [J]	1996	1998	NSN11T2		NSN11FH			PH	33	Y	Y	N-N	
MICRA MARCH [J]	1998	2000	NSN11T25	NSN11TE	NSN11FH			PH / CR	41	Y	Y		
MICRA MARCH [J]	1998	2000	NSN11AT25					PH / CR	41	Y	Y		
MICRA MARCH [J]	2000	2003	NSN11AT13					TEX / CR	60				
MICRA MARCH [J]	2000	2003	NSN11T13					TEX / CR	60				
MICRA MARCH [J]	2000	2003	NSN11MH	NSN11TE	NSN11FH	Y	Y	TEX / CR	60	Y		P-BOX	
MICRA VAN	1998	2000	NSN11T25	NSN11TE	NSN11FH			PH / CR	41	Y	Y		
MICRA VAN	1998	2000	NSN11AT25					PH / CR	41	Y	Y		
MICRA VAN	2000	2003	NSN11T13					TEX / CR	60				
MICRA VAN	2000	2003	NSN11AT13					TEX / CR	60				
MICRA VAN	2000	2003	NSN11MH	NSN11TE	NSN11FH	Y	Y	TEX / CR	60	Y		P-BOX	
MURANO	2003	2007	NSN14AT13					TEX / CR	XX				
MURANO	2003	2007	NSN14T13					TEX / CR	XX				
MURANO	2003	2007	NSN14MH	NSN14TE	NSN14FH	Y	Y	TEX / CR	XX	Y		P-BOX	
MURANO	2009		SMARTKEY					PH / CR2	46				
NAVARA	2000	2003	NSN14T25	NSN14TE	NSN14FH			PH / CR	41	Y	Y		
NAVARA	2000	2003	NSN14AT25					PH / CR	41	Y	Y		
NAVARA	2003	2005	NSN14AT13					TEX / CR	60				
NAVARA	2003	2005	NSN14T13					TEX / CR	60				
NAVARA	2003	2005	NSN14T13					TEX / CR	XX				
NAVARA	2003	2005	NSN14AT13					TEX / CR	XX				
NAVARA	2003	2005	NSN14MH	NSN14TE	NSN14FH	Y	Y	TEX / CR	60	Y		P-BOX	
NAVARA	2003	2005	NSN14MH	NSN14TE	NSN14FH	Y	Y	TEX / CR	XX	Y		P-BOX	
NAVARA	2005							PH / CR2	46				
NAVARA	2005		NSN14MH	NSN14TE	NSN14FH	Y		PH / CR2	46	Y		P-BOX	
NOTE	2006							PH / CR2	46				
NOTE	2006		SMARTKEY					TEX / CR	XX				
NOTE	2006		NSN14MH	NSN14TE	NSN14FH	Y		PH / CR2	46	Y		P-BOX	
NP300	2010							PH / CR2	46				
NP300	2010		NSN14MH	NSN14TE	NSN14FH	Y		PH / CR2	46	Y		P-BOX	
NV400	2011							PH / CR2	46				

FOR:  
PER:

# NISSAN

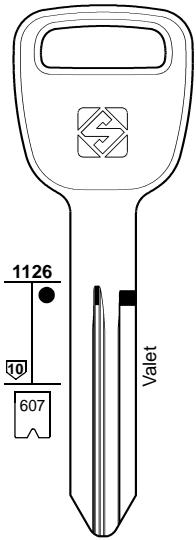

**NSN15**

..... 1-22185

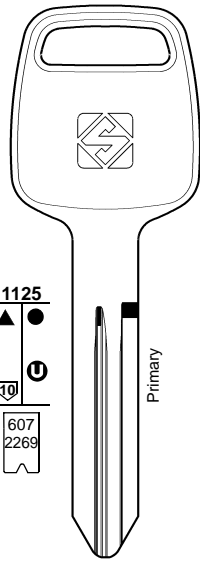

**NSN14**

..... 1-22185

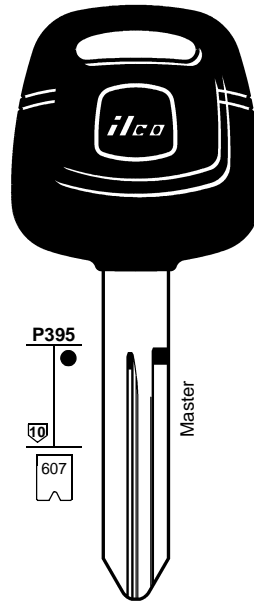

**NI02T**

..... 1-22185

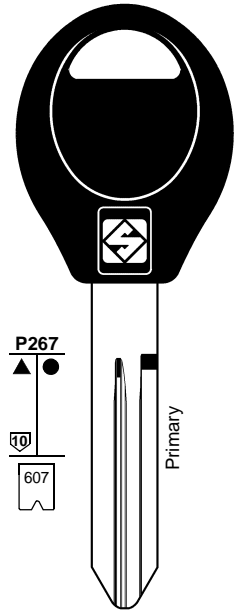

**NSN14CP**

..... 1-22185

FOR:  
PER:

# NISSAN

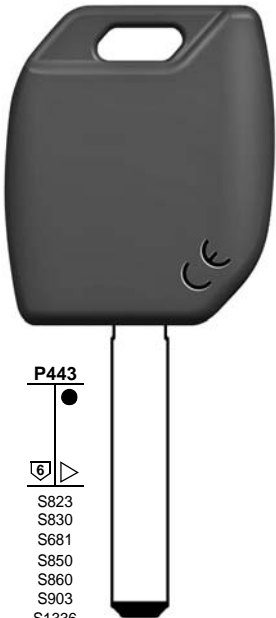

**VA6MH**

..... 1234Q5678H  
..... ABCDEF  
..... 12897-A9999

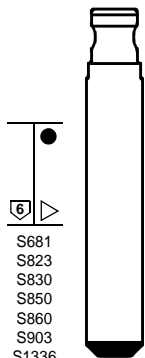

**VA6FH**

..... 12897-A9999  
..... ABCDEF  
..... 1234Q5678H

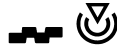
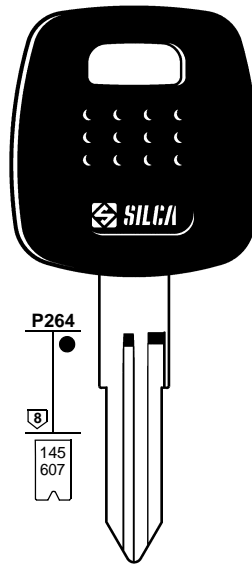

**NSN11T2**

X ..... 1-8000  
..... 1-22185  
..... 30001-37850  
X ..... 8001-9000

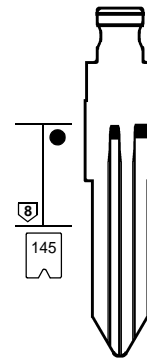

**NSN11T25**

X ..... 1-8000  
X ..... 8001-9000

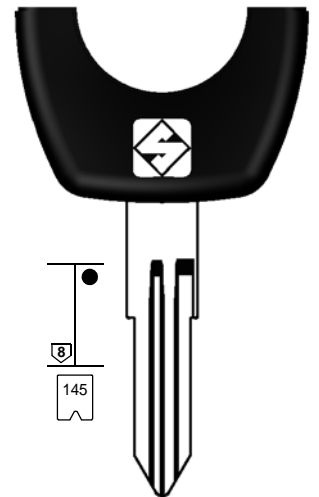

**NSN11FH**

X ..... 1-8000  
X ..... 8001-9000



**NSN11AT25**

X ..... 1-8000  
X ..... 8001-9000



**NSN11TE**

X ..... 1-8000  
X ..... 8001-9000

HUF - VALEO





FOR:  
PER:

# NISSAN

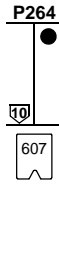

**NSN14T13**  
..... 1-22185

**NSN14T25**  
..... 1-22185

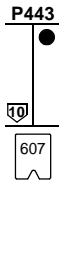

**NSN14MH**  
..... 1-22185  
..... 30001-37850

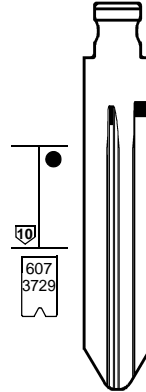

**NSN14FH**  
..... 1-22185

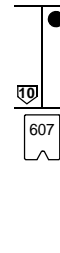

**NSN14AT13**  
..... 1-22185

**NSN14AT25**  
..... 1-22185

**NSN14TE**  
..... 1-22185  
..... 30001-37850

FOR:  
PER:

# NISSAN

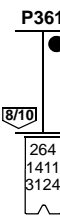

**HU133RT14**  
..... 50001-51308  
U ..... 1-2000  
IP ..... 5001-6308

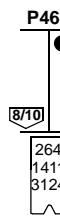

**HU133RTE**  
..... 50001-51308  
U ..... 1-2000  
IP ..... 5001-6308

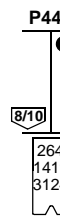

**HU133RMH**  
..... 50001-51308  
U ..... 1-2000  
IP ..... 5001-6308

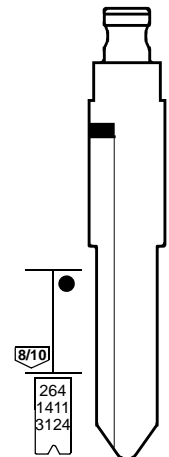

**HU133RFH**  
..... 50001-51308  
U ..... 1-2000  
IP ..... 5001-6308

HUF

HUF



FOR:  
PER:

# NISSAN

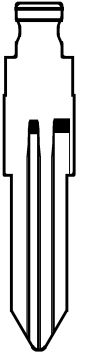
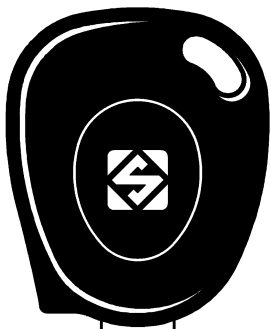

P265

P461

P443

P264

P264

P264

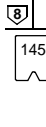
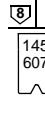
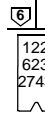
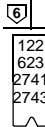
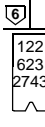
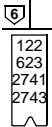

**NE73T32**

..... M-N-P-R-S



**NE72ATE**

..... 1/9 . . A/Z/AZ MNPRS  
..... 0/90/9 MNPRS  
..... 1/9 . . A/Z MNPRS  
..... 1/9 . . A/Z MNPRS  
..... 1/9 . . A/Z MNPRS  
..... 1/9 . . A/Z MNPRS  
..... 1/9 . . A/Z MNPRS  
..... 1/9 . . A/Z MNPRS



**NE72MH**

..... M-N-P-R-S  
..... 0/90/9 MNPRS  
..... 1/9 . . A/Z MNPRS  
..... 1/9 . . A/Z MNPRS  
..... 1/9 . . A/Z/AZ MNPRS  
..... 1/9 . . A/Z MNPRS  
..... 1/9 . . A/Z MNPRS  
..... 1/9 . . A/Z MNPRS  
..... 1/9 . . A/Z MNPRS



**NE72FH**

..... 1/9 . . A/Z/AZ MNPRS  
..... 0/90/9 MNPRS  
..... 1/9 . . A/Z MNPRS  
..... 1/9 . . A/Z MNPRS  
..... 1/9 . . A/Z MNPRS  
..... 1/9 . . A/Z MNPRS  
..... 1/9 . . A/Z MNPRS  
..... 1/9 . . A/Z MNPRS



**NSN11T2**

X . . . . 1-8000  
..... 1-22185  
..... 30001-37850  
X . . . . 8001-9000



**NSN11FH**

X . . . . 1-8000  
X . . . . 8001-9000

VALEO

VALEO

VALEO

FOR:  
PER:

# NISSAN

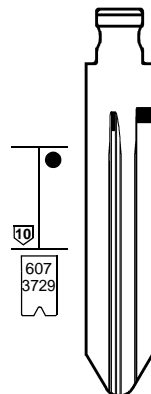

P264

P443

P264

P264



**NSN14T13**

..... 1-22185



**NSN14T25**

..... 1-22185



**NSN14MH**

..... 1-22185  
..... 30001-37850



**NSN14FH**

..... 1-22185



**NSN14AT13**

..... 1-22185



**NSN14TE**

..... 1-22185  
..... 30001-37850



**NSN14T5**

..... 1-22185



**NSN14AT25**

..... 1-22185



FOR:  
PER:

# NISSAN

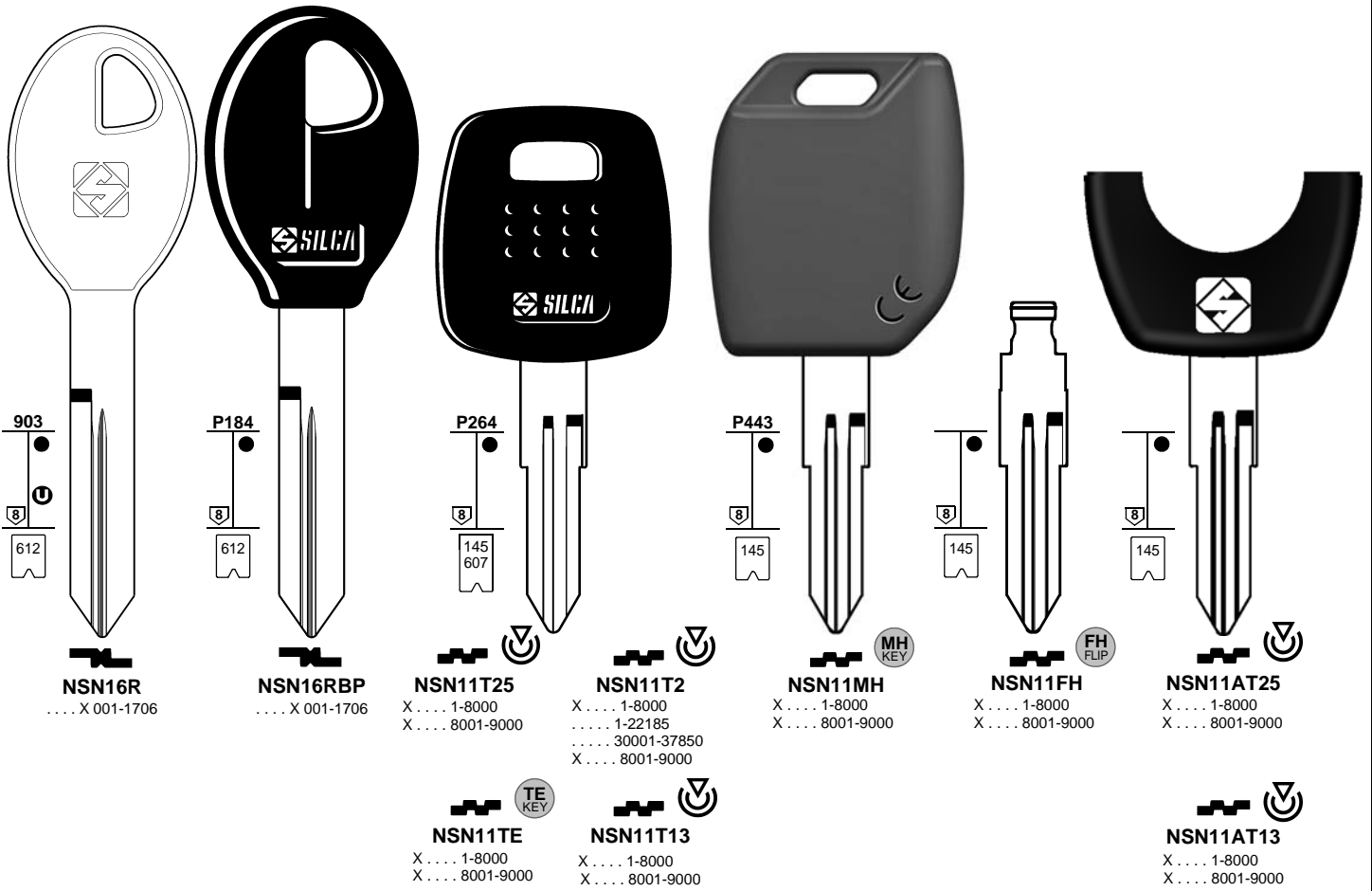

FOR:  
PER:

# NISSAN

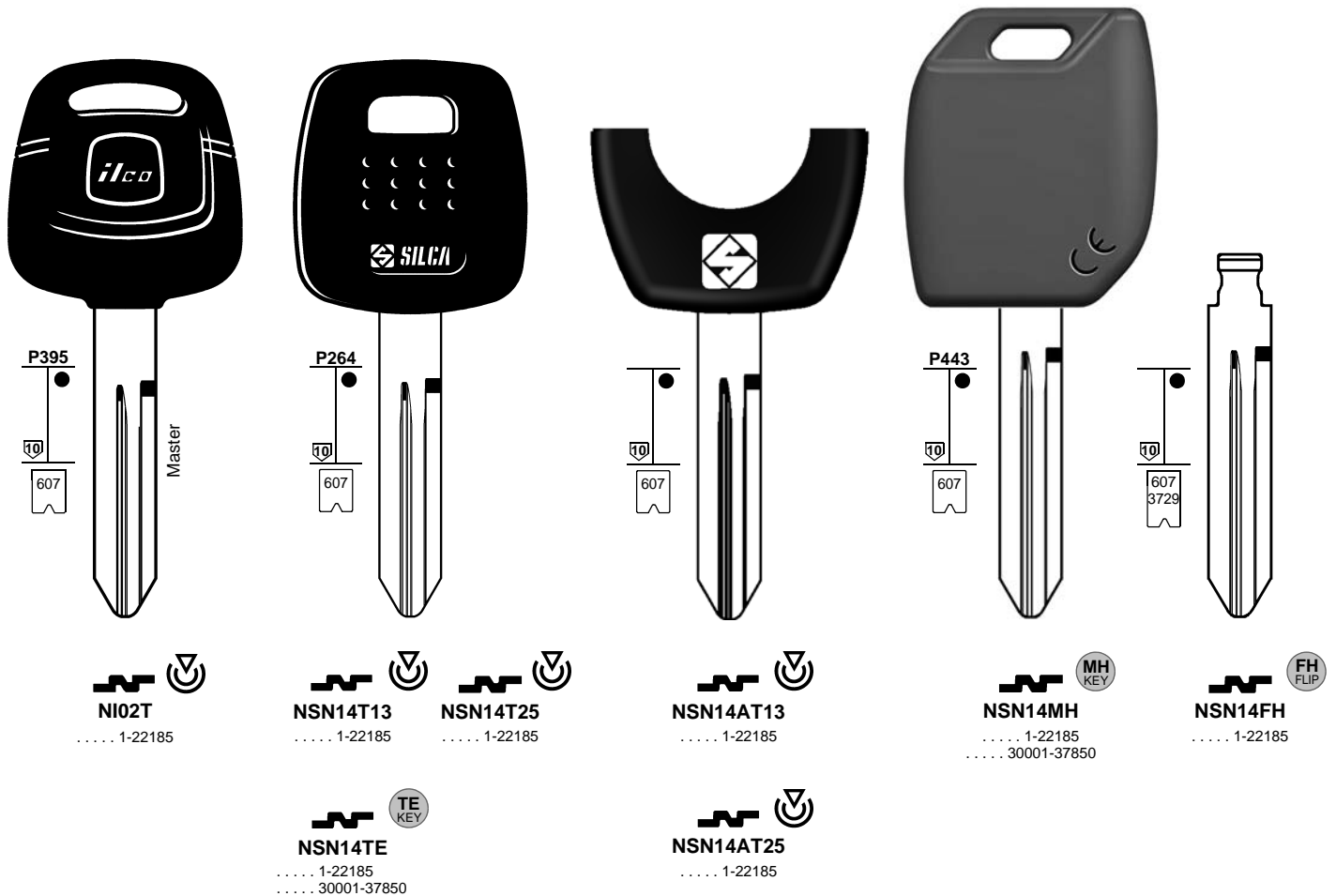



FOR:  
PER:

# NISSAN USA

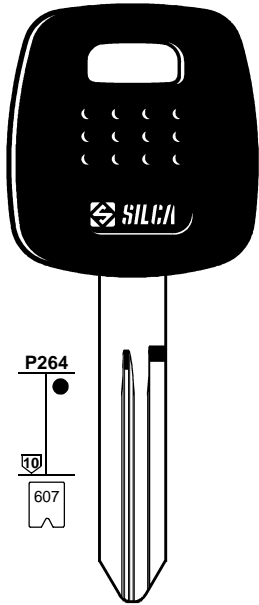

P264  
607

   
**NSN14T14**  
..... 1-22185

   
**NSN14TE**  
..... 1-22185  
..... 30001-37850

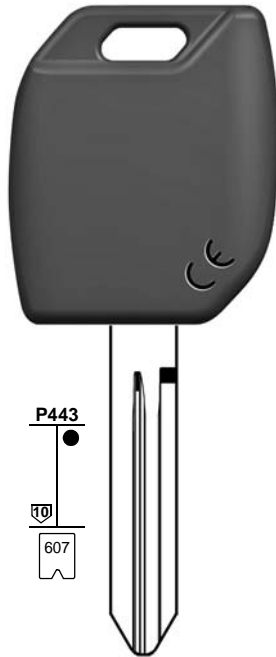

P443  
607

   
**NSN14MH**  
..... 1-22185  
..... 30001-37850

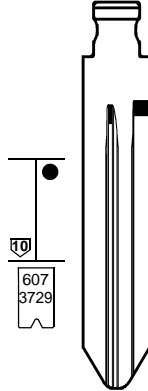

607  
3729

   
**NSN14FH**  
..... 1-22185

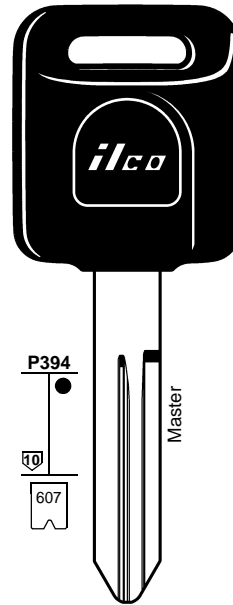

P394  
607  
Master

   
**NI01T**  
..... 1-22185

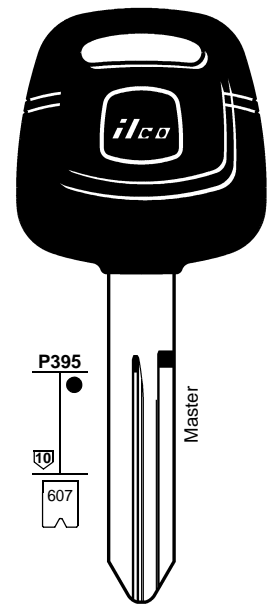

P395  
607  
Master



   
**NI02T**  
..... 1-22185

FOR:  
PER:

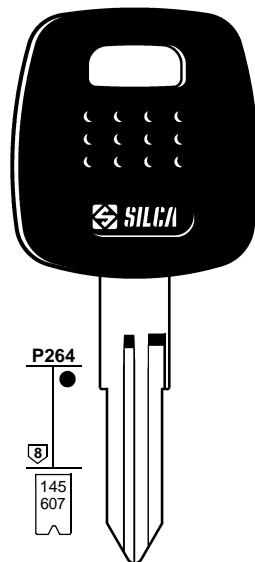
# NISSAN USA



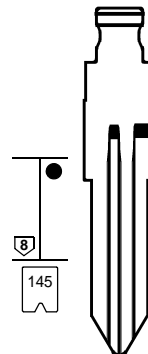

P264  
145  
607

   
**NSN11T2**  
X ..... 1-8000  
..... 1-22185  
..... 30001-37850  
X ..... 8001-9000



145

   
**NSN11FH**  
X ..... 1-8000  
X ..... 8001-9000

VALEO

1	2	2a	3	3a	3b	e1+e2		6	42+71	72	43+44a	12	15
						<b>GTI COMPATIBLE</b>		<b>IGNITION</b> 					
<b>CAR MAKE MODEL</b>	<b>FROM</b>	<b>TO</b>	<b>SILCA REF.</b>	<b>SILCA REF.</b>	<b>SILCA REF.</b>	<b>COPY</b>	<b>GEN.</b>	<b>TRANSP. TYPE</b>	<b>FAST COPY PLUS RW4 PLUS FAST COPY/RW4</b>	<b>FAST COPY PLUS RW4 PLUS</b>	<b>FAST COPY RW4</b>	<b>STP</b>	
For more info on the uses of car keys, refer to the Silca Electronic Keys Catalogue:													
<b>NISSAN USA</b>													
<b>350Z</b>	2003	2009	<b>NSN14T14</b>					PH / CR2	46				
<b>350Z</b>	2003	2009	<b>NSN14MH</b>	<b>NSN14TE</b>	<b>NSN14FH</b>	Y	Y	PH / CR2	46	Y	P-BOX		
<b>ALTIMA</b>	2000	2004	<b>NI01T</b>					TEX / CR	60				
<b>ALTIMA</b>	2005	2006	<b>NSN14T14</b>					PH / CR2	46				
<b>ALTIMA</b>	2005	2006	<b>NSN14MH</b>	<b>NSN14TE</b>	<b>NSN14FH</b>	Y	Y	PH / CR2	46	Y	P-BOX		
<b>ALTIMA</b>	2007		<b>SMARTKEY</b>					PH / CR2	46				
<b>ARMADA</b>	2004		<b>NSN14T14</b>					PH / CR2	46				
<b>ARMADA</b>	2004		<b>NSN14MH</b>	<b>NSN14TE</b>	<b>NSN14FH</b>	Y	Y	PH / CR2	46	Y	P-BOX		
<b>ARMADA</b>	2008		<b>SMARTKEY</b>					PH / CR2	46				
<b>CUBE</b>	2009		<b>SMARTKEY</b>					PH / CR2	46				
<b>CUBE</b>	2009		<b>NSN14T14</b>					PH / CR2	46				
<b>CUBE</b>	2009		<b>NSN14MH</b>	<b>NSN14TE</b>	<b>NSN14FH</b>	Y	Y	PH / CR2	46	Y	P-BOX		
<b>FRONTIER</b>	2002	2005	<b>NI02T</b>					TEX / CR	60				
<b>FRONTIER</b>	2002	2005	<b>NSN14MH</b>	<b>NSN14TE</b>	<b>NSN14FH</b>	Y	Y	TEX / CR	60	Y	P-BOX		
<b>FRONTIER</b>	2005		<b>NSN14T14</b>					PH / CR2	46				
<b>FRONTIER</b>	2005		<b>NSN14MH</b>	<b>NSN14TE</b>	<b>NSN14FH</b>	Y	Y	PH / CR2	46	Y	P-BOX		
<b>JUKE</b>	2011		<b>SMARTKEY</b>					PH / CR2	46				
<b>JUKE</b>	2011		<b>NSN14T14</b>					PH / CR2	46				
<b>JUKE</b>	2011		<b>NSN14MH</b>	<b>NSN14TE</b>	<b>NSN14FH</b>	Y	Y	PH / CR2	46	Y	P-BOX		
<b>LIVINA</b>	2007		<b>NSN14T14</b>					PH / CR2	46				
<b>LIVINA</b>	2007		<b>SMARTKEY</b>					PH / CR2	46				
<b>LIVINA</b>	2007		<b>NSN14MH</b>	<b>NSN14TE</b>	<b>NSN14FH</b>	Y	Y	PH / CR2	46	Y	P-BOX		
<b>MAXIMA</b>	1995	2000	<b>NSN11T2</b>		<b>NSN11FH</b>			PH	33	Y	Y	N-N	
<b>MAXIMA</b>	2000	2003	<b>NI02T</b>					TEX / CR	60				
<b>MAXIMA</b>	2000	2003	<b>NSN14MH</b>	<b>NSN14TE</b>	<b>NSN14FH</b>	Y	Y	TEX / CR	60	Y	P-BOX		
<b>MAXIMA</b>	2004	2007	<b>NSN14T14</b>					PH / CR2	46				
<b>MAXIMA</b>	2004	2007	<b>NSN14MH</b>	<b>NSN14TE</b>	<b>NSN14FH</b>	Y	Y	PH / CR2	46	Y	P-BOX		
<b>MAXIMA</b>	2009		<b>SMARTKEY</b>					PH / CR2	46				
<b>MURANO</b>	2003	2008	<b>NSN14T14</b>					PH / CR2	46				
<b>MURANO</b>	2003	2008	<b>NSN14MH</b>	<b>NSN14TE</b>	<b>NSN14FH</b>	Y	Y	PH / CR2	46	Y	P-BOX		
<b>MURANO</b>	2005	2008	<b>SMARTKEY</b>					PH / CR2	46				
<b>NV Series</b>	2012		<b>NSN14T14</b>					PH / CR2	46				
<b>NV Series</b>	2012		<b>NSN14MH</b>	<b>NSN14TE</b>	<b>NSN14FH</b>	Y	Y	PH / CR2	46	Y	P-BOX		
<b>PATHFINDER</b>	1999	2004	<b>NI02T</b>					TEX / CR	60				
<b>PATHFINDER</b>	1999	2004	<b>NI01T</b>					TEX / CR	60				
<b>PATHFINDER</b>	2005		<b>NSN14T14</b>					PH / CR2	46				
<b>PATHFINDER</b>	2005		<b>NSN14MH</b>	<b>NSN14TE</b>	<b>NSN14FH</b>	Y	Y	PH / CR2	46	Y	P-BOX		
<b>PATHFINDER</b>	2008		<b>SMARTKEY</b>					PH / CR2	46				
<b>QUEST</b>	2004	2010	<b>NSN14T14</b>					PH / CR2	46				
<b>QUEST</b>	2004	2010	<b>NSN14MH</b>	<b>NSN14TE</b>	<b>NSN14FH</b>	Y	Y	PH / CR2	46	Y	P-BOX		
<b>QUEST</b>	2011		<b>SMARTKEY</b>					PH / CR2	46				
<b>ROGUE</b>	2007		<b>SMARTKEY</b>					PH / CR2	46				
<b>ROGUE</b>	2007		<b>NSN14T14</b>					PH / CR2	46				
<b>ROGUE</b>	2007		<b>NSN14MH</b>	<b>NSN14TE</b>	<b>NSN14FH</b>	Y	Y	PH / CR2	46	Y	P-BOX		
<b>SENTRA</b>	2000	2006	<b>NI02T</b>					TEX / CR	60				
<b>SENTRA</b>	2007		<b>SMARTKEY</b>					PH / CR2	46				



FOR:  
PER:

# NISSAN USA

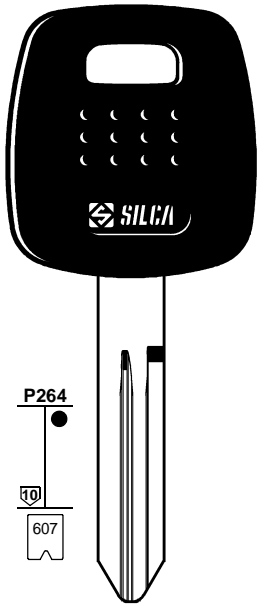

  
**NSN14T14**  
..... 1-22185

  
**NSN14TE**  
..... 1-22185  
..... 30001-37850

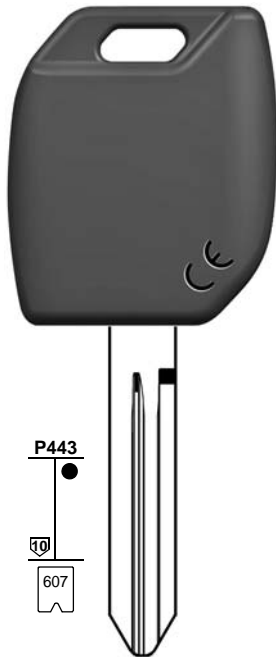

  
**NSN14MH**  
..... 1-22185  
..... 30001-37850

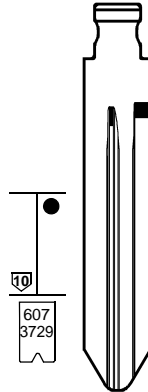

  
**NSN14FH**  
..... 1-22185

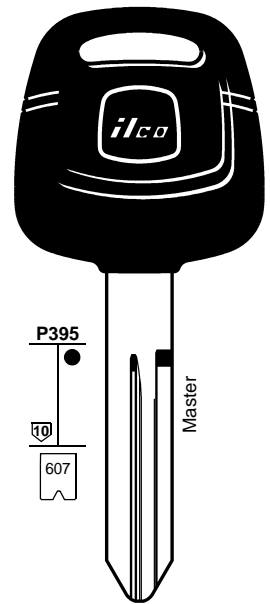

  
**NI02T**  
..... 1-22185

FOR:  
PER:

# OLDSMOBILE

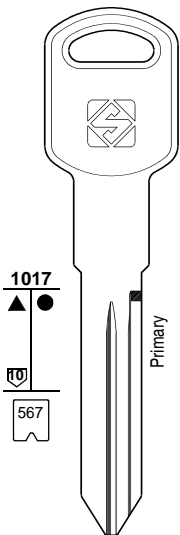

..... AA00-7T51  
..... S000A-S711K

  
**GM39**

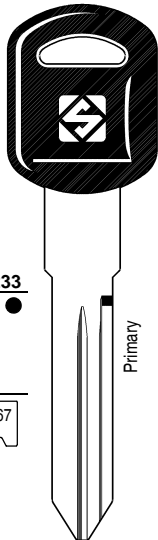

..... AA00-7T51  
..... S000A-S711K

  
**GM39EP**

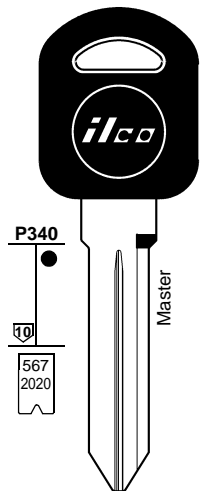

..... 1-1988  
H..... 1-3988  
O..... 5000-6999  
..... S000A-S711K

  
**B97-PT**

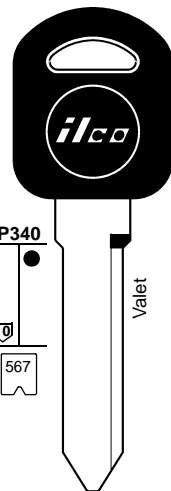

..... 1-1988  
H..... 1-3988  
O..... 5000-6999  
..... S000A-S711K

  
**B98-PT**

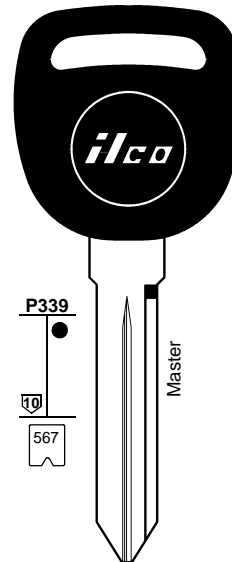

..... 1-1988  
H..... 1-3988  
O..... 5000-6999  
..... S000A-S711K

  
**B99-PT**

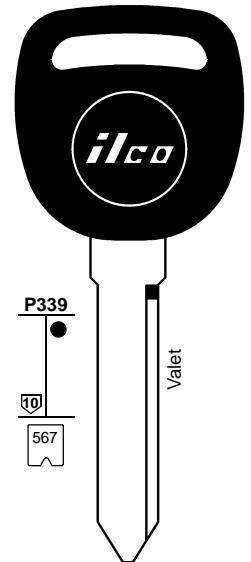

..... 1-1988  
H..... 1-3988  
O..... 5000-6999  
..... S000A-S711K

  
**B100-PT**

**BRIGGS & STRATTON  
GENERAL MOTORS**

**BRIGGS & STRATTON**

**BRIGGS & STRATTON**



FOR:  
PER:

# OPEL-VAUXHALL

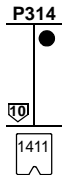

**HU87RT5**

.....  
50001-51308



**HU87RT12**

.....  
50001-51308

HUF - VALEO

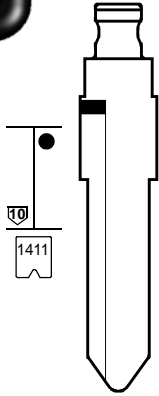

**HU87RFH**

..... 50001-51308

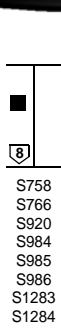
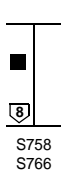
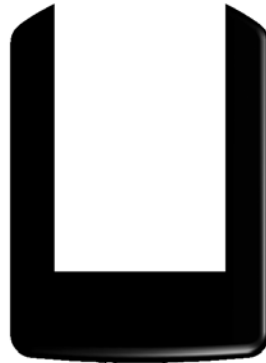

**HU100BT12**

Z .... 1-2000  
Z .... 2001-4000  
Z .... 4001-6000  
..... 0001-3679

HUF - VALEO

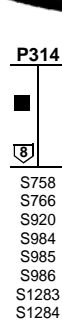

**HU100T12**

Z .... 1-2000  
Z .... 2001-4000  
Z .... 4001-6000  
..... 0001-3679

HUF - VALEO

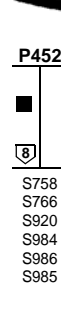
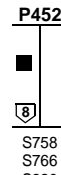

**HU100TE**

Z .... 1-2000  
Z .... 2001-4000  
Z .... 4001-6000

FOR:  
PER:

# OPEL-VAUXHALL

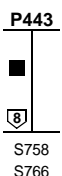

**HU100MH**

Z .... 1-2000  
Z .... 2001-4000  
Z .... 4001-6000

HUF - VALEO

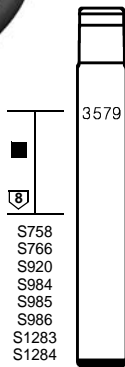

**HU100FH**

Z .... 1-2000  
Z .... 2001-4000  
Z .... 4001-6000  
..... 0001-3679

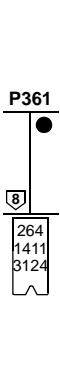
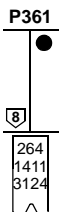

**HU133RT12**

..... 50001-51308



**HU133RT14**

..... 50001-51308  
IP .... 5001-6308  
U .... 1-2000

HUF

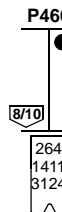

**HU133RTE**

..... 50001-51308  
U .... 1-2000  
IP .... 5001-6308

HUF

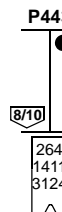

**HU133RMH**

..... 50001-51308  
U .... 1-2000  
IP .... 5001-6308

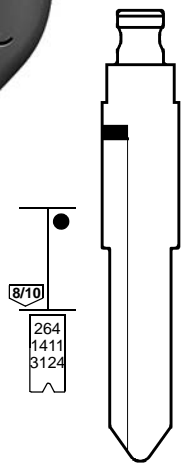

**HU133RFH**

..... 50001-51308  
U .... 1-2000  
IP .... 5001-6308

HUF



FOR:  
PER:

# OPEL-VAUXHALL

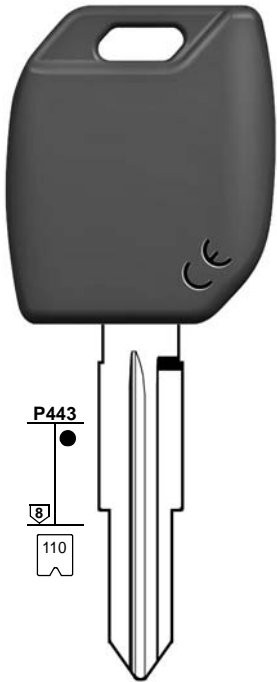

P443  
8  
110

**DWO5MH**  
T . . . . 1-1200

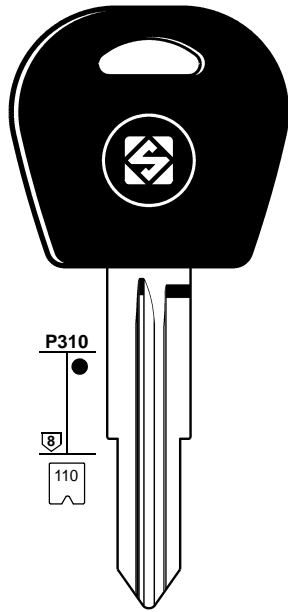

P310  
8  
110

**DWO5TE**  
T . . . . 1-1200

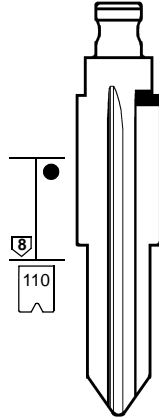

8  
110

**DWO5FH**  
T . . . . 1-1200  
L . . . . 1-1200  
V . . . . 1-1200  
V . . . . 2001-3200

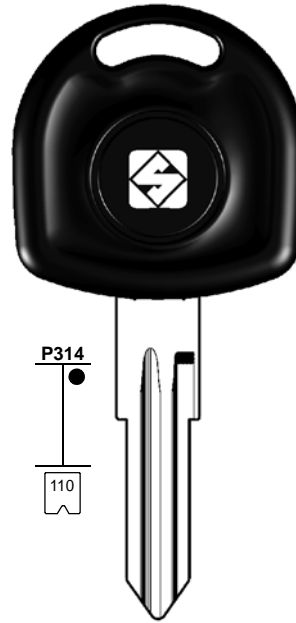

P314  
8  
110

**HU46T2**  
S . . . . 1-5200  
S . . . . 5298-6300

**HU46T9**  
S . . . . 1-5200  
S . . . . 5298-6300

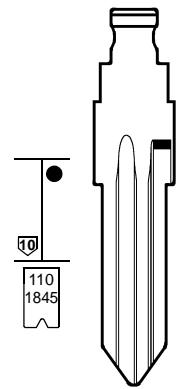

10  
110  
1845

**HU46FH**  
S . . . . 5298-6300  
S . . . . 1-5200

**HU46T12**  
S . . . . 1-5200  
S . . . . 5298-6300

HUF - WITTE

FOR:  
PER:

# OPEL-VAUXHALL

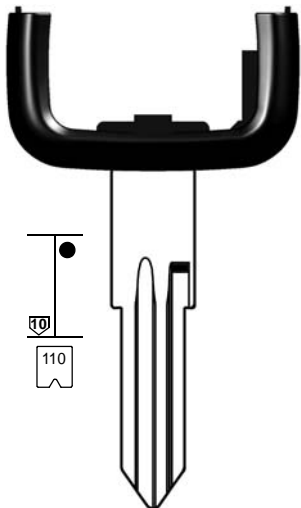

10  
110

**HU46AT9**  
S . . . . 1-5200  
S . . . . 5298-6300

HUF - VALEO

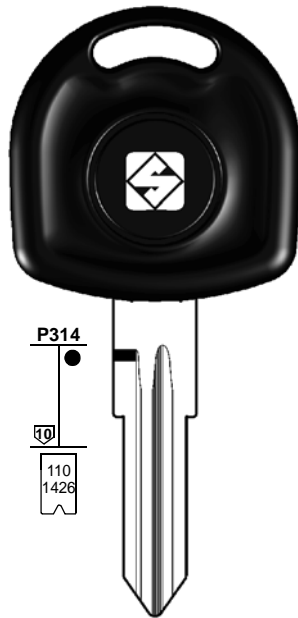

P314  
10  
110  
1426

**HU46AT12**  
S . . . . 1-5200  
S . . . . 5298-6300

VALEO - YMOS

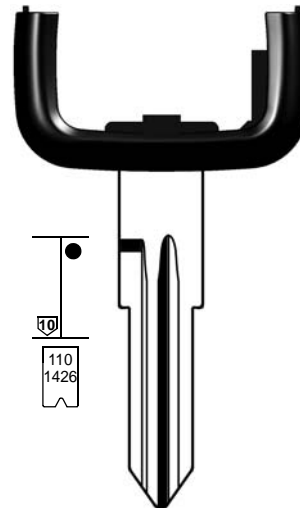

10  
110  
1426

**YM28AT9**  
D . . . . 1-5200  
S . . . . 1-5200  
S . . . . 5298-6300  
S . . . . 1002-3997  
S . . . . 4000-5874

HUF - VALEO

**YM28AT12**  
D . . . . 1-5200  
S . . . . 1-5200  
S . . . . 5298-6300  
S . . . . 1002-3997  
S . . . . 4000-5874

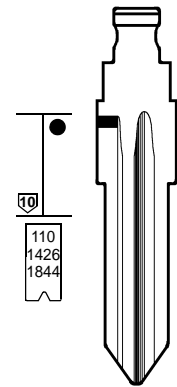

10  
110  
1426  
1844

**YM28FH**  
D . . . . 1-5200  
D . . . . 1002-3997  
D . . . . 4000-5874  
D . . . . 1-5200

HUF - VALEO



FOR:  
PER:

# OPEL-VAUXHALL

**YM27T2**  
Y .....  
WY ..... 1-3000

**HU43T2**  
H ..... 0001-3000  
WH ..... 0001-3000

**HU43FH**  
H ..... 1-3000  
WH ..... 1-3000  
WY ..... 1-3000  
Y ..... 1-3000

**HU46T2**  
S ..... 1-5200  
S ..... 5298-6300

**HU46AT12**  
S ..... 1-5200  
S ..... 5298-6300

**HU46FH**  
S ..... 5298-6300  
S ..... 1-5200

**HU46T12**  
S ..... 1-5200  
S ..... 5298-6300

**YMOS**                      **HUF - YMOS**                      **HUF**                      **HUF - VALEO**                      **WITTE**

FOR:  
PER:

# OPEL-VAUXHALL

**HU100TE**  
Z ..... 1-2000  
Z ..... 2001-4000  
Z ..... 4001-6000

**HU100MH**  
Z ..... 1-2000  
Z ..... 2001-4000  
Z ..... 4001-6000

**HU100FH**  
Z ..... 1-2000  
Z ..... 2001-4000  
Z ..... 4001-6000  
..... 0001-3679

**NE73T5**  
..... M-N-P-R-S

**NE73FH**  
..... M-N-P-R-S

**HUF - VALEO**                      **HUF - VALEO**                      **NEIMAN - VALEO**





FOR:  
PER:

# OPEL-VAUXHALL

**HU46T12**  
S ..... 1-5200  
S ..... 5298-6300

**HU46T2**  
S ..... 1-5200  
S ..... 5298-6300

**HU46T9**  
S ..... 1-5200  
S ..... 5298-6300

**HU46FH**  
S ..... 5298-6300  
S ..... 1-5200

**HU46AT9**  
S ..... 1-5200  
S ..... 5298-6300

**HU46BT12**  
S ..... 1-5200  
S ..... 5298-6300

**HU100BT12**  
Z ..... 1-2000  
Z ..... 2001-4000  
Z ..... 4001-6000  
..... 0001-3679

WITTE                      WITTE                      HUF - VALEO

FOR:  
PER:

# OPEL-VAUXHALL

**HU100T12**  
Z ..... 1-2000  
Z ..... 2001-4000  
Z ..... 4001-6000  
..... 0001-3679

**HU100TE**  
Z ..... 1-2000  
Z ..... 2001-4000  
Z ..... 4001-6000  
..... 0001-3679  
(head code P452)

**HU100MH**  
Z ..... 1-2000  
Z ..... 2001-4000  
Z ..... 4001-6000

**HU100FH**  
Z ..... 1-2000  
Z ..... 2001-4000  
Z ..... 4001-6000  
..... 0001-3679

**YM28AT9**  
D ..... 1-5200  
S ..... 1-5200  
S ..... 5298-6300  
..... 1002-3997  
..... 4000-5874

**YM28T2**  
D ..... 1-5200  
S ..... 1-5200  
S ..... 5298-6300  
..... 1002-3997  
..... 4000-5874

**YM28FH**  
D ..... 1-5200  
..... 1002-3997  
..... 4000-5874  
D ..... 1-5200

HUF - VALEO                      VALEO - YMOS                      HUF - VALEO



FOR:  
PER:

# OPEL-VAUXHALL

**P299**  
264

**P276**  
262

**P452**  
S758  
S766  
S920  
S984  
S985  
S986  
S1283  
S1284

**P443**  
3579  
S758  
S766  
S920  
S984  
S985  
S986

**HU100TE**  
Z . . . . 1-2000  
Z . . . . 2001-4000  
Z . . . . 4001-6000

**HU100MH**  
Z . . . . 1-2000  
Z . . . . 2001-4000  
Z . . . . 4001-6000

**HU100FH**  
Z . . . . 1-2000  
Z . . . . 2001-4000  
Z . . . . 4001-6000  
. . . . 0001-3679

**GM15T5**  
N . . . . 5001-7000

**HON58RT6**  
. . . . 5001-8442

**HON58RFH**  
. . . . 5001-8442  
. . . . 10001-15000

**HU100T12**  
Z . . . . 1-2000  
Z . . . . 2001-4000  
Z . . . . 4001-6000  
. . . . 0001-3679  
(head code P314)

HUF - VALEO

HUF - VALEO

FOR:  
PER:

# OPEL-VAUXHALL

**P265**  
122  
623  
2741  
2743

**P265**  
122  
623

**P443**  
122  
623  
2741  
2743

**HU100BT12**  
Z . . . . 1-2000  
Z . . . . 2001-4000  
Z . . . . 4001-6000  
. . . . 0001-3679

**HU46BT12**  
S . . . . 1-5200  
S . . . . 5298-6300

**NE73T5**  
. . . . . M-N-P-R-S

**NE73T32**  
. . . . . M-N-P-R-S

**NE73TE**  
. . . . . M-N-P-R-S

**NE73MH**  
. . . . . M-N-P-R-S

**NE73FH**  
. . . . . M-N-P-R-S

NEIMAN - VALEO



FOR:  
PER:

# OPEL-VAUXHALL

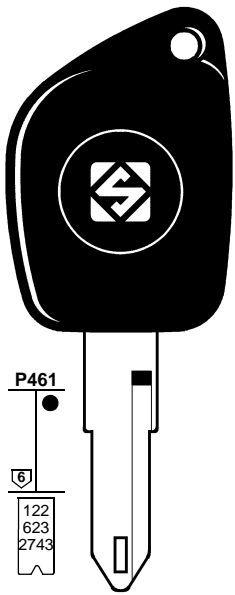

P461  
122  
623  
2743



**NE72ATE**

..... 1/9 . . A/ZA/Z MNPRS  
..... 0/90/9 MNPRS  
..... 1/9 . . A/Z MNPRS  
..... 1/9 . . A/Z MNPRS  
..... 1/9 . . A/Z MNPRS  
..... 1/9 . . A/Z MNPRS  
..... 1/9 . . A/Z MNPRS  
..... 1/9 . . A/Z MNPRS

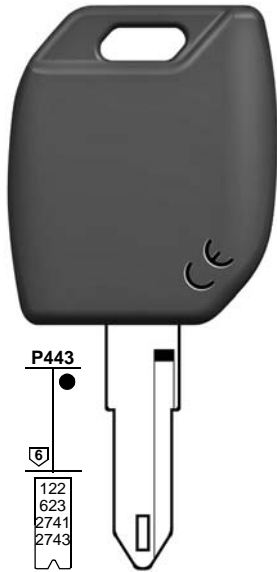

P443  
122  
623  
2741  
2743



**NE72MH**

..... M-N-P-R-S  
..... 0/90/9 MNPRS  
..... 1/9 . . A/Z MNPRS  
..... 1/9 . . A/Z MNPRS  
..... 1/9 . . A/ZA/Z MNPRS  
..... 1/9 . . A/Z MNPRS  
..... 1/9 . . A/Z MNPRS  
..... 1/9 . . A/Z MNPRS  
..... 1/9 . . A/Z MNPRS

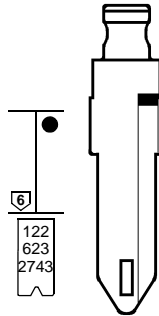

122  
623  
2743



**NE72FH**

..... 1/9 . . A/ZA/Z MNPRS  
..... 0/90/9 MNPRS  
..... 1/9 . . A/Z MNPRS  
..... 1/9 . . A/Z MNPRS  
..... 1/9 . . A/Z MNPRS  
..... 1/9 . . A/Z MNPRS  
..... 1/9 . . A/Z MNPRS  
..... 1/9 . . A/Z MNPRS

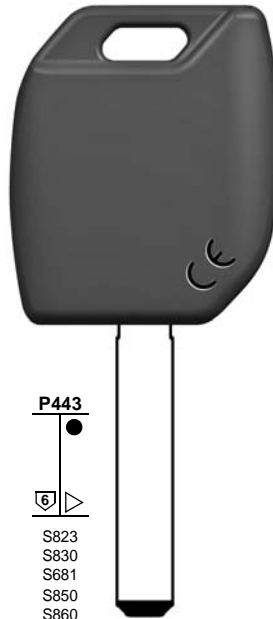

P443  
S823  
S830  
S681  
S850  
S860  
S903  
S1336



**VA6MH**

..... 1234Q5678H  
..... ABCDEF  
..... 12897-A9999

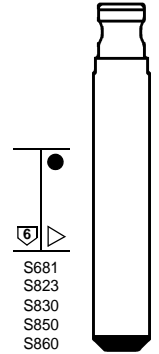

S681  
S823  
S830  
S850  
S860  
S903  
S1336



**VA6FH**

..... 12897-A9999  
..... ABCDEF  
..... 1234Q5678H

VALEO

HUF - VALEO

FOR:  
PER:

# OPEL-VAUXHALL

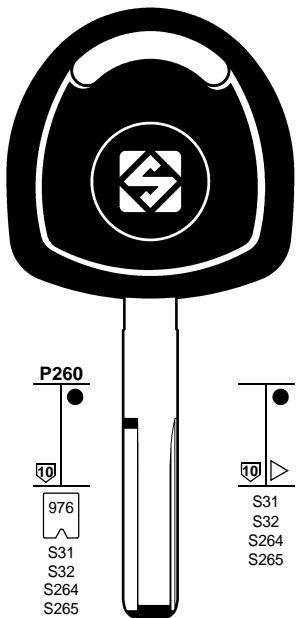

P260  
976  
S31  
S32  
S264  
S265



**HU43T2**

H . . . . . 0001-3000  
WH . . . . . 0001-3000



S31  
S32  
S264  
S265



**HU43FH**

H . . . . . 1-3000  
WH . . . . . 1-3000  
WY . . . . . 1-3000  
Y . . . . . 1-3000

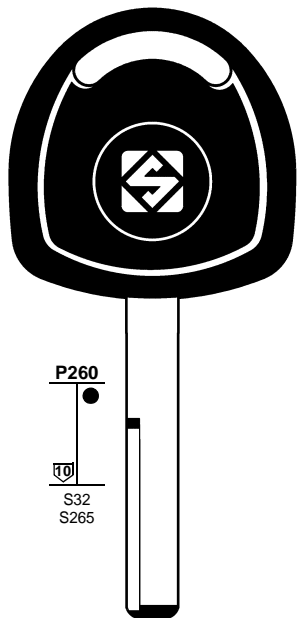

P260  
S32  
S265



**YM27T2**

Y . . . . . 1-3000  
WY . . . . . 1-3000

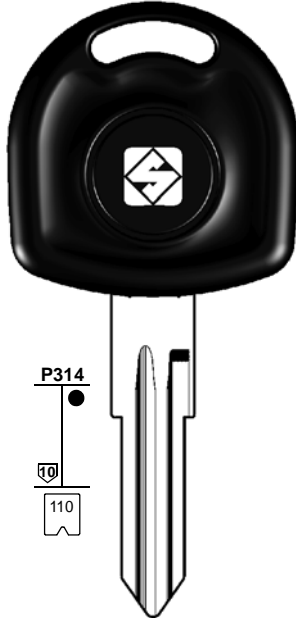

P314  
110



**HU46T9**

S . . . . . 1-5200  
S . . . . . 5298-6300

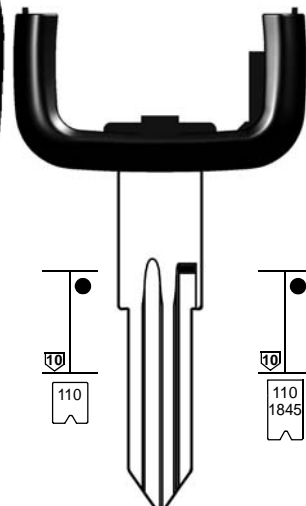

110



**HU46AT9**

S . . . . . 1-5200  
S . . . . . 5298-6300

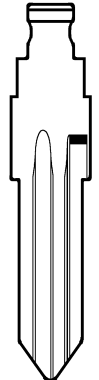

110  
1845



**HU46FH**

S . . . . . 5298-6300  
S . . . . . 1-5200

YMOS

WITTE

HUF - VALEO

WITTE



FOR:  
PER:

# OPEL-VAUXHALL

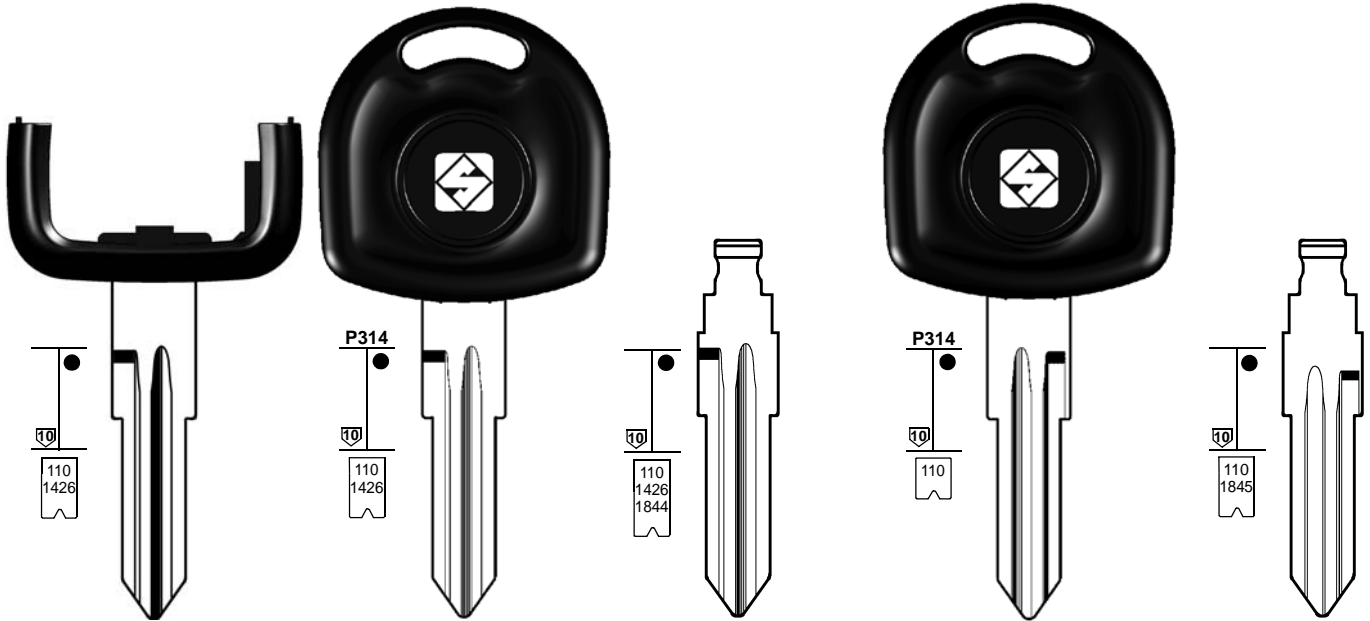

**YM28AT9**

D .... 1-5200  
S .... 1-5200  
S .... 5298-6300  
.... 1002-3997  
.... 4000-5874

HUF - VALEO



**YM28T2**

D .... 1-5200  
S .... 1-5200  
S .... 5298-6300  
.... 1002-3997  
.... 4000-5874

HUF - VALEO



**YM28FH**

D .... 1-5200  
.... 1002-3997  
.... 4000-5874  
D .... 1-5200

HUF - VALEO



**HU46T2**

S .... 1-5200  
S .... 5298-6300

WITTE



**HU46FH**

S .... 5298-6300  
S .... 1-5200

WITTE

FOR:  
PER:

# OPEL-VAUXHALL



**HU43MH**

H .... 1-3000  
WH .... 1-3000  
WY .... 1-3000  
Y .... 1-3000

HUF - VALEO



**HU43TE**

H .... 1-3000  
WH .... 1-3000  
Y .... 1-3000  
WY .... 1-3000

HUF - VALEO



**HU43FH**

H .... 1-3000  
WH .... 1-3000  
WY .... 1-3000  
Y .... 1-3000

HUF - VALEO



**HU100TE**

Z .... 1-2000  
Z .... 2001-4000  
Z .... 4001-6000

HUF - VALEO



**HU100MH**

Z .... 1-2000  
Z .... 2001-4000  
Z .... 4001-6000

HUF - VALEO



**HU100FH**

Z .... 1-2000  
Z .... 2001-4000  
Z .... 4001-6000  
.... 0001-3679





FOR:  
PER:

# OPEL-VAUXHALL



P260



976  
S31  
S32

S264  
S265

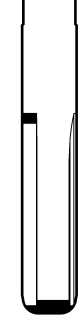

**HU43T2**

H.....0001-3000  
WH.....0001-3000

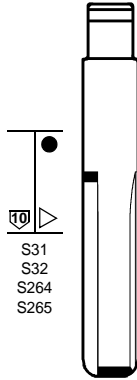

S31  
S32  
S264  
S265



**HU43FH**

H.....1-3000  
WH.....1-3000  
WY.....1-3000  
Y.....1-3000



P314



110

**HU46T12**

S.....1-5200  
S.....5298-6300

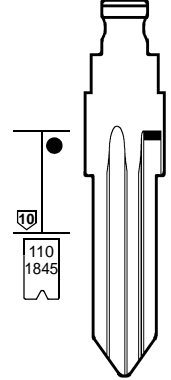

110  
1845



**HU46T9**

S.....1-5200  
S.....5298-6300



**HU46FH**

S.....5298-6300  
S.....1-5200

YMOS

WITTE

WITTE

FOR:  
PER:

# OPEL-VAUXHALL

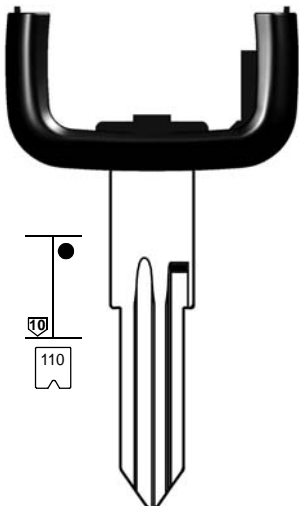

110



**HU46AT9**

S.....1-5200  
S.....5298-6300

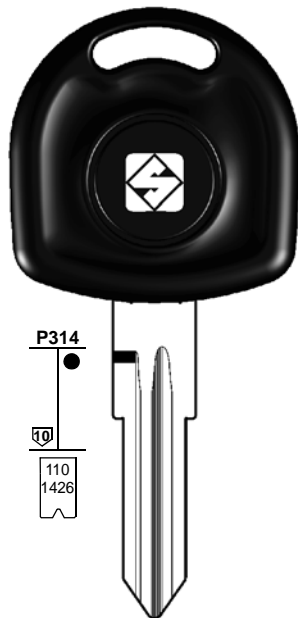

P314



110  
1426



**YM28T2**

D.....1-5200  
S.....1-5200  
S.....5298-6300  
.....1002-3997  
.....4000-5874

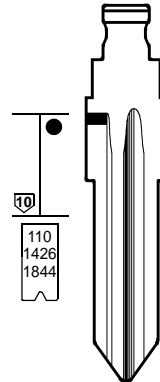

110  
1426  
1844



**YM28FH**

D.....1-5200  
.....1002-3997  
.....4000-5874  
D.....1-5200

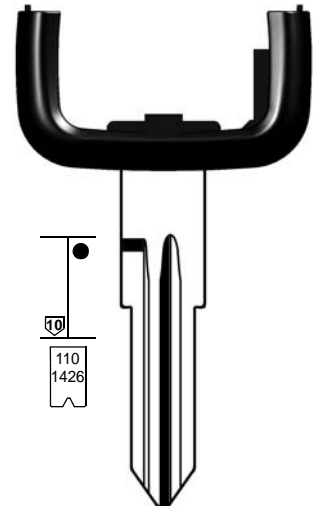

110  
1426



**YM28AT9**

D.....1-5200  
S.....1-5200  
S.....5298-6300  
.....1002-3997  
.....4000-5874



**YM28AT12**

D.....1-5200  
S.....1-5200  
S.....5298-6300  
.....1002-3997  
.....4000-5874

HUF - VALEO

HUF - VALEO

HUF - VALEO

HUF - VALEO



FOR:  
PER:

# OPEL-VAUXHALL

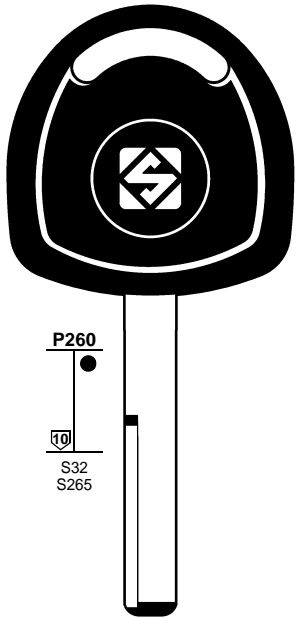



P260  
S32  
S265

   
**YM27T2**  
Y....  
WY....  
1-3000

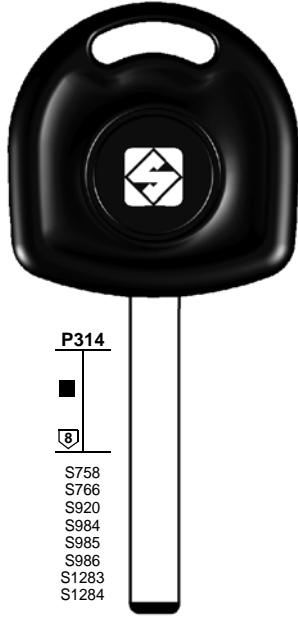
WITTE





P314  
S758  
S766  
S920  
S984  
S985  
S986  
S1283  
S1284

   
**HU100T12**  
Z....1-2000  
Z....2001-4000  
Z....4001-6000  
....0001-3679

HUF - VALEO





3579  
S758  
S766  
S920  
S984  
S985  
S986  
S1283  
S1284

   
**HU100FH**  
Z....1-2000  
Z....2001-4000  
Z....4001-6000  
....0001-3679

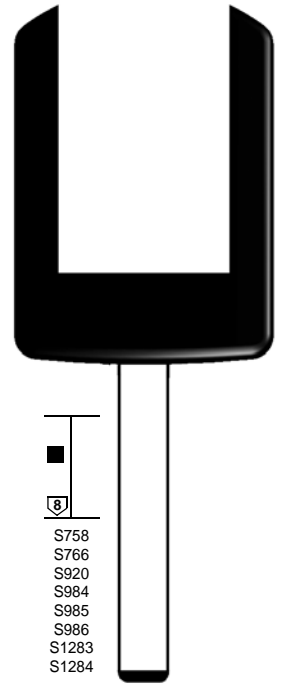
HUF - VALEO



S758  
S766  
S920  
S984  
S985  
S986  
S1283  
S1284

   
**HU100BT12**  
Z....1-2000  
Z....2001-4000  
Z....4001-6000  
....0001-3679



HUF - VALEO

FOR:  
PER:

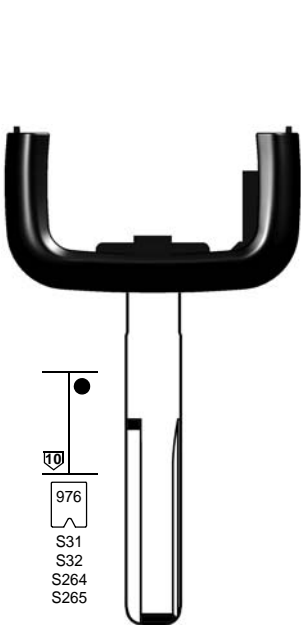
# OPEL-VAUXHALL



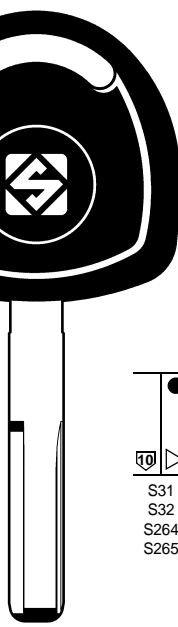

976  
S31  
S32  
S264  
S265

   
**HU43AT9**  
H....1-3000  
WH....1-3000  
WY....1-3000  
Y....1-3000





P260  
976  
S31  
S32  
S264  
S265

   
**HU43T2**  
H....1-3000  
WH....1-3000  
WY....1-3000  
Y....1-3000

WITTE



S31  
S32  
S264  
S265

   
**HU43FH**  
H....1-3000  
WH....1-3000  
WY....1-3000  
Y....1-3000

   
**HU46T12**  
S....1-5200  
S....5298-6300

WITTE

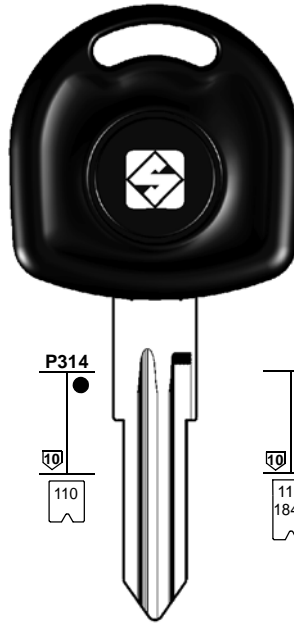

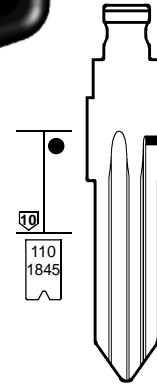

P314  
110

   
**HU46T12**  
S....1-5200  
S....5298-6300



110  
1845

   
**HU46FH**  
S....5298-6300  
S....1-5200

WITTE

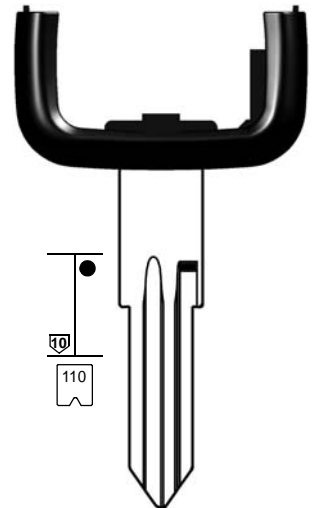

110







   
**HU46AT12**  
S....1-5200  
S....5298-6300

HUF - VALEO

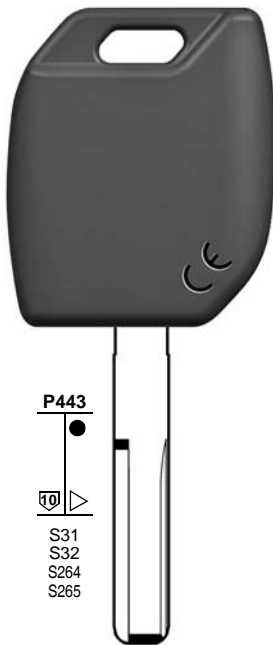
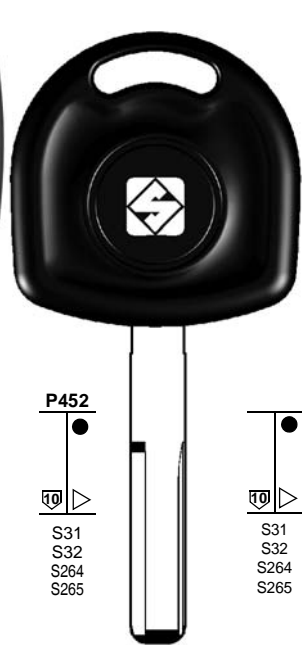
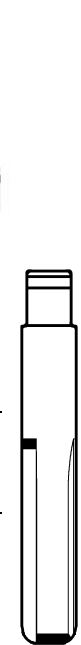
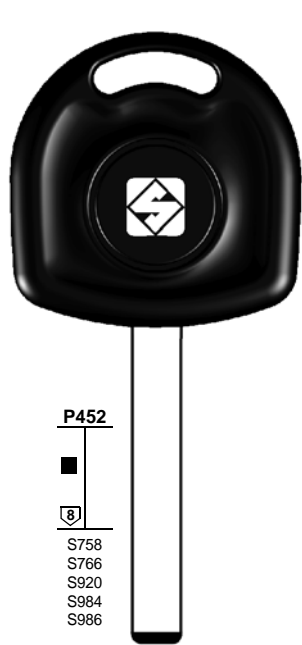
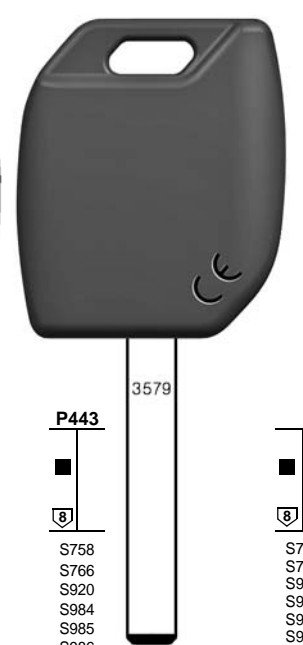
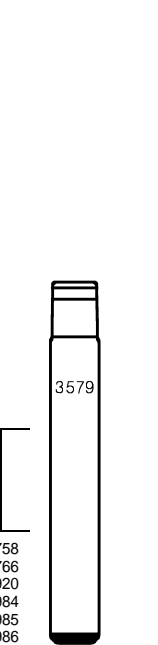

FOR:  
PER:

# OPEL-VAUXHALL







 <p><b>P443</b></p>  <p><b>P452</b></p> 	 <p><b>P452</b></p>  <p><b>P443</b></p> 				
<p>S31 S32 S264 S265</p>	<p>S31 S32 S264 S265</p>	<p>S31 S32 S264 S265</p>	<p>S758 S766 S920 S984 S986</p>	<p>S758 S766 S920 S984 S985 S986</p>	<p>S758 S766 S920 S984 S985 S986 S1283 S1284</p>
 <b>HU43MH</b> H ..... 1-3000 WH ..... 1-3000 WY ..... 1-3000 Y ..... 1-3000	 <b>HU43TE</b> H ..... 1-3000 WH ..... 1-3000 Y ..... 1-3000 WY ..... 1-3000	 <b>HU43FH</b> H ..... 1-3000 WH ..... 1-3000 WY ..... 1-3000 Y ..... 1-3000	 <b>HU100TE</b> Z ..... 1-2000 Z ..... 2001-4000 Z ..... 4001-6000	 <b>HU100MH</b> Z ..... 1-2000 Z ..... 2001-4000 Z ..... 4001-6000	 <b>HU100FH</b> Z ..... 1-2000 Z ..... 2001-4000 Z ..... 4001-6000 ..... 0001-3679

HUF - VALEO

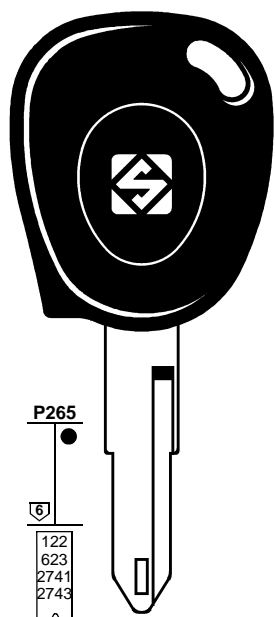
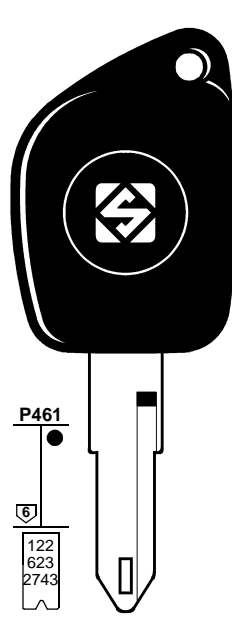
HUF - VALEO

FOR:  
PER:

# OPEL-VAUXHALL

 <p><b>P265</b></p>  <p><b>P461</b></p>  <p><b>P443</b></p> 			
<p>122 623 2741 2743</p>	<p>122 623 2743</p>	<p>122 623 2741 2743</p>	<p>122 623 2741 2743</p>
 <b>NE73T32</b> ..... M-N-P-R-S	 <b>NE72ATE</b> ..... 1/9 . . . A/Z/AZ MNPRS ..... 0/90/9 MNPRS ..... 1/9 . . . A/Z MNPRS ..... 1/9 . . . A/Z MNPRS ..... 1/9 . . . A/Z MNPRS ..... 1/9 . . . A/Z MNPRS ..... 1/9 . . . A/Z MNPRS ..... 1/9 . . . A/Z MNPRS ..... 1/9 . . . A/Z MNPRS	 <b>NE72MH</b> ..... M-N-P-R-S ..... 0/90/9 MNPRS ..... 1/9 . . . A/Z MNPRS ..... 1/9 . . . A/Z MNPRS ..... 1/9 . . . A/Z MNPRS ..... 1/9 . . . A/Z/AZ MNPRS ..... 1/9 . . . A/Z MNPRS ..... 1/9 . . . A/Z MNPRS ..... 1/9 . . . A/Z MNPRS ..... 1/9 . . . A/Z MNPRS	 <b>NE72FH</b> ..... 1/9 . . . A/Z/AZ MNPRS ..... 0/90/9 MNPRS ..... 1/9 . . . A/Z MNPRS ..... 1/9 . . . A/Z MNPRS ..... 1/9 . . . A/Z MNPRS ..... 1/9 . . . A/Z/AZ MNPRS ..... 1/9 . . . A/Z MNPRS ..... 1/9 . . . A/Z MNPRS ..... 1/9 . . . A/Z MNPRS

VALEO

VALEO



FOR:  
PER:

# OPEL-VAUXHALL

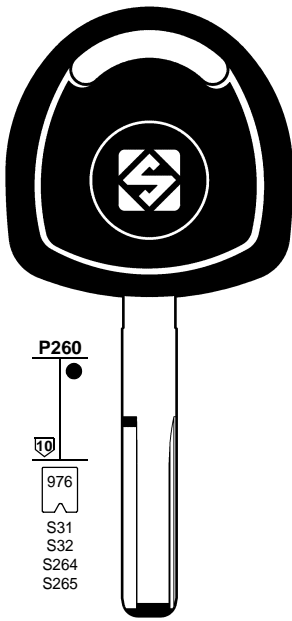

P260  
976  
S31  
S32  
S264  
S265

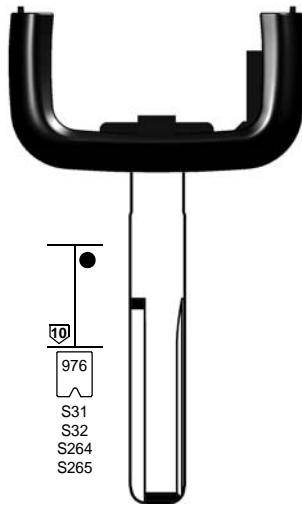

976  
S31  
S32  
S264  
S265

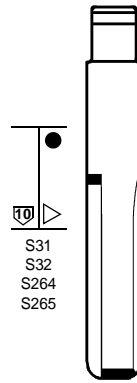

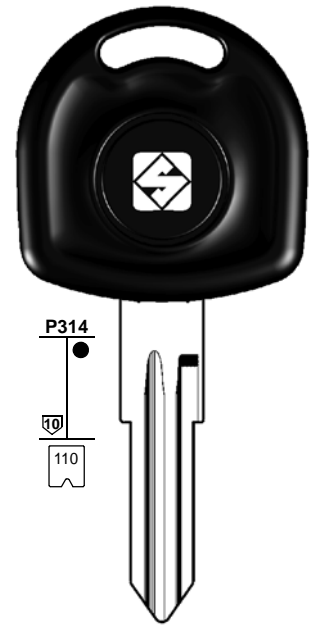

976  
S31  
S32  
S264  
S265



P314  
110

  
**HU43T2**  
H.....1-3000  
WH.....1-3000  
WY.....1-3000  
Y.....1-3000

  
**HU43T9**  
H.....1-3000  
WH.....1-3000  
WY.....1-3000  
Y.....1-3000

  
**HU43AT9**  
H.....1-3000  
WH.....1-3000  
WY.....1-3000  
Y.....1-3000

 **FH FLIP**  
**HU43FH**  
H.....1-3000  
WH.....1-3000  
WY.....1-3000  
Y.....1-3000

  
**HU46T12**  
S.....1-5200  
S.....5298-6300

WITTE

WITTE

FOR:  
PER:

# OPEL-VAUXHALL

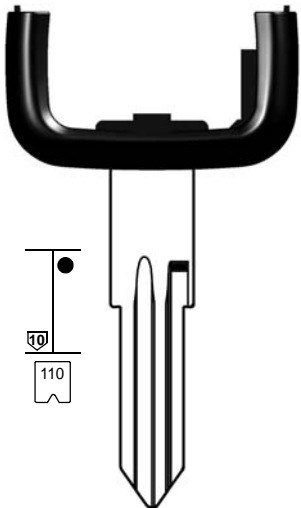

110  
1845

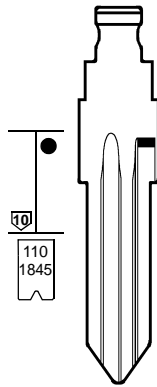

110  
1845

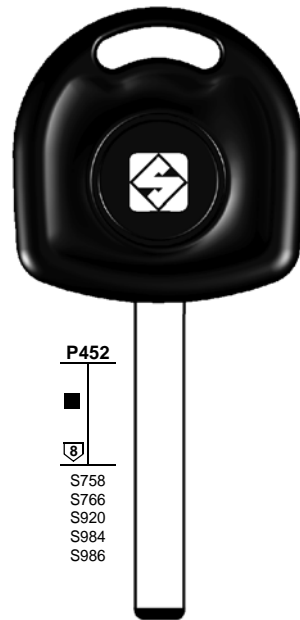

P452  
8  
S758  
S766  
S920  
S984  
S986

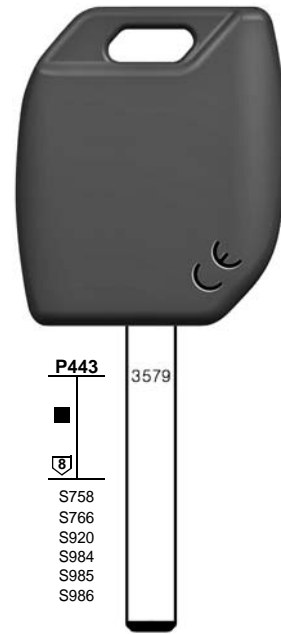

P443  
8  
S758  
S766  
S920  
S984  
S985  
S986





3579  
8  
S758  
S766  
S920  
S984  
S985  
S986  
S1283  
S1284

  
**HU46AT12**  
S.....1-5200  
S.....5298-6300

 **FH FLIP**  
**HU46FH**  
S.....5298-6300  
S.....1-5200

 **TE KEY**  
**HU100TE**  
Z.....1-2000  
Z.....2001-4000  
Z.....4001-6000

 **MH KEY**  
**HU100MH**  
Z.....1-2000  
Z.....2001-4000  
Z.....4001-6000

 **FH FLIP**  
**HU100FH**  
Z.....1-2000  
Z.....2001-4000  
Z.....4001-6000  
.....0001-3679

HUF - VALEO

WITTE

VALEO

VALEO





FOR:  
PER:

# PEUGEOT



P304



.....1/9...A/Z A/Z M.N.P.R.S  
.....0/90/9 M.N.P.R.S  
.....1/9...A/Z M.N.P.R.S  
.....1/9...A/Z M.N.P.R.S  
.....1/9...A/Z M.N.P.R.S  
.....1/9...A/Z M.N.P.R.S  
.....1/9...A/Z M.N.P.R.S



NE72AT29



NE72AT14



NE72AT5

VALEO



P265

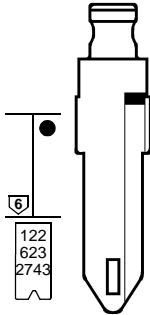

122  
623  
2743



NE72FH

..... 1/9 . . . A/Z A/Z MNPRS  
..... . 0/90/9 MNPRS  
..... 1/9 . . . A/Z MNPRS  
..... 1/9 . . . A/Z MNPRS  
..... 1/9 . . . A/Z MNPRS  
..... 1/9 . . . A/Z MNPRS  
..... 1/9 . . . A/Z MNPRS



P443

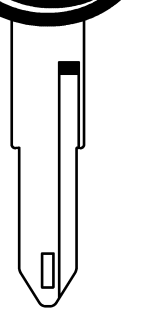
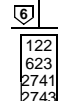

122  
623  
2741  
2743



NE73TE

..... M-N-P-R-S



NE73MH

..... M-N-P-R-S

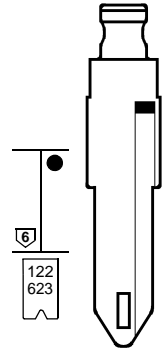

122  
623



NE73FH

..... M-N-P-R-S

FOR:  
PER:

# PEUGEOT



P443



S823  
S830  
S681  
S850  
S860  
S903  
S1336

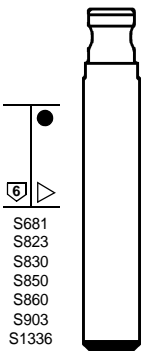

S681  
S823  
S830  
S850  
S860  
S903  
S1336



P386



S620  
S1117



P454



S620  
S767  
S1117



P443



S620  
S1117

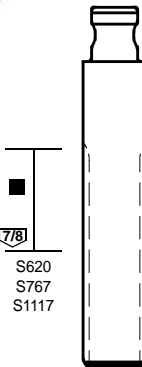

S620  
S767  
S1117



VA6MH

..... 1234Q5678H  
..... ABCDEF  
..... 12897-A9999



VA6FH

..... 12897-A9999  
..... ABCDEF  
..... 1234Q5678H



HU83T14

..... 1-2000



HU83TE



HU83MH

..... 1-2000



HU83FH

..... 1-2000

HUF - VALEO

VALEO



FOR:  
PER:

# PEUGEOT

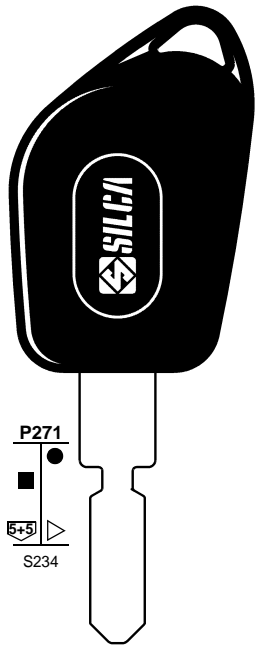

P271  
S234

**NE78P**  
.....  
0123456789  
ABCDEF

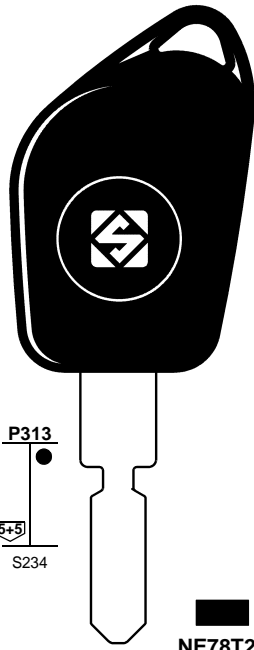

P313  
S234

**NE78T5**  
.....  
0123456789  
ABCDEF

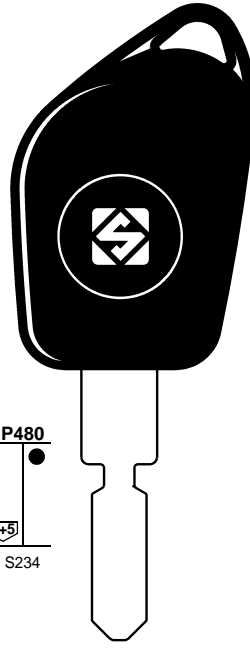

P480  
S234

**NE78TE**  
.....  
0123456789  
ABCDEF

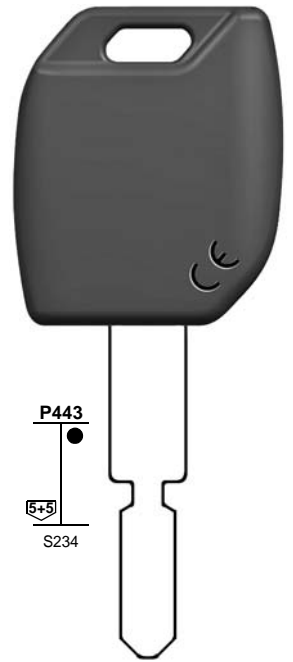

P443  
S234

**NE78MH**  
.....  
0123456789ABCDEF

**NE78T29**  
.....  
0123456789  
ABCDEF

VALEO

NEIMAN

FOR:  
PER:

# PEUGEOT

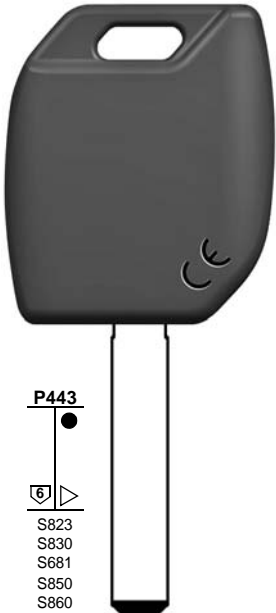

P443  
S823  
S830  
S861  
S850  
S860  
S903  
S1336

**VA6MH**  
..... 1234Q5678H  
..... ABCDEF  
..... 12897-A9999

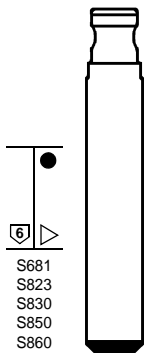

P386  
S681  
S823  
S830  
S850  
S860  
S903  
S1336

**VA6FH**  
..... 12897-A9999  
..... ABCDEF  
..... 1234Q5678H

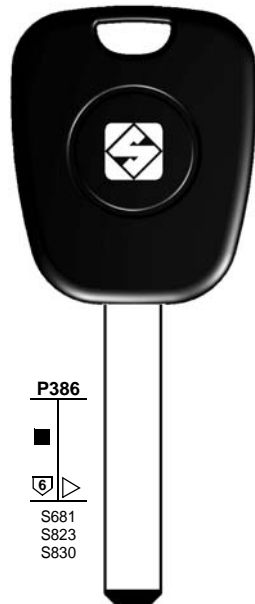

P386  
S681  
S823  
S830

**VA2T14**  
..... 1-2-3-4-Q-5-6-7-8-H  
..... A-B-C-D-E-F

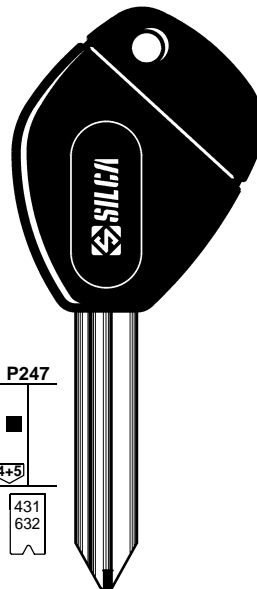

P247  
431  
632

**SX9CP**  
..... 0111111-628888  
..... H  
0111111-628888  
63/99 ..... 1-2-4-6-8  
63/99 ..... H 1-2-4-6-8



P315  
431  
632

**SX9T5**  
..... 0111111-628888  
..... H  
0111111-628888  
63/99 ..... 1-2-4-6-8  
63/99 ..... H 1-2-4-6-8

HUF - VALEO

HUF - VALEO



FOR:  
PER:

# PEUGEOT

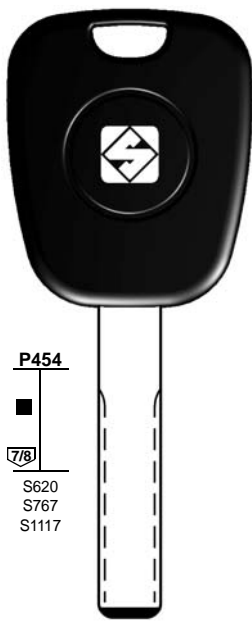

P454  
S620  
S767  
S1117

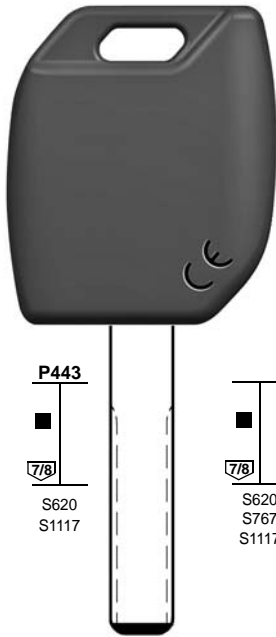

P443  
S620  
S1117

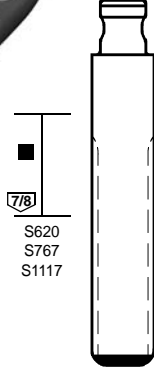

S620  
S767  
S1117

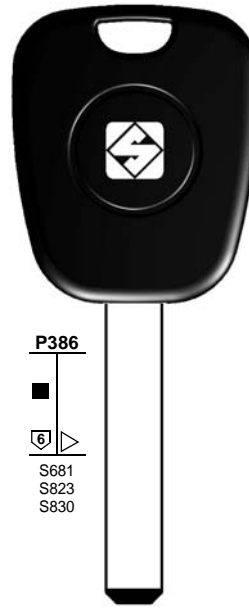

P386  
S681  
S823  
S830

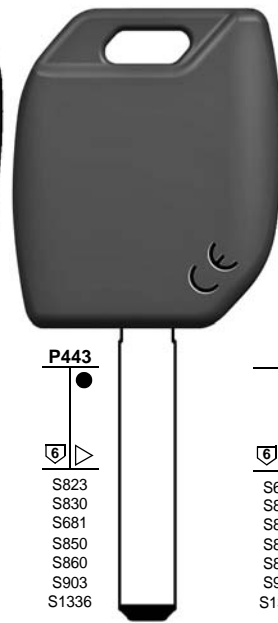

P443  
S823  
S830  
S681  
S850  
S860  
S903  
S1336

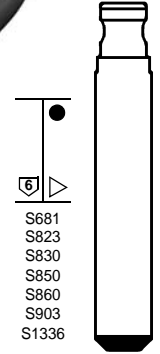

S681  
S823  
S830  
S850  
S860  
S903  
S1336

**HU83TE**  
..... 1-2000

**HU83MH**  
..... 1-2000

**HU83FH**  
..... 1-2000

**VA2T14**  
..... 1-2-3-4-Q-5-6-7-8-H  
..... A-B-C-D-E-F

**VA6MH**  
..... 1234Q5678H  
..... ABCDEF  
..... 12897-A9999

**VA6FH**  
..... 12897-A9999  
..... ABCDEF  
..... 1234Q5678H

**HU83T14**  
..... 1-2000  
(head code P386)

VALEO

VALEO

HUF - VALEO

HUF - VALEO

FOR:  
PER:

# PEUGEOT

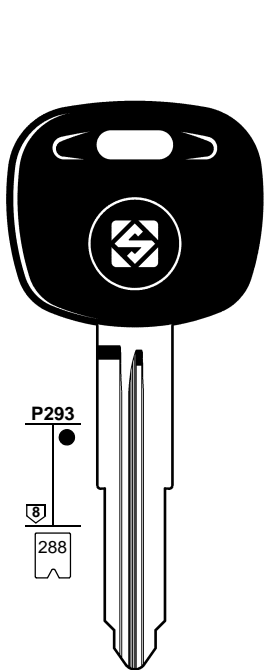

P293  
288

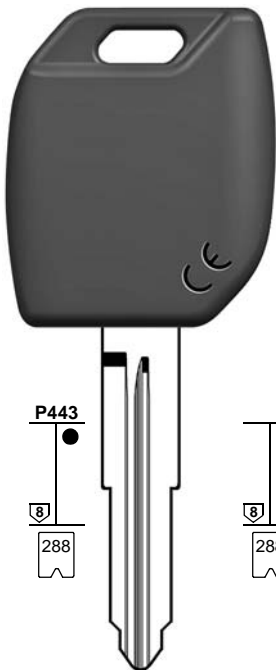

P443  
288

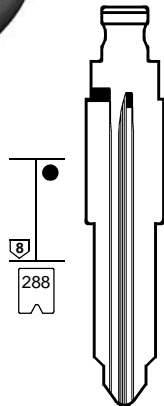

288

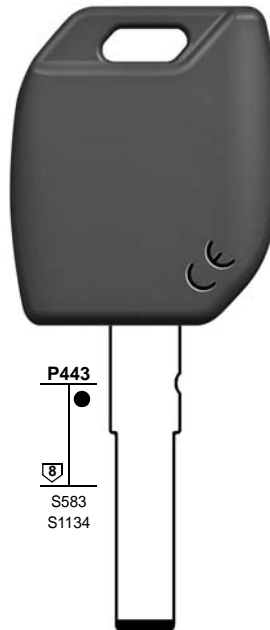

P443  
S583  
S1134

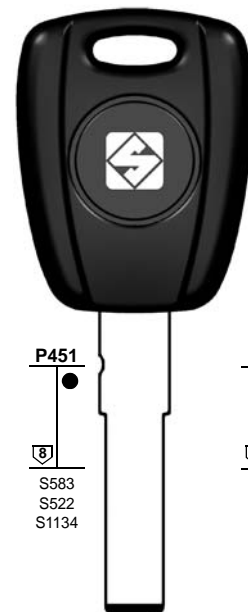

P451  
S583  
S522  
S1134

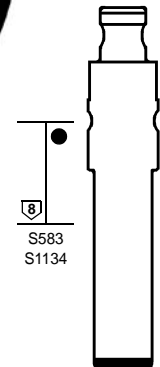

S583  
S1134

**MIT11RTE**  
..... 30010-32009

**MIT11RMH**  
..... 30010-32009

**MIT11RFH**  
..... 30010-32009

**SIP22MH**  
DE ..... 1-11210

**SIP22TE**  
DE ..... 1-11210

**SIP22FH**  
DE ..... 1-11210

GIOBERT - TRW SIPEA

GIOBERT - TRW SIPEA



FOR:  
PER:

# PEUGEOT

Blue head  
Testa blu



P266



P456

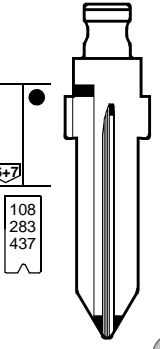

P443

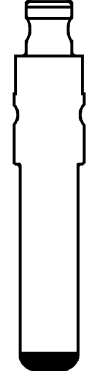

P451

Blue head  
Testa blu

108  
283  
437

122  
2743

108  
283  
437

S583

S522  
S583  
S1134

S583  
S1134

TE  
KEY

FH  
FLIP

MH  
KEY

TE  
KEY

FH  
FLIP

**GT10BT5**  
 .... 3001-4000  
 .... 6001-7000  
 J .... 3001-6732  
 N .... 6001-7000  
 V .... 1-3056  
 AB .... 5001-8058  
 AB .... 6001-6891

**GT10BTE**  
 .... 1/9 ... A/Z/AZ MNPRS  
 .... 0/90/9 MNPRS  
 J .... 1/9 ... A/Z MNPRS  
 N .... 1/9 ... A/Z MNPRS  
 V .... 1/9 ... A/Z MNPRS  
 AB .... 1/9 ... A/Z MNPRS  
 .... 1/9 ... A/Z MNPRS  
 .... 3001-4000  
 .... 6001-7000

**GT10FH**  
 J .... 3001-6732  
 N .... 6001-7000  
 V .... 0001-3056  
 AB .... 5001-8058  
 AB .... 6001-6891  
 .... 3001-4000  
 .... 6001-7000

**GIOBERT - TRW SIPEA**

**GIOBERT - TRW SIPEA**

**GIOBERT - TRW SIPEA**

FOR:  
PER:

# PEUGEOT



P247



P315



P449



P443



P386

431  
632

431  
632

431  
632

431  
632

431  
632

S620  
S767  
S1117

SX9CP

SX9T5

SX9T14

SX9TE

SX9MH

HU83T14  
 .... 1-2000

TE  
KEY

MH  
KEY

0111111-628888  
 ..... H  
 0111111-628888  
 63/99 ..... 1-2-4-6-8  
 63/99 ..... H 1-2-4-6-8

0111111-628888  
 ..... H  
 0111111-628888  
 63/99 ..... 1-2-4-6-8  
 63/99 ..... H 1-2-4-6-8

0111111-628888  
 ..... H  
 0111111-628888  
 63/99 ..... 1-2-4-6-8  
 63/99 ..... H 1-2-4-6-8

0111111-628888  
 ..... H  
 0111111-628888  
 63/99 ..... 1-2-4-6-8  
 63/99 ..... H 1-2-4-6-8

**SIMPLEX**

**VALEO**





FOR:  
PER:

# PEUGEOT

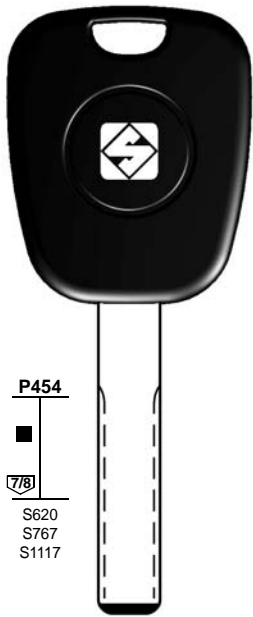

P454

■  
7/8  
S620  
S767  
S1117

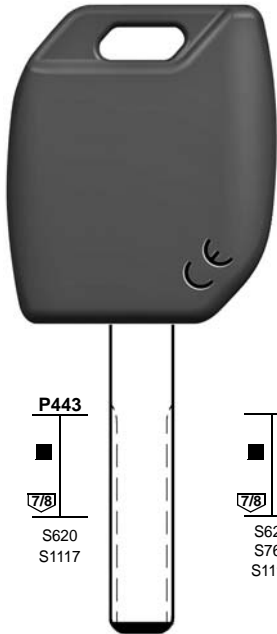

P443

■  
7/8  
S620  
S1117

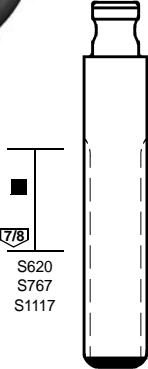

■  
7/8  
S620  
S767  
S1117

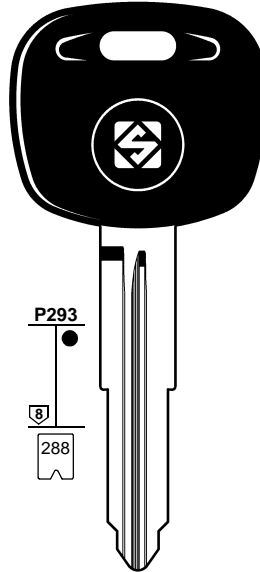

P293

■  
8  
288

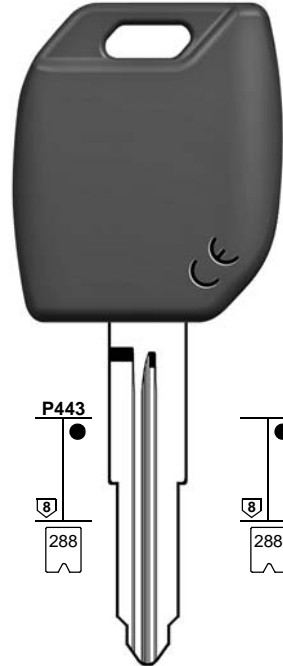

P443

■  
8  
288

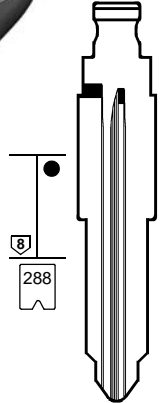

■  
8  
288

**TE KEY**  
**HU83TE**  
..... 1-2000

**MH KEY**  
**HU83MH**  
..... 1-2000

**FH FLIP**  
**HU83FH**  
..... 1-2000

**TE KEY**  
**MIT11RTE**  
..... 30010-32009

**MH KEY**  
**MIT11RMH**  
..... 30010-32009

**FH FLIP**  
**MIT11RFH**  
..... 30010-32009

VALEO

VALEO

FOR:  
PER:

# PEUGEOT

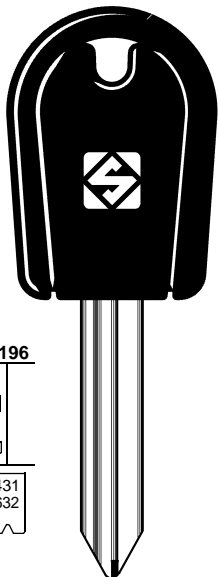

P196

■  
4+5  
431  
632

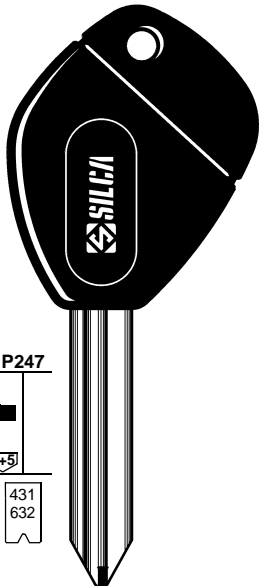

P247

■  
4+5  
431  
632



P315

■  
4+5  
431  
632

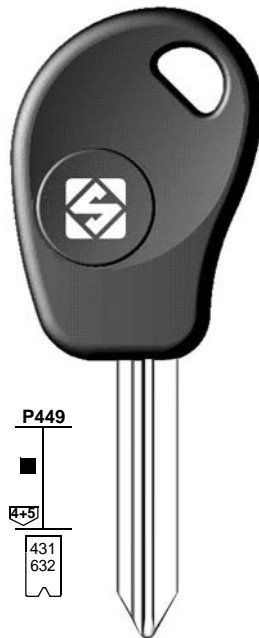

P449

■  
4+5  
431  
632

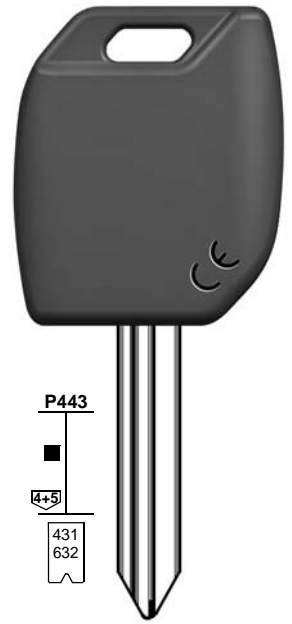

P443

■  
4+5  
431  
632

.....  
0111111-62888  
..... H  
0111111-62888  
63/99 ..... 1-2-4-6-8  
63/99 ..... H 1-2-4-6-8

.....  
0111111-62888  
..... H  
0111111-62888  
63/99 ..... 1-2-4-6-8  
63/99 ..... H 1-2-4-6-8

.....  
0111111-62888  
..... H  
0111111-62888  
63/99 ..... 1-2-4-6-8  
63/99 ..... H 1-2-4-6-8

.....  
0111111-62888  
..... H  
0111111-62888  
63/99 ..... 1-2-4-6-8  
63/99 ..... H 1-2-4-6-8

.....  
0111111-62888  
..... H  
0111111-62888  
63/99 ..... 1-2-4-6-8  
63/99 ..... H 1-2-4-6-8

**SX9GP**

**SX9CP**

**SX9T5**

**SX9T14**

**SX9TE**

**SX9MH**

SIMPLEX



SIMPLEX

SIMPLEX

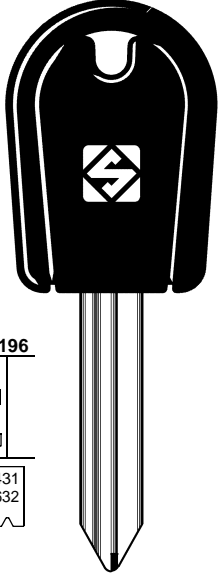
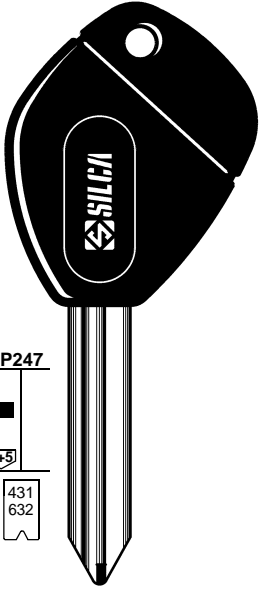

FOR:  
PER:

# PEUGEOT

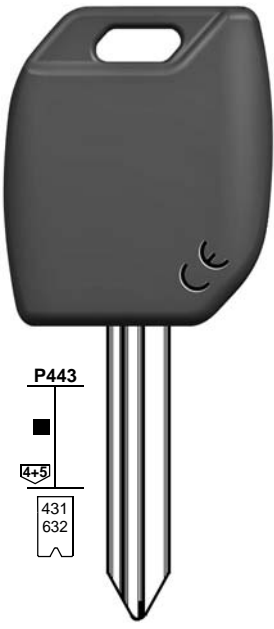
 <p><b>P196</b></p> <p>4+5</p> <p>431 632</p> <p>..... 0111111-628888 ..... H 0111111-628888 63/99 ..... 1-2-4-6-8 63/99 ..... H 1-2-4-6-8</p>	 <p><b>P247</b></p> <p>4+5</p> <p>431 632</p> <p>..... 0111111-628888 ..... H 0111111-628888 63/99 ..... 1-2-4-6-8 63/99 ..... H 1-2-4-6-8</p>	 <p><b>P315</b></p> <p>4+5</p> <p>431 632</p> <p>..... 0111111-628888 ..... H 0111111-628888 63/99 ..... 1-2-4-6-8 63/99 ..... H 1-2-4-6-8</p>	 <p><b>P449</b></p> <p>4+5</p> <p>431 632</p> <p>..... 0111111-628888 ..... H 0111111-628888 63/99 ..... 1-2-4-6-8 63/99 ..... H 1-2-4-6-8</p>	 <p><b>P443</b></p> <p>4+5</p> <p>431 632</p> <p>..... 0111111-628888 ..... H 0111111-628888 63/99 ..... 1-2-4-6-8 63/99 ..... H 1-2-4-6-8</p>
---	---	---	--	---



SIMPLEX

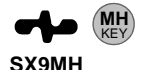

SIMPLEX

SIMPLEX

FOR:  
PER:

# PEUGEOT

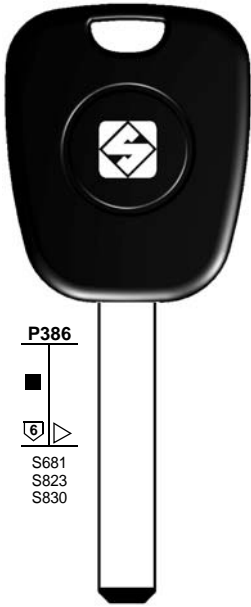
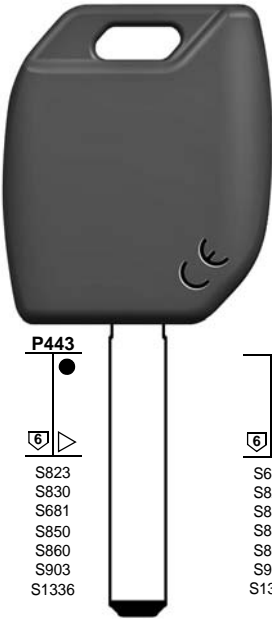
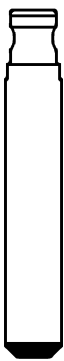
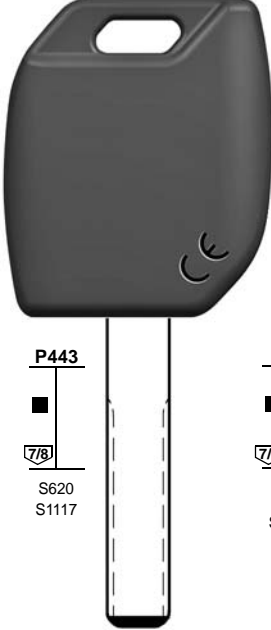
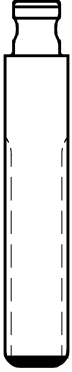
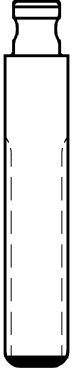
 <p><b>P386</b></p> <p>6</p> <p>S681 S823 S830</p> <p>..... <b>VA2T14</b> ..... 1-2-3-4-Q-5-6-7-8-H ..... A-B-C-D-E-F</p>	 <p><b>P443</b></p> <p>6</p> <p>S823 S830 S681 S850 S860 S903 S1336</p> <p>..... <b>VA6MH</b> ..... 1234Q5678H ..... ABCDEF ..... 12897-A9999</p>	 <p><b>P454</b></p> <p>7/8</p> <p>S620 S767 S1117</p> <p>..... <b>VA6FH</b> ..... 12897-A9999 ..... ABCDEF ..... 1234Q5678H</p>	 <p><b>P443</b></p> <p>7/8</p> <p>S620 S1117</p> <p>..... <b>HU83TE</b> ..... 1-2000</p>	 <p><b>P443</b></p> <p>7/8</p> <p>S620 S767 S1117</p> <p>..... <b>HU83MH</b> ..... 1-2000</p>	 <p><b>P443</b></p> <p>7/8</p> <p>S620 S767 S1117</p> <p>..... <b>HU83FH</b> ..... 1-2000</p>
---	--	--	---	--	--



HUF - VALEO

HUF - VALEO



FOR:  
PER:

## PEUGEOT

## PIAGGIO

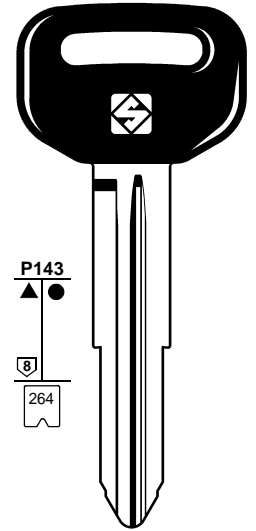
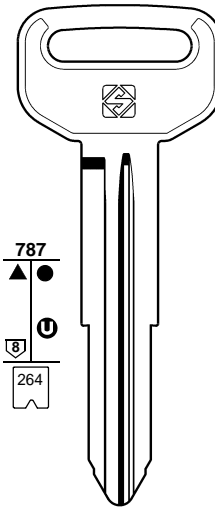
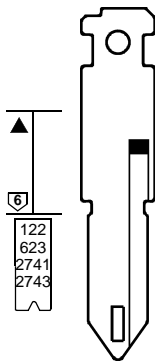
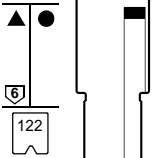
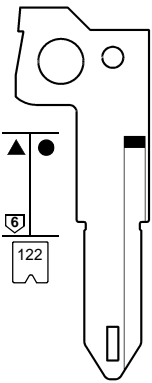

**NE73-BI**

... 1/9 .....  
1/9 ..... A/Z  
... 1/9 ..... A/Z  
... 1/9 ..... A/Z  
... 1/9 ..... A/Z  
... 1/9 ..... A/Z  
... 1/9 ..... A/Z  
... 1/9 ..... A/Z  
... 1/9 ..... A/Z  
... 1/9 ..... A/Z  
... 0/9 0/9  
M-N-P-R-S

**NE73-CI**

... 1/9 .....  
1/9 ..... A/Z  
... 1/9 ..... A/Z  
... 1/9 ..... A/Z  
... 1/9 ..... A/Z  
... 1/9 ..... A/Z  
... 1/9 ..... A/Z  
... 1/9 ..... A/Z  
... 1/9 ..... A/Z  
... 1/9 ..... A/Z  
... 0/9 0/9  
M-N-P-R-S

**VA3-I**

... 1/9 .....  
1/9 ..... A/Z  
... 1/9 ..... A/Z  
... 1/9 ..... A/Z  
... 1/9 ..... A/Z  
... 1/9 ..... A/Z  
... 1/9 ..... A/Z  
... 1/9 ..... A/Z  
... 1/9 ..... A/Z  
... 1/9 ..... A/Z  
... 0/9 0/9  
M-N-P-R-S

**HU83T**

.... 1-2000

**DH4R**

D .... 1-3000

**DH4RP**

D .... 1-3000



NEIMAN - VACHETTE



VALEO

FOR:  
PER:

## PLYMOUTH

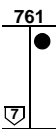
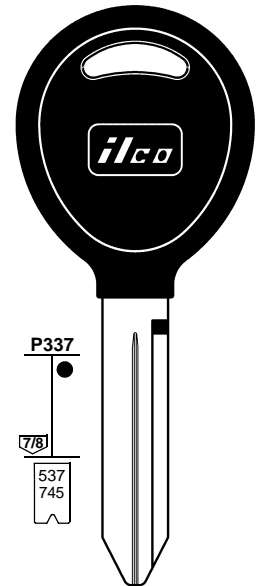
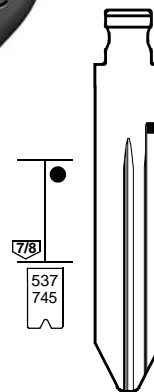
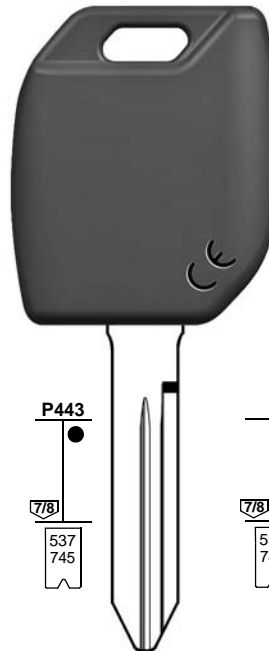
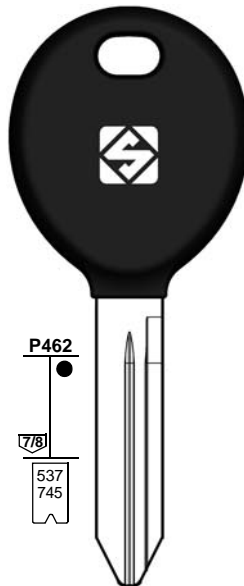
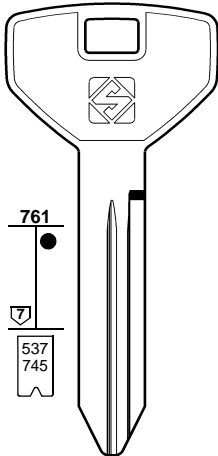
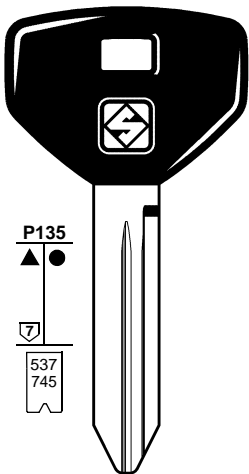

**CY22P**

M .... 1-2618  
FL .... 1-262  
L .... 1-3580

**CY23**

M .... 1-2618  
L .... 1-3580

**CY24TE**

L .... 1-3580  
M .... 1-2618

**CY24MH**

L .... 1-3580  
M .... 1-2618

**CY24FH**

L .... 1-3580  
M .... 1-2618  
FT .... 1001-3000

**Y160-PT**

L .... 1-3580  
M .... 1-2618



FOR:  
PER:

# PONTIAC

Grey head  
Testa grigia

P233  
567  
Primary

P339  
567  
Master

P339  
567  
Valet

P340  
567  
Master

P340  
567  
Valet

P339  
2020

..... AA00-7T51  
..... S000A-S711K

..... 1-1988  
H ..... 1-3988  
O ..... 5000-6999  
..... S000A-S711K

..... 1-1988  
H ..... 1-3988  
O ..... 5000-6999  
..... S000A-S711K

O ..... 5000-6999

O ..... 5000-6999

G ..... 0-3631

**GM39EP**

**B99-PT**

**B100-PT**

**B104-PT**

**B103-PT**

**B111-PT**

**B99-PT5**

**B100-PT5**

**B104-PT5**

**B103-PT5**

**BRIGGS & STRATTON**

**BRIGGS & STRATTON**

**BRIGGS & STRATTON**

FOR:  
PER:

# PONTIAC

P310  
110

P452  
S882

P443  
S882

P442  
S882

**DWO4RT6**  
J ..... 1-1200

**DWO4RFH**  
J ..... 1-1200  
T ..... 1-1200  
M ..... 1-1200

**GM45TE**  
60000-62113

**GM45MH**  
60000-62113

**GM45FH**  
60000-62113

**EK3P-GM45**  
60000-62113

**BRIGGS & STRATTON**

**BRIGGS & STRATTON**





FOR:  
PER:

# PONTIAC

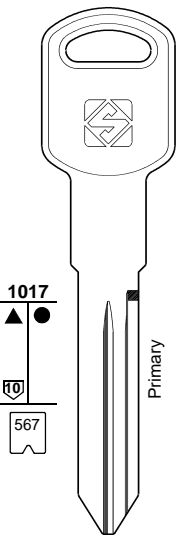

..... AA00-7T51  
..... S000A-S711K

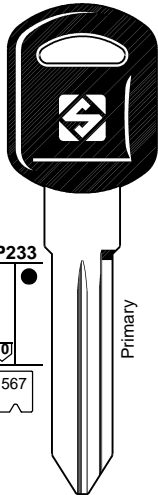

..... AA00-7T51  
..... S000A-S711K

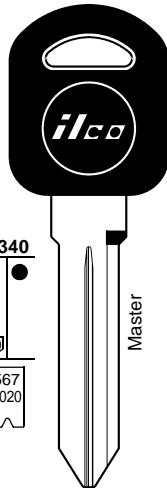

..... 1-1988  
H..... 1-3988  
O..... 5000-6999  
..... S000A-S711K

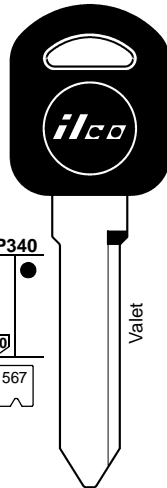

..... 1-1988  
H..... 1-3988  
O..... 5000-6999  
..... S000A-S711K

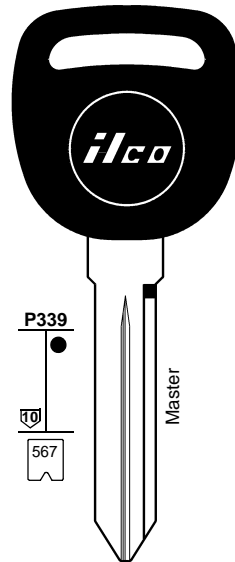

..... 1-1988  
H..... 1-3988  
O..... 5000-6999  
..... S000A-S711K

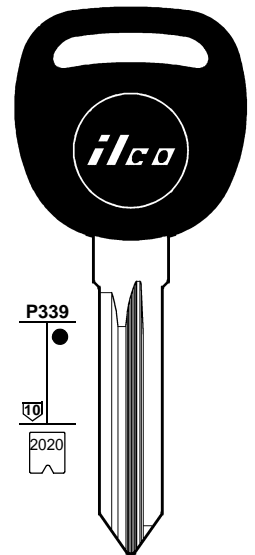
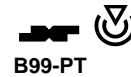

G..... 0-3631



B97-PT5



B98-PT5



B99-PT5

BRIGGS & STRATTON

BRIGGS & STRATTON

FOR:  
PER:

# PONTIAC

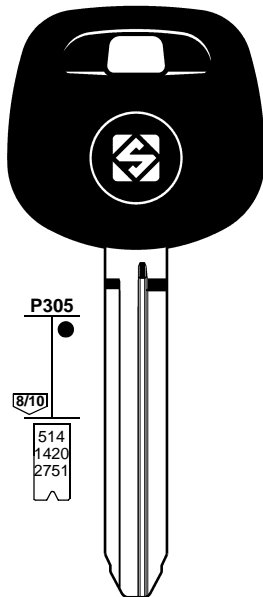

TOY43AT31

..... 10001-15000  
..... 50000-59999  
..... 60000-69999



TOY43ATE

..... 10001-15000  
..... 50000-59999  
..... 60000-69999

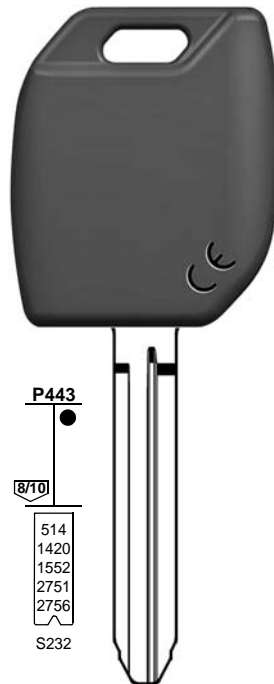

TOY43MH

..... 10001-15000  
..... 50000-59999  
..... 60000-69999  
..... 25001-26200  
..... 1-5000

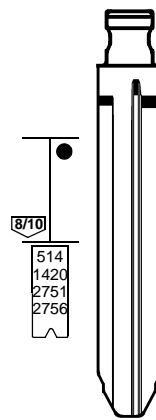

TOY43FH

..... 10001-15000  
..... 50000-59999  
..... 60000-69999  
..... 25001-26200



FOR:  
PER:

# PORSCHE

# PROTON

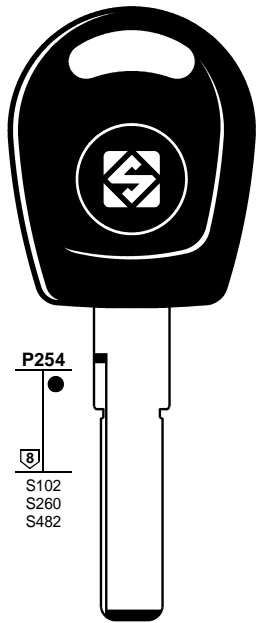

P254

S102  
S260  
S482

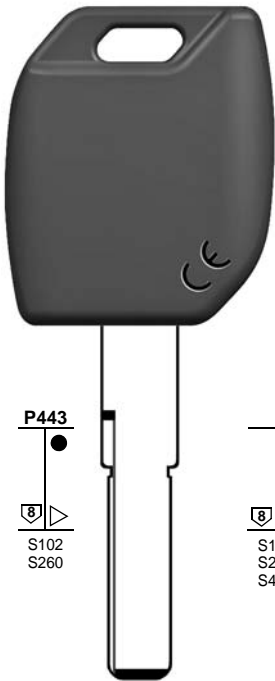

P443

S102  
S260

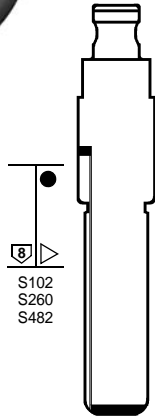

S102  
S260  
S482

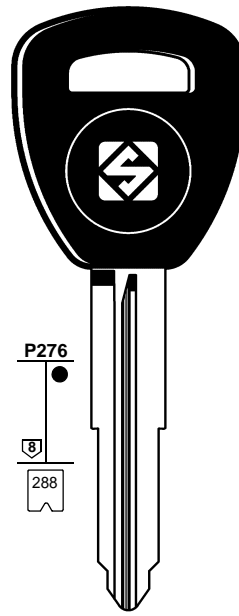

P276

288

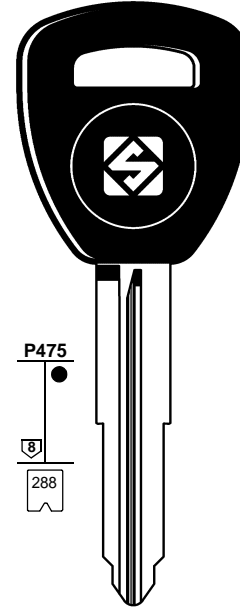

P475

288

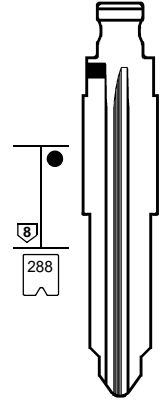

288

  
**HU66T5**  
1ATS ..... 00001-17850  
..... 1-2000  
..... 1-6000

  
**HU66MH**  
..... 1-2000  
..... 0001-6000

  
**HU66FH**  
..... 1-2000  
..... 0001-6000

  
**PO1RT4**  
..... 30010-32009

  
**PO1RTE**  
..... 30010-32009

  
**PO1RFH**  
..... 30010-32009

HUF - WITTE

HUF - WITTE

FOR:  
PER:

# PROTON

# RENAULT

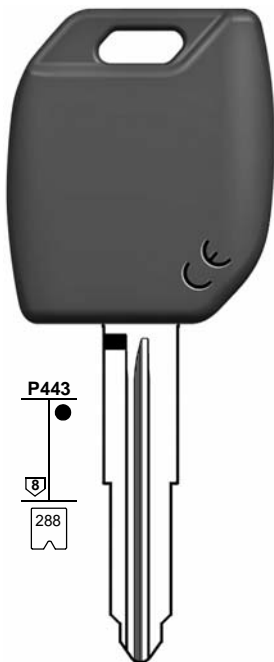

P443

288

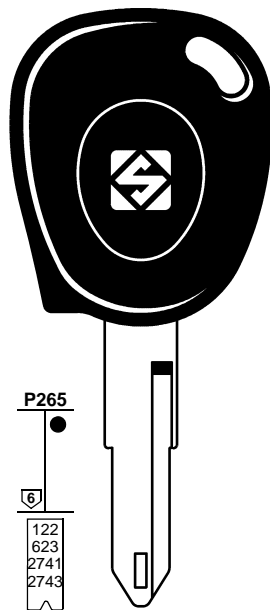

P265

122  
623  
2741  
2743

M-N-P-R-S



P443

122  
623  
2741  
2743

  
**NE73MH**  
..... M-N-P-R-S

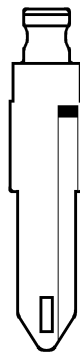

122  
623

  
**NE73FH**  
..... M-N-P-R-S

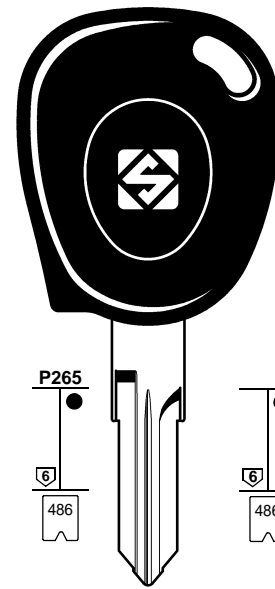

P265

486

  
**VAC102T1**  
..... 0/90/9 12345  
..... A/Z0/9 1-4092  
..... A/Z0/9 5001-9092

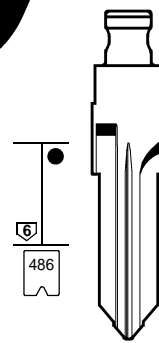

486

  
**VAC102FH**  
..... 0/90/9 12345  
..... A/Z0/9 1-4092  
..... A/Z0/9 5001-9092

  
**PO1RMH**  
..... 30010-32009

  
**NE73T5**  
  
**NE73T16**

  
**NE73TE**

VALEO

VALEO

VALEO



FOR:  
PER:

# RENAULT

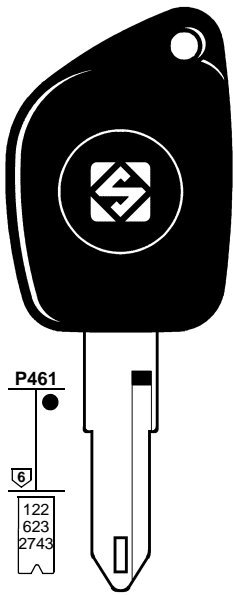

P461  
6  
122  
623  
2743



### NE72ATE

..... 1/9 . . A/A/Z MNPRS  
..... 0/90/9 MNPRS  
..... 1/9 . . A/Z MNPRS  
..... 1/9 . . A/Z MNPRS  
..... 1/9 . . A/Z MNPRS  
..... 1/9 . . A/Z MNPRS  
..... 1/9 . . A/Z MNPRS  
..... 1/9 . . A/Z MNPRS

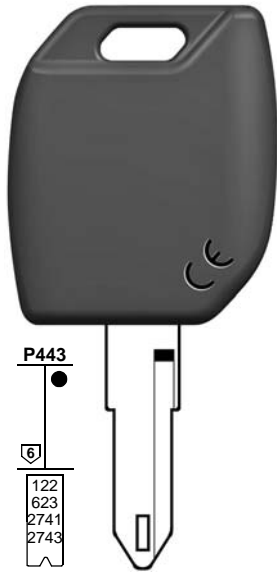

P443  
6  
122  
623  
2741  
2743



### NE72MH

..... M-N-P-R-S  
..... 0/90/9 MNPRS  
..... 1/9 . . A/Z MNPRS  
..... 1/9 . . A/Z MNPRS  
..... 1/9 . . A/A/Z MNPRS  
..... 1/9 . . A/Z MNPRS  
..... 1/9 . . A/Z MNPRS  
..... 1/9 . . A/Z MNPRS  
..... 1/9 . . A/Z MNPRS

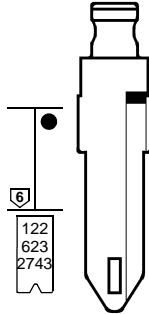

6  
122  
623  
2743



### NE72FH

..... 1/9 . . A/A/Z MNPRS  
..... 0/90/9 MNPRS  
..... 1/9 . . A/Z MNPRS  
..... 1/9 . . A/Z MNPRS  
..... 1/9 . . A/Z MNPRS  
..... 1/9 . . A/Z MNPRS  
..... 1/9 . . A/Z MNPRS  
..... 1/9 . . A/Z MNPRS

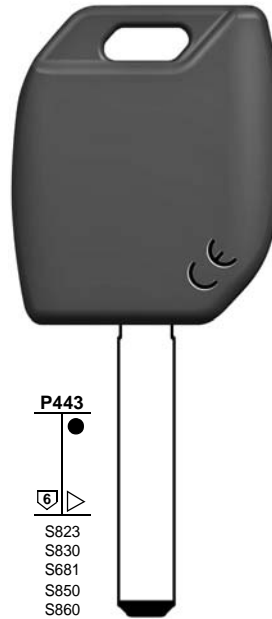

P443  
6  
S823  
S830  
S681  
S850  
S860  
S903  
S1336



### VA6MH

..... 1234Q5678H  
..... ABCDEF  
..... 12897-A9999

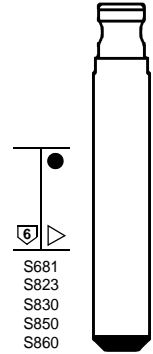

6  
S681  
S823  
S830  
S850  
S860  
S903  
S1336



### VA6FH

..... 12897-A9999  
..... ABCDEF  
..... 1234Q5678H

VALEO

HUF - VALEO

FOR:  
PER:

# RENAULT

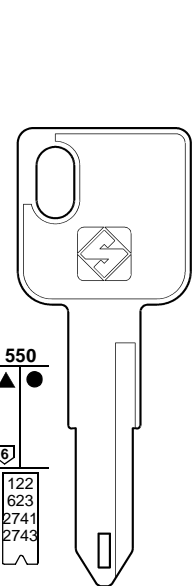

550  
6  
122  
623  
2741  
2743

### NE73

..... 1/9 . . A/Z MNPRS  
..... 0/90/9 MNPRS  
..... 1/9 . . A/Z MNPRS  
..... 1/9 . . A/A/Z MNPRS  
..... 1/9 . . A/Z MNPRS  
..... 1/9 . . A/Z MNPRS  
..... 1/9 . . A/Z MNPRS  
..... 1/9 . . A/Z MNPRS

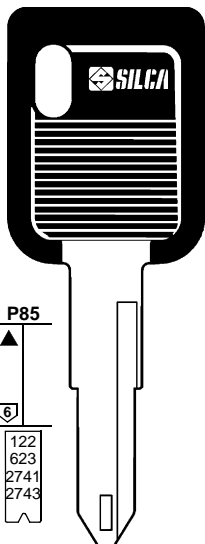

P85  
6  
122  
623  
2741  
2743

### NE73DP

..... 1/9 . . A/Z MNPRS  
..... 0/90/9 MNPRS  
..... 1/9 . . A/Z MNPRS  
..... 1/9 . . A/A/Z MNPRS  
..... 1/9 . . A/Z MNPRS  
..... 1/9 . . A/Z MNPRS  
..... 1/9 . . A/Z MNPRS  
..... 1/9 . . A/Z MNPRS

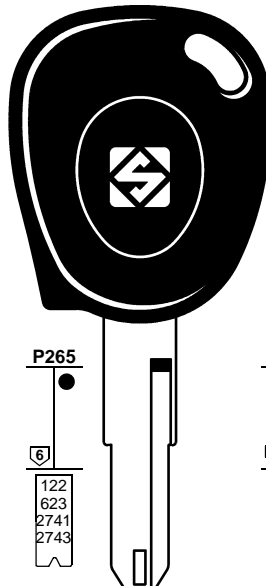

P265  
6  
122  
623  
2741  
2743

### NE73T5

M-N-P-R-S

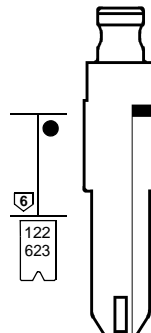

6  
122  
623

### NE73FH

M-N-P-R-S

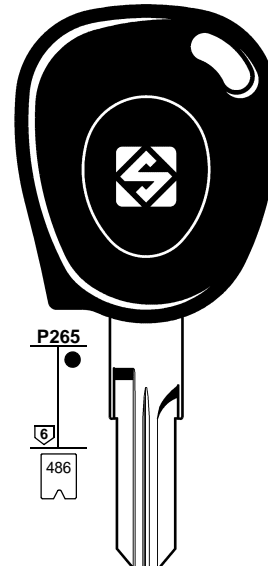

P265  
6  
486

### VAC102T1

..... 0/90/9 12345  
..... A/Z0/9 1-4092  
..... A/Z0/9 5001-9092

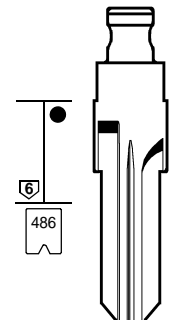

6  
486

### VAC102FH

..... 0/90/9 12345  
..... A/Z0/9 1-4092  
..... A/Z0/9 5001-9092

VALEO



FOR:  
PER:

# RENAULT

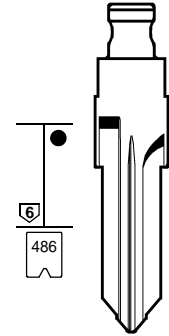
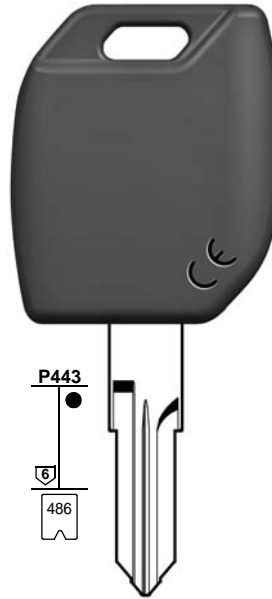
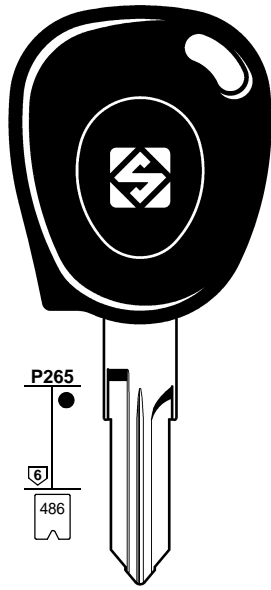
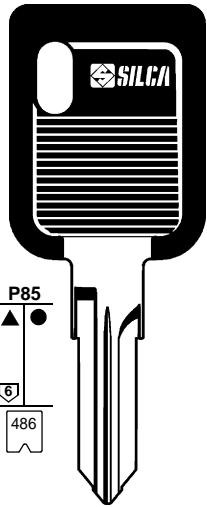

### VAC102DP

..... A/Z0/9 5001-9092  
..... 0/90/9 12345  
..... A/Z0/9 1-4092



### VAC102T1

..... 0/90/9 12345  
..... A/Z0/9 1-4092  
..... A/Z0/9 5001-9092



### VAC102TE

..... A/Z 0/9 1-4092  
..... A/Z 0/9 5001-9092  
..... 0/90/9 12345



### VAC102MH

..... A/Z 0/9 1-4092  
..... A/Z 0/9 5001-9092  
..... A/Z 0/9 1-2-3-4-5



### VAC102FH

..... A/Z 0/9 1-4092  
..... A/Z 0/9 5001-9092

VALEO

VALEO

FOR:  
PER:

# RENAULT

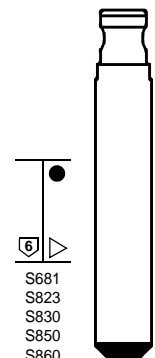
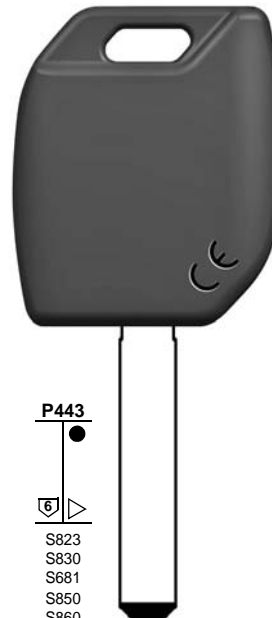
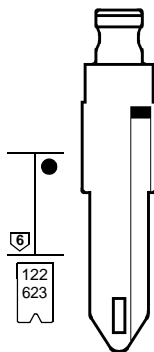
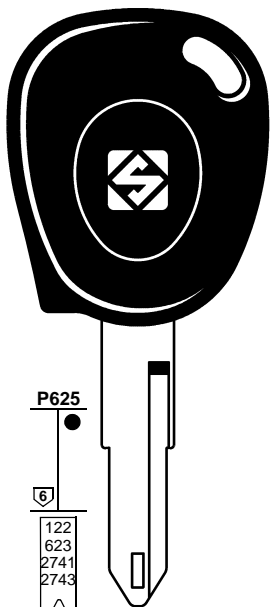

### NE73T5

..... M-N-P-R-S



### NE73T32

..... M-N-P-R-S



### NE73FH

..... M-N-P-R-S



### VA6MH

..... 1234Q5678H  
..... ABCDEF  
..... 12897-A9999



### VA6FH

..... 12897-A9999  
..... ABCDEF  
..... 1234Q5678H

NEIMAN - VALEO

HUF - VALEO





FOR:  
PER:

# RENAULT

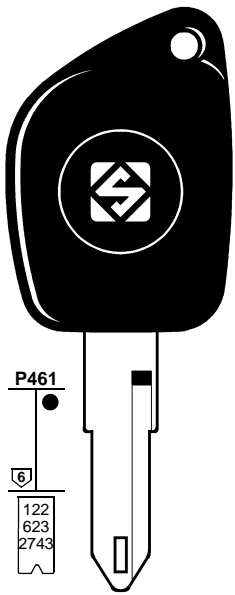

P461

122  
623  
2743



## NE72ATE

..... 1/9 . . . A/ZA/Z MNPRS  
..... 0/90/9 MNPRS  
..... 1/9 . . . A/Z MNPRS  
..... 1/9 . . . A/Z MNPRS  
..... 1/9 . . . A/Z MNPRS  
..... 1/9 . . . A/Z MNPRS  
..... 1/9 . . . A/Z MNPRS  
..... 1/9 . . . A/Z MNPRS

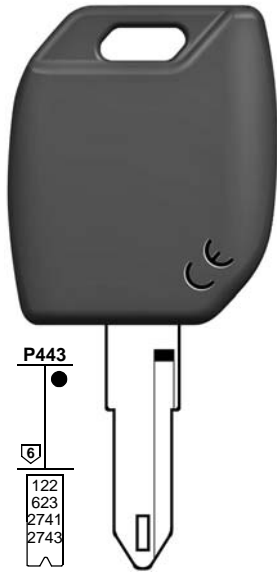

P443

122  
623  
2741  
2743



## NE72MH

..... M-N-P-R-S  
..... 0/90/9 MNPRS  
..... 1/9 . . . A/Z MNPRS  
..... 1/9 . . . A/Z MNPRS  
..... 1/9 . . . A/ZA/Z MNPRS  
..... 1/9 . . . A/Z MNPRS  
..... 1/9 . . . A/Z MNPRS  
..... 1/9 . . . A/Z MNPRS

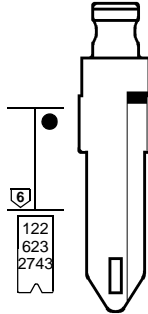

122  
623  
2743



## NE72FH

..... 1/9 . . . A/ZA/Z MNPRS  
..... 0/90/9 MNPRS  
..... 1/9 . . . A/Z MNPRS  
..... 1/9 . . . A/Z MNPRS  
..... 1/9 . . . A/Z MNPRS  
..... 1/9 . . . A/Z MNPRS  
..... 1/9 . . . A/Z MNPRS

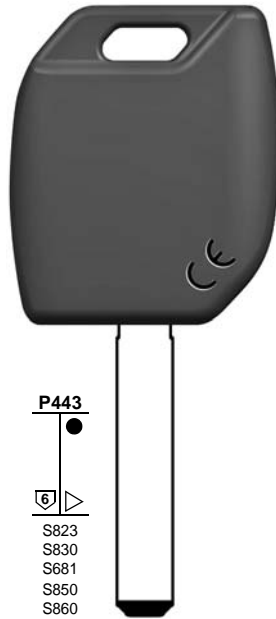

P443

S823  
S830  
S681  
S850  
S860  
S903  
S1336



## VA6MH

..... 1234Q5678H  
..... ABCDEF  
..... 12897-A9999

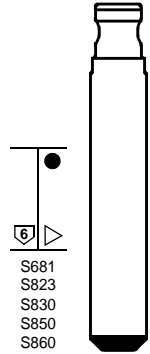

S681  
S823  
S830  
S850  
S860  
S903  
S1336



## VA6FH

..... 12897-A9999  
..... ABCDEF  
..... 1234Q5678H

VALEO

HUF - VALEO

FOR:  
PER:

# RENAULT

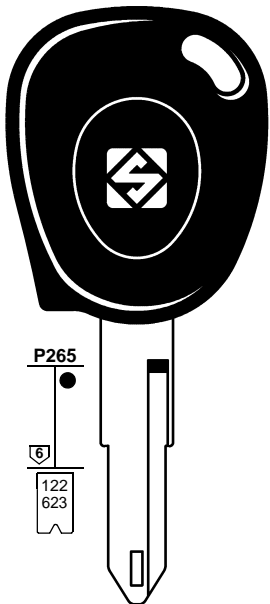

P265

122  
623



## NE73TE

..... M-N-P-R-S

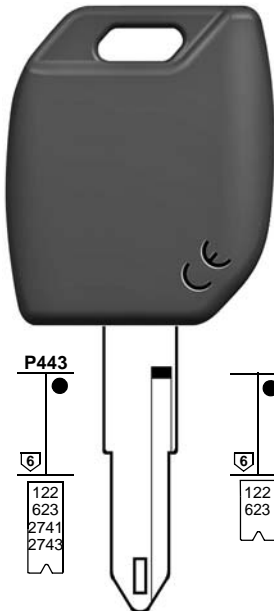

P443

122  
623  
2741  
2743



## NE73MH

..... M-N-P-R-S

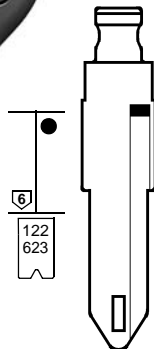

122  
623



## NE73FH

..... M-N-P-R-S

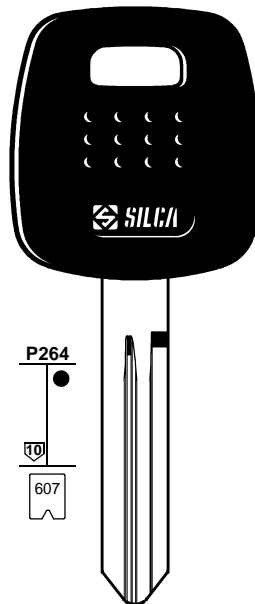

P264

607



## NSN19TE

..... 1-22185  
..... 30001-37850

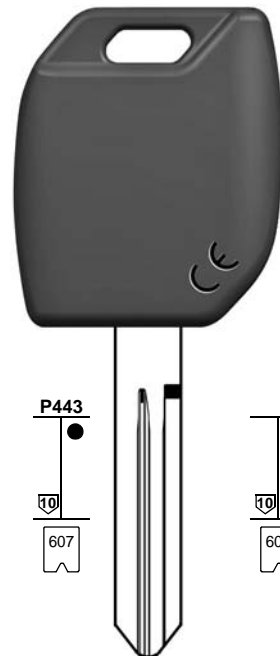

P443

607



## NSN19MH

..... 1-22185  
..... 30001-37850

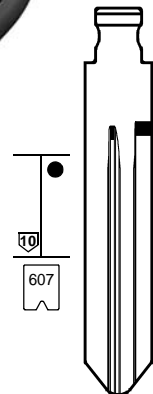

607



## NSN19FH

..... 1-22185  
..... 30001-37850

VALEO

VALEO

VALEO



FOR:  
PER:

# RENAULT

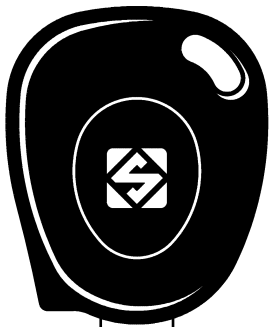

P265

P443

P443

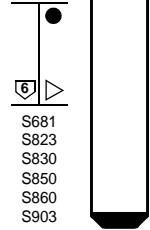
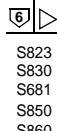
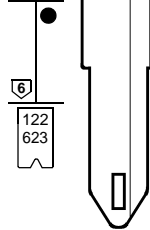
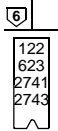
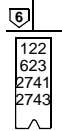

M-N-P-R-S

122  
623  
2741  
2743  
M-N-P-R-S

122  
623

S823  
S830  
S681  
S850  
S860  
S903  
S1336

S681  
S823  
S830  
S850  
S860  
S903  
S1336



NE73T5

NE73T8

NE73MH

NE73FH

VA6MH

VA6FH

NE73T16

NE73T32

NE73TE

..... 1234Q5678H  
..... ABCDEF  
..... 12897-A9999

..... 12897-A9999  
..... ABCDEF  
..... 1234Q5678H

VALEO

VALEO

HUF - VALEO

FOR:  
PER:

# RENAULT

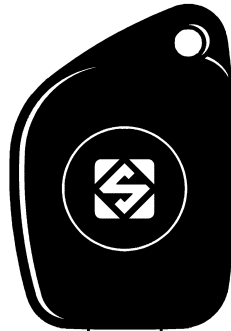
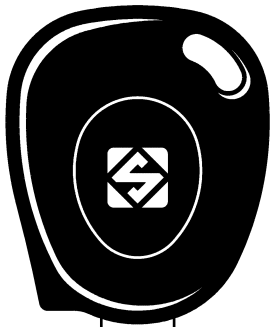

P265

P461

P443

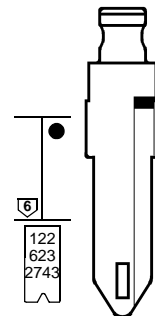
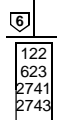
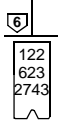
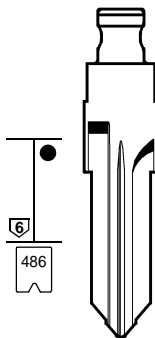
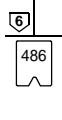

VAC102T1

VAC102FH

NE72ATE

NE72MH

NE72FH

..... 0/90/9 12345  
..... A/Z0/9 1-4092  
..... A/Z0/9 5001-9092

..... 0/90/9 12345  
..... A/Z0/9 1-4092  
..... A/Z0/9 5001-9092

..... 1/9 . . A/Z/AZ MNPRS  
..... 0/90/9 MNPRS  
..... 1/9 . . A/Z MNPRS  
..... 1/9 . . A/Z MNPRS  
..... 1/9 . . A/Z MNPRS  
..... 1/9 . . A/Z MNPRS  
..... 1/9 . . A/Z MNPRS  
..... 1/9 . . A/Z MNPRS  
..... 1/9 . . A/Z MNPRS

..... M-N-P-R-S  
..... 0/90/9 MNPRS  
..... 1/9 . . A/Z MNPRS  
..... 1/9 . . A/Z MNPRS  
..... 1/9 . . A/Z/AZ MNPRS  
..... 1/9 . . A/Z MNPRS  
..... 1/9 . . A/Z MNPRS  
..... 1/9 . . A/Z MNPRS  
..... 1/9 . . A/Z MNPRS  
..... 1/9 . . A/Z MNPRS

..... 1/9 . . A/Z/AZ MNPRS  
..... 0/90/9 MNPRS  
..... 1/9 . . A/Z MNPRS  
..... 1/9 . . A/Z MNPRS  
..... 1/9 . . A/Z MNPRS  
..... 1/9 . . A/Z MNPRS  
..... 1/9 . . A/Z MNPRS  
..... 1/9 . . A/Z MNPRS  
..... 1/9 . . A/Z MNPRS

VALEO

VALEO

VALEO



FOR:  
PER:

# RENAULT

Blue and green head  
Testa blu e verde

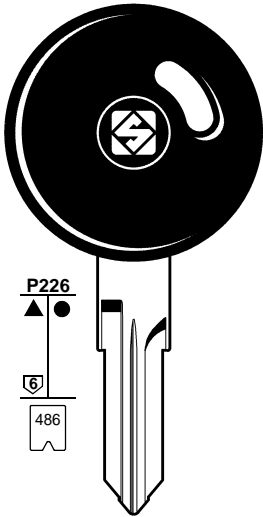

**VAC102GP**  
..... A/Z/0/9 5001-9092  
..... 0/90/9 12345  
..... A/Z/0/9 1-4092

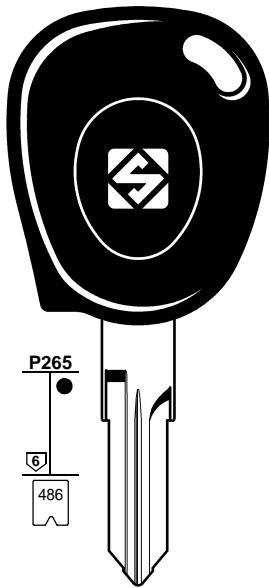

**VAC102T1**  
..... 0/90/9 12345  
..... A/Z/0/9 1-4092  
..... A/Z/0/9 5001-9092

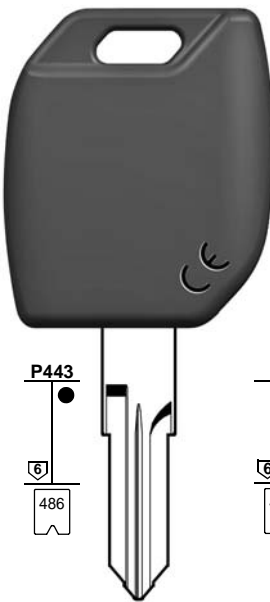

**VAC102MH**  
..... 0/90/9 12345  
..... A/Z/0/9 1-4092  
..... A/Z/0/9 5001-9092

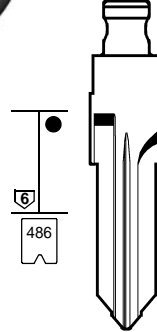

**VAC102FH**  
..... 0/90/9 12345  
..... A/Z/0/9 1-4092  
..... A/Z/0/9 5001-9092

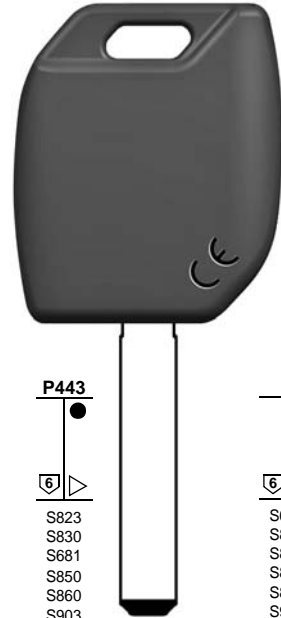

**VA6MH**  
..... 1234Q5678H  
..... ABCDEF  
..... 12897-A9999

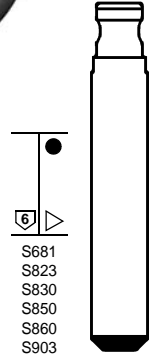

**VA6FH**  
..... 12897-A9999  
..... ABCDEF  
..... 1234Q5678H

**VAC102TE**  
..... 0/90/9 12345  
..... A/Z/0/9 1-4092  
..... A/Z/0/9 5001-9092

VALEO

VALEO

VALEO

HUF - VALEO

FOR:  
PER:

# RENAULT

Blue and green head  
Testa blu e verde

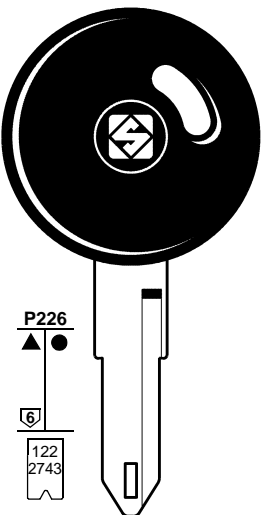

**NE72GP**  
1/9 ..... A/Z MNPRS  
..... 0/90/9 MNPRS  
..... 1/9 .. A/Z MNPRS  
..... 1/9 .. A/Z MNPRS  
..... 1/9 .. A/Z MNPRS  
..... 1/9 .. A/Z MNPRS  
..... 1/9 .. A/Z MNPRS  
..... 1/9 .. A/Z MNPRS

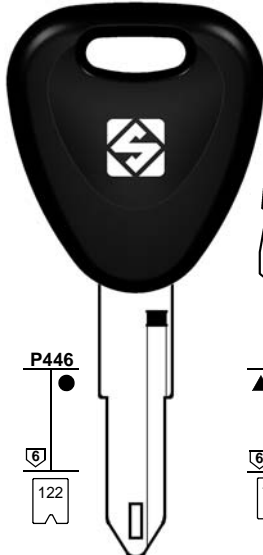

**NE73TP**  
1/9 ..... A/Z MNPRS  
..... 0/90/9 MNPRS  
..... 1/9 .. A/Z MNPRS  
..... 1/9 .. A/Z MNPRS  
..... 1/9 .. A/Z MNPRS  
..... 1/9 .. A/Z MNPRS  
..... 1/9 .. A/Z MNPRS  
..... 1/9 .. A/Z MNPRS

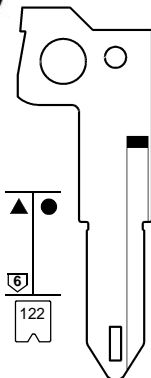

**NE73-BI**  
..... 1/9 .....  
1/9 ..... A/Z  
1/9 ..... A/Z  
1/9 ..... A/Z  
1/9 ..... A/Z  
1/9 ..... A/Z  
1/9 ..... A/Z  
1/9 ..... A/Z  
1/9 ..... A/Z  
..... 0/9 0/9  
M-N-P-R-S

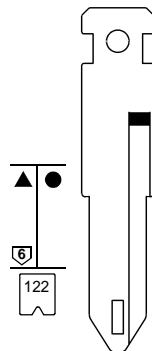

**NE73-CI**  
..... 1/9 .....  
1/9 ..... A/Z  
1/9 ..... A/Z  
1/9 ..... A/Z  
1/9 ..... A/Z  
1/9 ..... A/Z  
1/9 ..... A/Z  
1/9 ..... A/Z  
1/9 ..... A/Z  
..... 0/9 0/9  
M-N-P-R-S

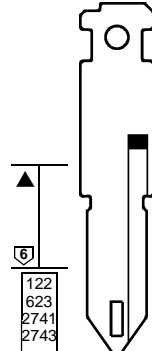

**VA3-I**  
..... 1/9 .....  
1/9 ..... A/Z  
1/9 ..... A/Z  
1/9 ..... A/Z  
1/9 ..... A/Z  
1/9 ..... A/Z  
1/9 ..... A/Z  
1/9 ..... A/Z  
1/9 ..... A/Z  
..... 0/9 0/9  
M-N-P-R-S

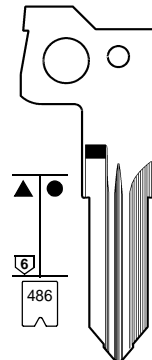

**VAC102-BI**  
..... A/Z 0/9 1-4092  
..... A/Z 0/9 5001-9092  
..... A/Z 0/9 1-4092  
..... A/Z 0/9 5001-9092

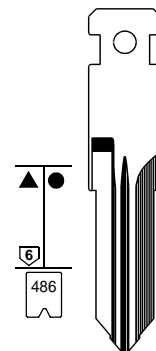

**VAC102-CI**  
..... A/Z 0/9 1-4092  
..... A/Z 0/9 5001-9092  
..... A/Z 0/9 1-4092  
..... A/Z 0/9 5001-9092

VALEO



NEIMAN - VACHETTE



VALEO



FOR:  
PER:

# RENAULT-DACIA

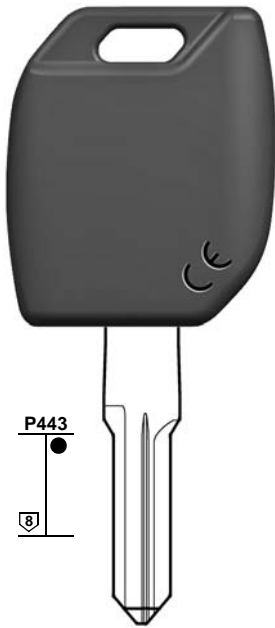

**MH KEY**  
**HU136MH**

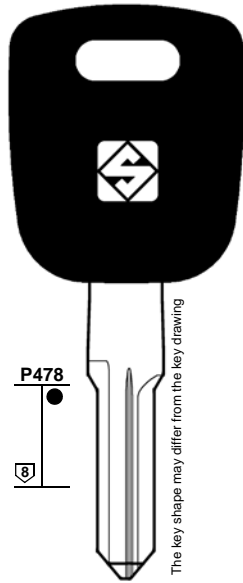

**TE KEY**  
**HU136TE**

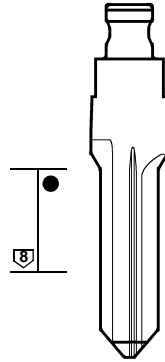

**FH FLIP**  
**HU136FH**

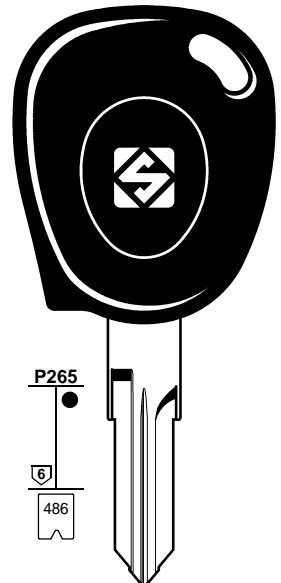

**VAC102T32**  
..... A/Z0/9 5001-9092  
..... 0/90/9 12345  
..... A/Z0/9 1-4092

FOR:  
PER:

# RENAULT-DACIA

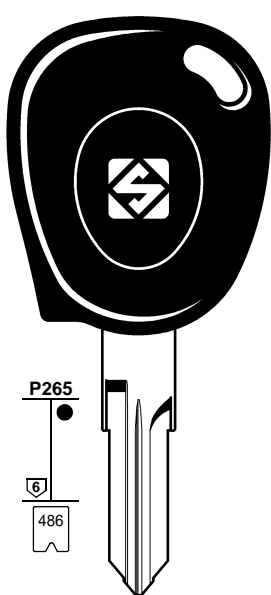

**TE KEY**  
**VAC102TE**  
..... A/Z 0/9 1-4092  
..... A/Z 0/9 5001-9092  
..... 0/90/9 12345

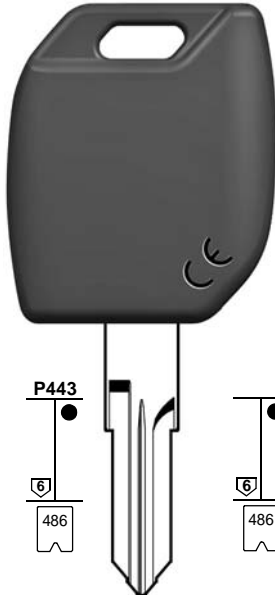

**MH KEY**  
**VAC102MH**  
..... A/Z 0/9 1-4092  
..... A/Z 0/9 5001-9092  
..... A/Z 0/9 1-2-3-4-5

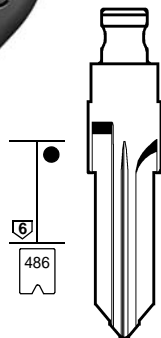

**FH FLIP**  
**VAC102FH**  
..... A/Z 0/9 1-4092  
..... A/Z 0/9 5001-9092

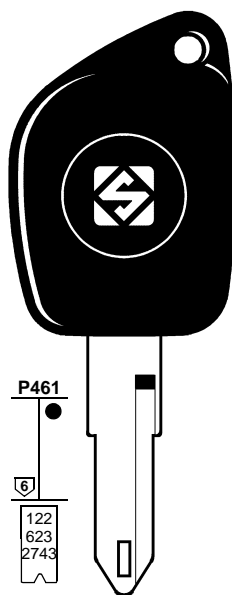

**TE KEY**  
**NE72ATE**  
..... 1/9 . . A/ZA/Z MNPRS  
..... 0/90/9 MNPRS  
..... 1/9 . . A/Z MNPRS  
..... 1/9 . . A/Z MNPRS  
..... 1/9 . . A/Z MNPRS  
..... 1/9 . . A/Z MNPRS  
..... 1/9 . . A/Z MNPRS  
..... 1/9 . . A/Z MNPRS  
..... 1/9 . . A/Z MNPRS



**MH KEY**  
**NE72MH**  
..... M-N-P-R-S  
..... 0/90/9 MNPRS  
..... 1/9 . . A/Z MNPRS  
..... 1/9 . . A/Z MNPRS  
..... 1/9 . . A/Z MNPRS  
..... 1/9 . . A/ZA/Z MNPRS  
..... 1/9 . . A/Z MNPRS  
..... 1/9 . . A/Z MNPRS  
..... 1/9 . . A/Z MNPRS  
..... 1/9 . . A/Z MNPRS

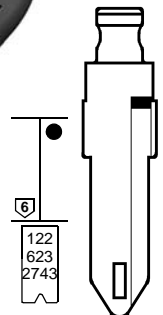

**FH FLIP**  
**NE72FH**  
..... 1/9 . . A/ZA/Z MNPRS  
..... 0/90/9 MNPRS  
..... 1/9 . . A/Z MNPRS  
..... 1/9 . . A/Z MNPRS  
..... 1/9 . . A/Z MNPRS  
..... 1/9 . . A/Z MNPRS  
..... 1/9 . . A/Z MNPRS  
..... 1/9 . . A/Z MNPRS  
..... 1/9 . . A/Z MNPRS

VALEO

VALEO

VALEO

VALEO





FOR:  
PER:

# ROLLS ROYCE

# ROVER

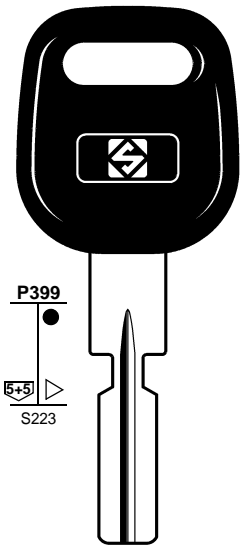
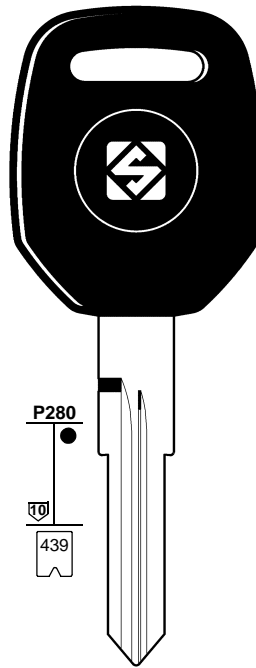
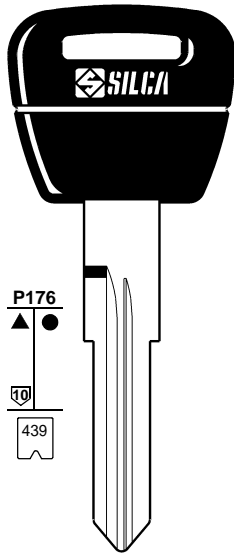
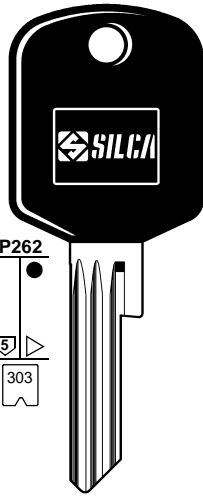
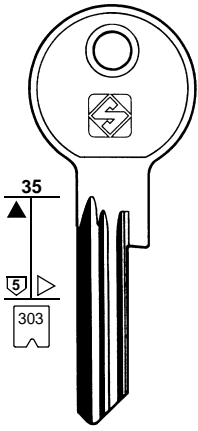

**RR2**  
BHL.... 501-597

**RR2P**  
BHL.... 501-597

**NE77RDP**  
R....  
6001-8000

**NE77RT2**  
R....  
6001-8000

**HU109FP**  
.... 1-6000

VALEO

FOR:  
PER:

# SAAB

# SATURN (GM)

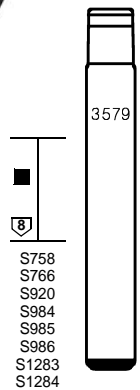
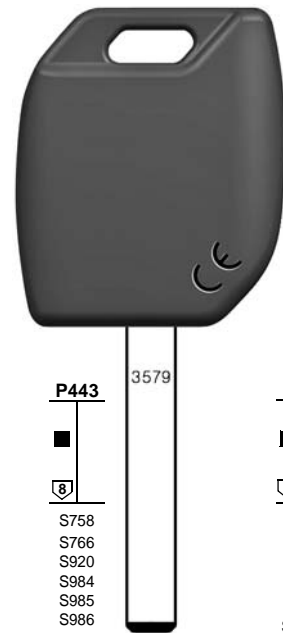
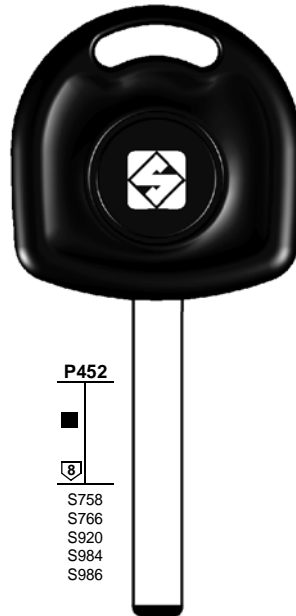
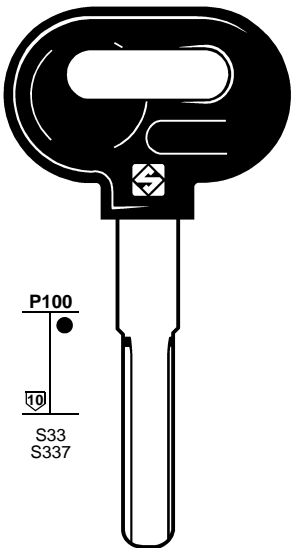

**YM30P**  
BC.... 0001-2865  
2S.... 0001-2675

**YM30T5**  
BC.... 0001-2865  
2S.... 0001-2675

**HU100TE**  
Z.... 1-2000  
Z.... 2001-4000  
Z.... 4001-6000

**HU100MH**  
Z.... 1-2000  
Z.... 2001-4000  
Z.... 4001-6000

**HU100FH**  
Z.... 1-2000  
Z.... 2001-4000  
Z.... 4001-6000  
.... 0001-3679

HUF - VALEO

HUF - VALEO



FOR:  
PER:

# SATURN (GM)

**P340**  
567  
2020  
Master

**P339**  
2020

**P310**  
110

**P443**  
110

**B97-PT**  
..... 1-1988  
H ..... 1-3988  
O ..... 5000-6999  
..... S000A-S711K

**B111-PT**  
G ..... 0-3631

**DW05TE** (TE KEY)  
T ..... 1-1200

**DW05MH** (MH KEY)  
T ..... 1-1200

**DW05FH** (FH FLIP)  
T ..... 1-1200  
L ..... 1-1200  
V ..... 1-1200  
V ..... 2001-3200

BRIGGS & STRATTON

FOR:  
PER:

# SCION

**938**  
8/10

**P305**  
8/10  
514  
1420  
2751

**P443**  
8/10  
514  
1420  
1552  
2751  
2756  
S232

**8/10**  
514  
1420  
2751  
2756

**TOY43**

**TOY43AT31**  
..... 10001-15000  
..... 50000-59999  
..... 60000-69999

**TOY43ATE** (TE KEY)  
..... 10001-15000  
..... 50000-59999  
..... 60000-69999

**TOY43MH** (MH KEY)  
..... 10001-15000  
..... 50000-59999  
..... 60000-69999  
..... 25001-26200  
..... 1-5000

**TOY43FH** (FH FLIP)  
..... 10001-15000  
..... 50000-59999  
..... 60000-69999  
..... 25001-26200



FOR:  
PER:

# SEAT



P254



S102  
S260  
S482  
S832

1ATS ..... 00001-17850  
..... 1-2000  
..... 1-6000

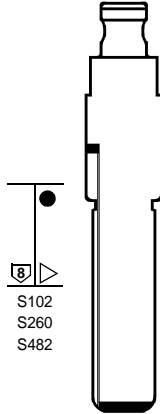
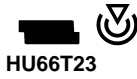

S102  
S260  
S482



P254



49  
50

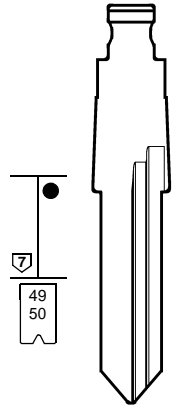
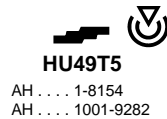

49  
50

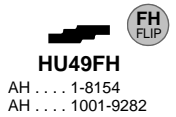

FOR:  
PER:

# SKODA



P275



S102  
S482

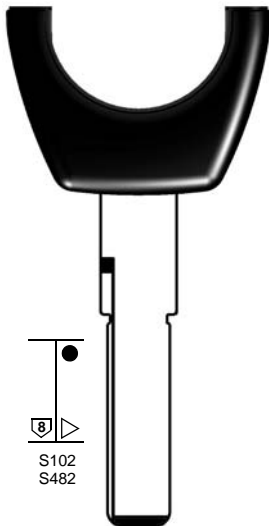

P254



S102  
S482

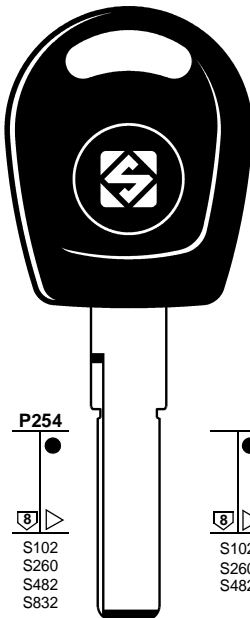

P254



S102  
S260  
S482  
S832

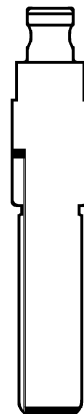
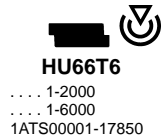

S102  
S260  
S482

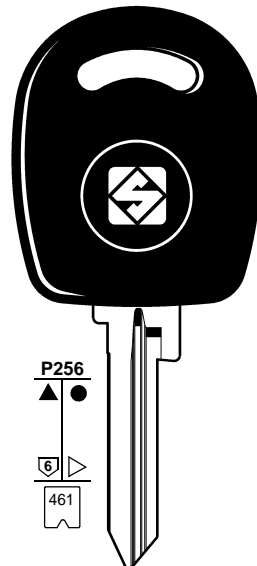
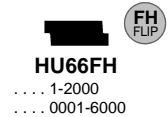

P256



461

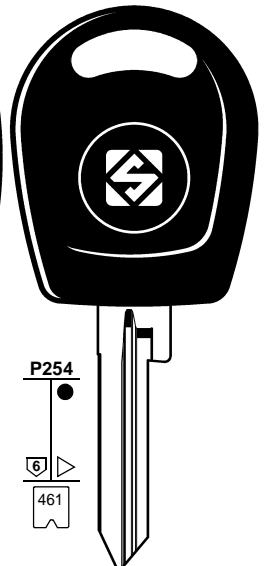

P254



461



1	2	2a	3	3a	3b	e1+e2		6	42+71	72	43+44a	12	15
						GTI COMPATIBLE		IGNITION					
CAR MAKE MODEL	FROM	TO	SILCA REF.	SILCA REF.	SILCA REF.	COPY	GEN.	TRANSP. TYPE	FAST COPY PLUS RW4 PLUS FAST COPY/RW4	FAST COPY PLUS RW4 PLUS	FAST COPY RW4	STP	
For more info on the uses of car keys, refer to the Silca Electronic Keys Catalogue:													
<b>SEAT</b>													
ALHAMBRA	1996	1998	HU66T5		HU66FH			PH	33	Y	Y	S-V	
ALHAMBRA	1998	2000	HU66T10		HU66FH			PH / CR	42	Y	Y		
ALHAMBRA	2000	2005	HU66T28		HU66FH			PH / CR	4W	RD	RD		
ALHAMBRA	2006	2010	HU66T6		HU66FH			MEG / CR	48				
ALHAMBRA	2010							MEG / CR	A3				
ALTEA	2004	2005	HU66T6		HU66FH			MEG / CR	48				
ALTEA	2004	2008	HU66T23		HU66FH			MEG / CR	A3				
ALTEA	2008							MEG / CR	A3				
ALTEA XL	2006	2008	HU66T23		HU66FH			MEG / CR	A3				
ALTEA XL	2008							MEG / CR	A3				
AROSA	1997	1999	HU66T5		HU66FH			PH	33	Y	Y	S-V	
AROSA	1999	2001	HU66T10		HU66FH			PH / CR	42	Y	Y		
AROSA	2001	2005	HU66T28		HU66FH			PH / CR	4W	RD	RD		
CORDOBA	1995	1998	HU49T5		HU49FH			PH	33	Y	Y	S-V	
CORDOBA	1999	2002	HU66T10		HU66FH			PH / CR	42	Y	Y		
CORDOBA	2002	2009	HU66T6		HU66FH			MEG / CR	48				
EXEO	2008							MEG / CR	A3				
FREETRACK	2008							MEG / CR	A3				
IBIZA	1995	1998	HU49T5		HU49FH			PH	33	Y	Y	S-V	
IBIZA	1998	2002	HU66T10		HU66FH			PH / CR	42	Y	Y		
IBIZA	2002	2009	HU66T6		HU66FH			MEG / CR	48				
IBIZA	2008							MEG / CR	A3				
INCA	1996	1998	HU49T5		HU49FH			PH	33	Y	Y	S-V	
INCA	1998	2000	HU66T10		HU66FH			PH / CR	42	Y	Y		
INCA	2000	2003	HU66T28		HU66FH			PH / CR	4W	RD	RD		
LEON	2000	2005	HU66T6		HU66FH			MEG / CR	48				
LEON	2005	2008	HU66T23		HU66FH			MEG / CR	A3				
LEON	2008							MEG / CR	A3				
MARBELLA	1997	1998	HU49T5		HU49FH			TEMIC	11	Y	Y	T-F	
MII	2012							MEG / CR	A3				
TOLEDO	1995	1999	HU49T5		HU49FH			PH	33	Y	Y	S-V	
TOLEDO	1997	1999	HU66T5		HU66FH			MEG	13	Y	Y		
TOLEDO	2000	2004	HU66T6		HU66FH			MEG / CR	48				
TOLEDO	2005	2008	HU66T23		HU66FH			MEG / CR	A3				
<b>SKODA</b>													
CITIGO	2012							MEG / CR	A4				
FABIA	2000	2006	HU66AT6		HU66FH			MEG / CR	48				
FABIA	2007							MEG / CR	A4				
FELICIA	1995	1996	SK22RBP										
FELICIA	1996	1998	SK22RT1					PH	33	Y	Y	S-V	
FELICIA	1998	2001	HU66AT5		HU66FH			PH	33	Y	Y	S-V	
FELICIA	1998	2001	HU66CT5		HU66FH			PH	33	Y	Y	S-V	
FELICIA	1999	2001	HU66AT6		HU66FH			MEG / CR	48				
OCTAVIA	1997	2001	HU66AT5		HU66FH			MEG	13	Y	Y	Meg	
OCTAVIA	1997	2001	HU66CT5		HU66FH			MEG	13	Y	Y	Meg	
OCTAVIA	2001	2004	HU66T6		HU66FH			MEG / CR	48				

FOR:  
PER:

# SKODA

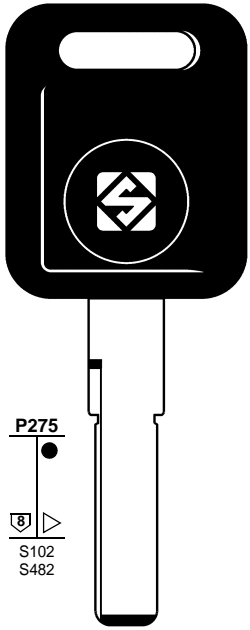

P275  
S102  
S482



**HU66AT5**  
..... 1-2000  
1ATS00001-17850

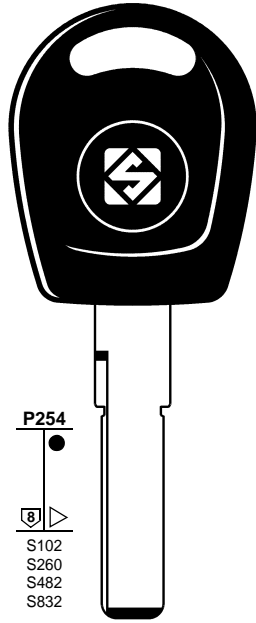

P254  
S102  
S260  
S482  
S832



**HU66T6**  
..... 1-2000  
..... 1-6000  
1ATS00001-17850



**HU66T26**  
1ATS00001-17850

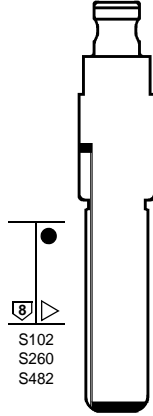

P254  
S102  
S260  
S482



**HU66FH**  
..... 1-2000  
..... 0001-6000

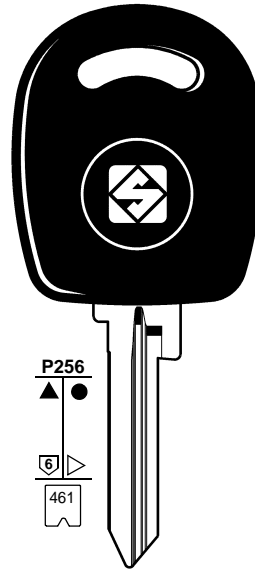

P256  
461



**SK22RBP**  
4AE ..... 1-2780  
4AT ..... 1-2780

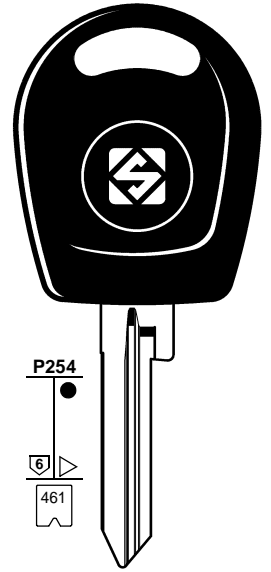

P254  
461



**SK22RT1**  
4AE ..... 1-2780  
4AT ..... 1-2780

FOR:  
PER:

# SMART

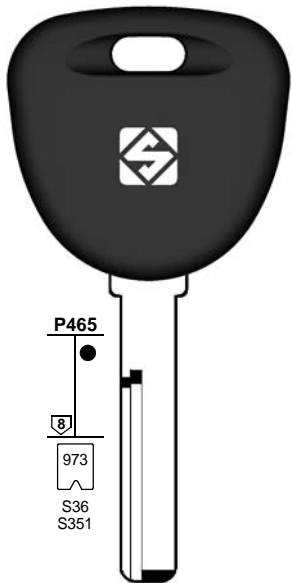

P465  
973  
S36  
S351



**HU56RTE**  
DH .....  
1-4000  
6001-8000

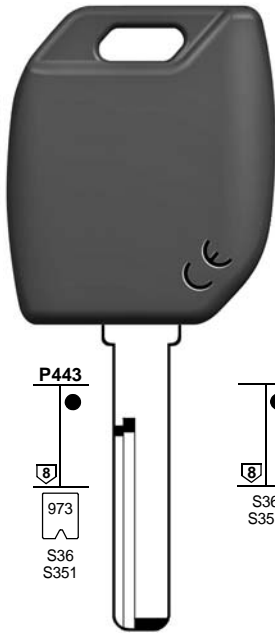

P443  
973  
S36  
S351



**HU56RMH**  
DH .....  
1-4000  
6001-8000

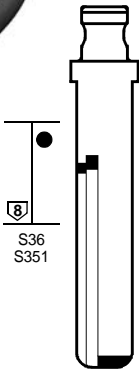

P443  
S36  
S351



**HU56RFH**  
DH .....  
1-4000  
6001-8000



P454  
S681  
S823  
S830  
S1336



**VA2TE**  
..... 1-2-3-4-Q-5-6-7-8-H  
..... A-B-C-D-E-F

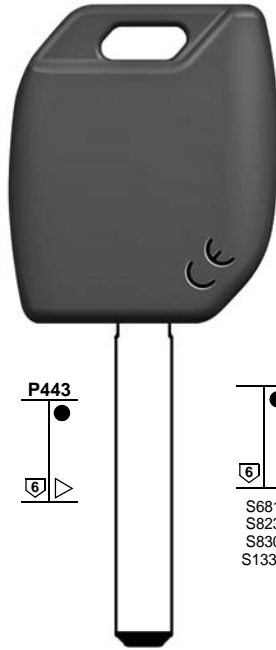

P443  
S681  
S823  
S830  
S1336



**VA2MH**

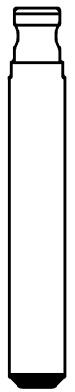

P443  
S681  
S823  
S830  
S1336



**VA2FH**  
..... 1-2-3-4-Q-5-6-7-8-H  
..... A-B-C-D-E-F





FOR:  
PER:

# SSANGYONG

**SSY1P**  
..... 2001-3000

**SSY2AP**  
H..... 1001-2000  
S..... 1-2000

**SSY3**  
K..... 0001-1000

**SSY3TE**  
SK..... 1-1000  
KH..... 1-1000

**SSY3MH**  
SK..... 1-1000  
KH..... 1-1000

**SSY3FH**  
K..... 1-1000

FOR:  
PER:

# SSANGYONG

# SUBARU

**HYN10BP**  
R..... 1-1000  
K..... 1-1000

**NSN19T21**  
..... 30001-37850

**NSN19TE**  
..... 1-22185  
..... 30001-37850

**NSN19MH**  
..... 1-22185  
..... 30001-37850



FOR:  
PER:

# SUBARU

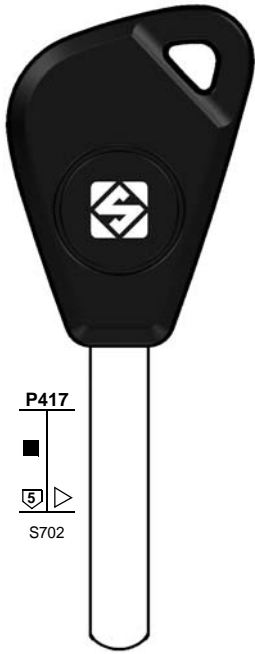

P417  
■  
5  
S702

**DAT17T21**  
T.... 1-3000

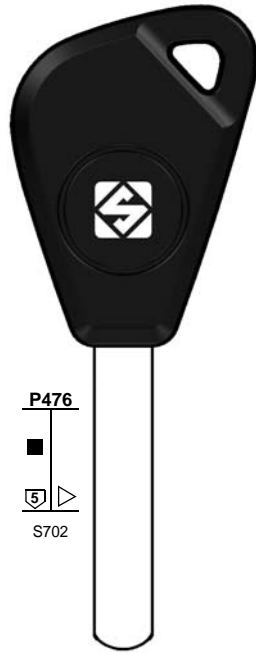

P476  
■  
5  
S702

**DAT17TE**  
T.... 1-3000

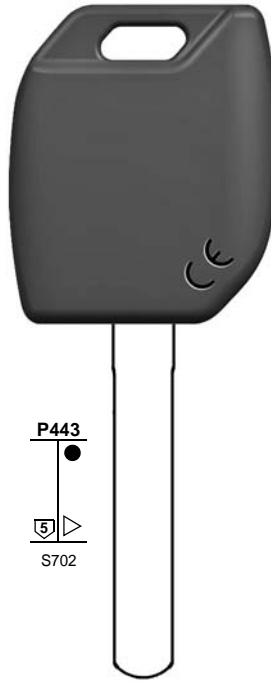

P443  
●  
5  
S702

**DAT17MH**  
T.... 1-3000

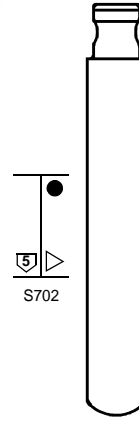

●  
5  
S702

**DAT17FH**  
T.... 1-3000

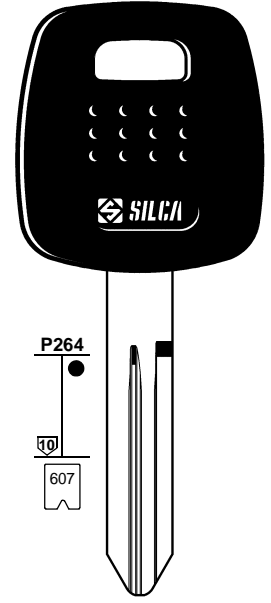

P264  
●  
10  
607

**NSN14T13**  
..... 1-22185

**NSN14TE**  
..... 1-22185  
..... 30001-37850

FOR:  
PER:

# SUBARU

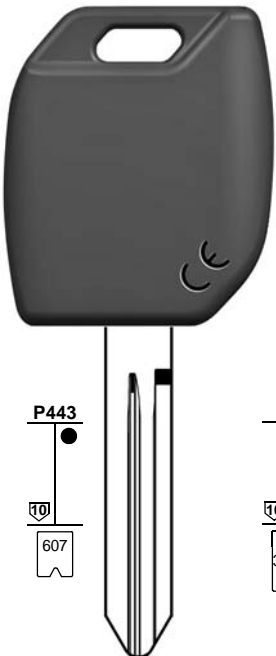

P443  
●  
10  
607

**NSN14MH**  
..... 1-22185  
..... 30001-37850

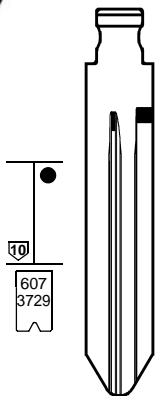

●  
10  
607  
3729

**NSN14FH**  
..... 1-22185

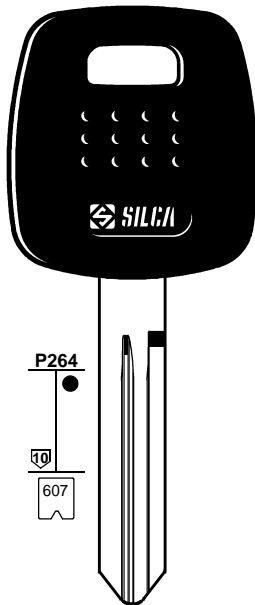

P264  
●  
10  
607

**NSN19TE**  
..... 1-22185  
..... 30001-37850



P443  
●  
10  
607

**NSN19MH**  
..... 1-22185  
..... 30001-37850

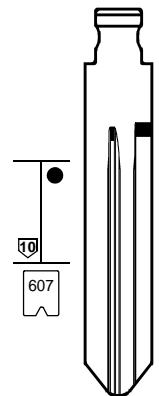

●  
10  
607

**NSN19FH**  
..... 1-22185  
..... 30001-37850

VALEO

VALEO



FOR:  
PER:

# SUBARU

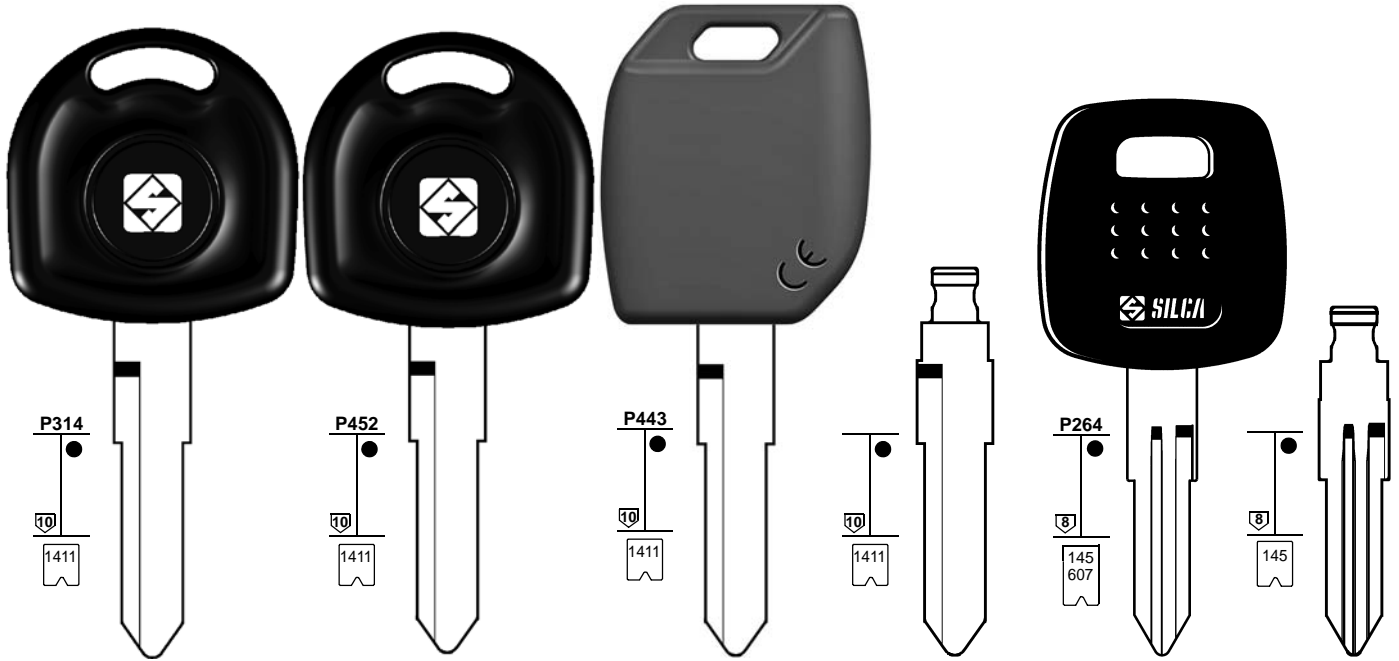

  
**HU87RT18**  
.....  
50001-51308

  
**HU87RTE**  
.....  
50001-51308

  
**HU87RMH**  
.....  
50001-51308

  
**HU87RFH**  
.....  
50001-51308

  
**NSN11T2**  
X ..... 1-8000  
..... 1-22185  
..... 30001-37850  
X ..... 8001-9000

  
**NSN11FH**  
X ..... 1-8000  
X ..... 8001-9000

FOR:  
PER:

# SUBARU

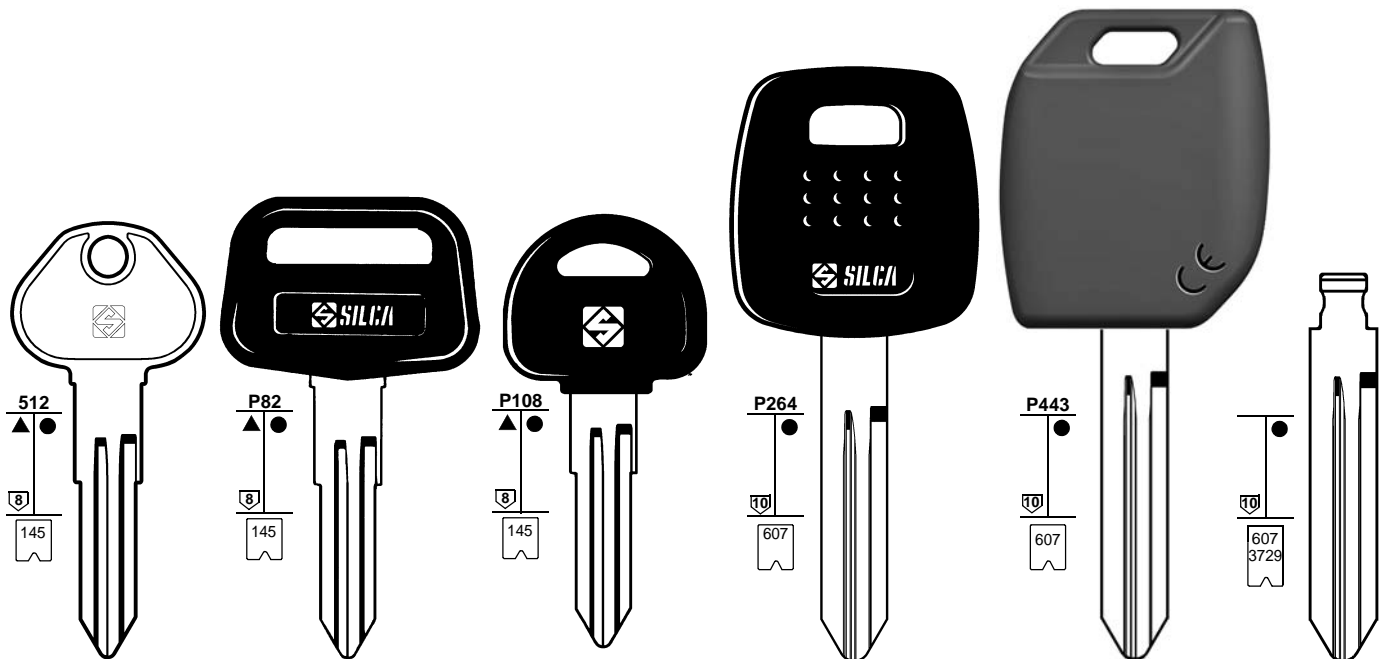

  
**DAT12**  
X ..... 1-8000  
X ..... 8001-9000

  
**DAT12BP**  
X ..... 1-8000  
X ..... 8001-9000

  
**DAT12CP**  
X ..... 1-8000  
X ..... 8001-9000

  
**NSN14T13**  
..... 1-22185

  
**NSN14MH**  
..... 1-22185  
..... 30001-37850

  
**NSN14FH**  
..... 1-22185

  
**NSN14TE**  
..... 1-22185  
..... 30001-37850



FOR:  
PER:

# SUBARU

**P264**  
607

**P443**  
607

**P417**  
S702

**P476**  
S702

**NSN19T21**  
..... 30001-37850

**NSN19T13**  
..... 30001-37850

**NSN19MH**  
..... 1-22185  
..... 30001-37850

**NSN19FH**  
..... 1-22185  
..... 30001-37850

**DAT17T21**  
T ..... 1-3000

**DAT17TE**  
T ..... 1-3000

**NSN19TE**  
..... 1-22185  
..... 30001-37850

VALEO

FOR:  
PER:

# SUBARU

**P443**  
S702

**P295**  
264

**P443**  
264

**P264**  
145 607

**DAT17MH**  
T ..... 1-3000

**DAT17FH**  
T ..... 1-3000

**SZ12TE**  
U ..... 1-2000

**SZ12MH**  
U ..... 1-2000

**SZ12FH**  
U ..... 1-2000

**NSN11T2**  
X ..... 1-8000  
..... 1-22185  
..... 30001-37850  
X ..... 8001-9000

**NSN11FH**  
X ..... 1-8000  
X ..... 8001-9000

**SZ12T4**  
U ..... 1-2000

VALEO





FOR:  
PER:

# SUBARU

**NSN14T13**  
..... 1-22185

**NSN14MH**  
..... 1-22185  
..... 30001-37850

**NSN14FH**  
..... 1-22185

**DAT17T21**  
T ..... 1-3000

**DAT17TE**  
T ..... 1-3000

**DAT17MH**  
T ..... 1-3000

**NSN14TE**  
..... 1-22185  
..... 30001-37850

**DAT17T13**  
T ..... 1-3000

FOR:  
PER:

# SUBARU

**DAT17FH**  
T ..... 1-3000

**NSN19T13**  
..... 30001-37850

**NSN19MH**  
..... 1-22185  
..... 30001-37850

**NSN19FH**  
..... 1-22185  
..... 30001-37850

**NSN11T2**  
X ..... 1-8000  
..... 1-22185  
..... 30001-37850  
X ..... 8001-9000

**NSN11FH**  
X ..... 1-8000  
X ..... 8001-9000

**NSN19TE**  
..... 1-22185  
..... 30001-37850

VALEO

VALEO

VALEO



FOR:  
PER:

# SUBARU

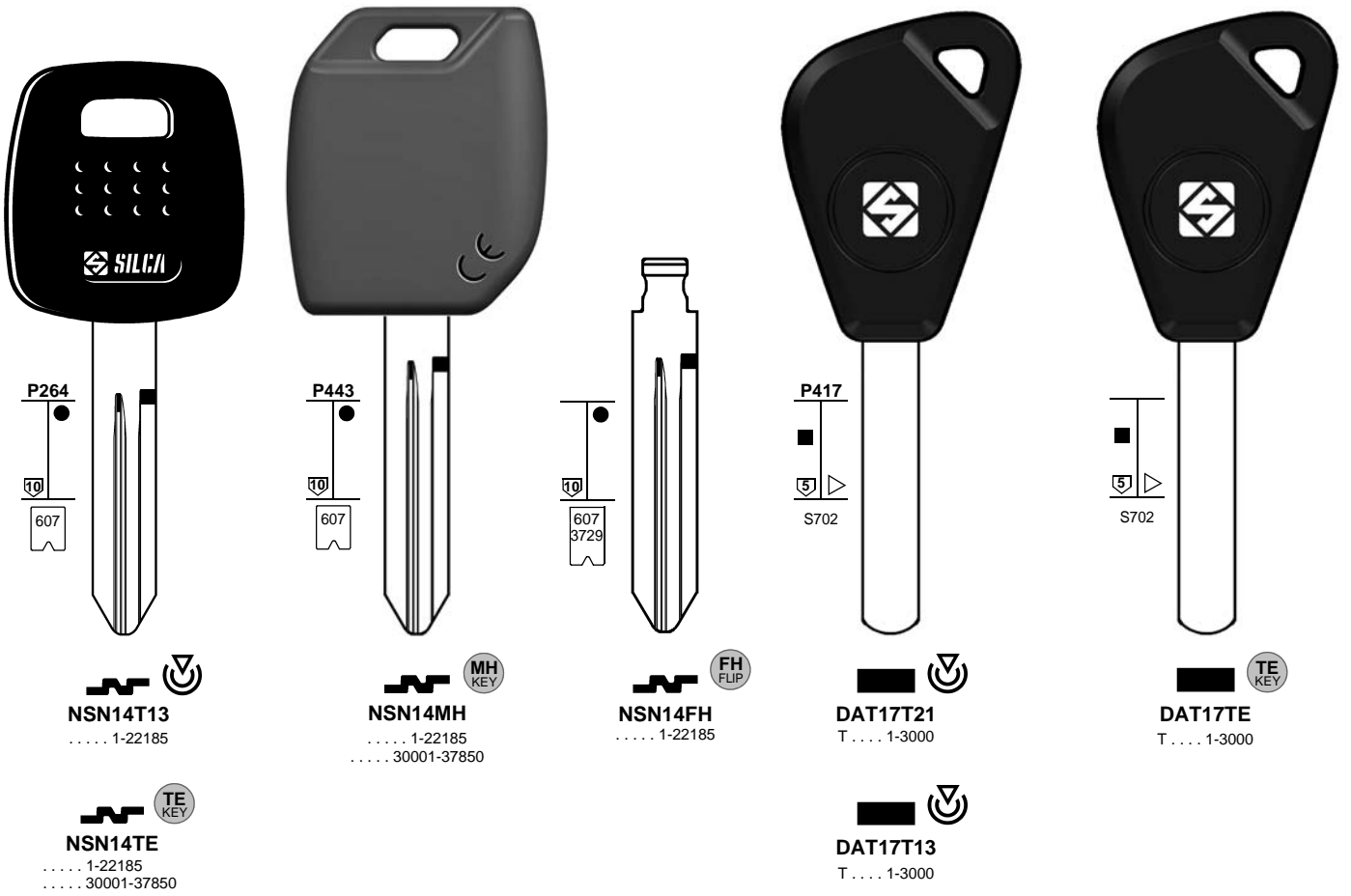

FOR:  
PER:

# SUBARU

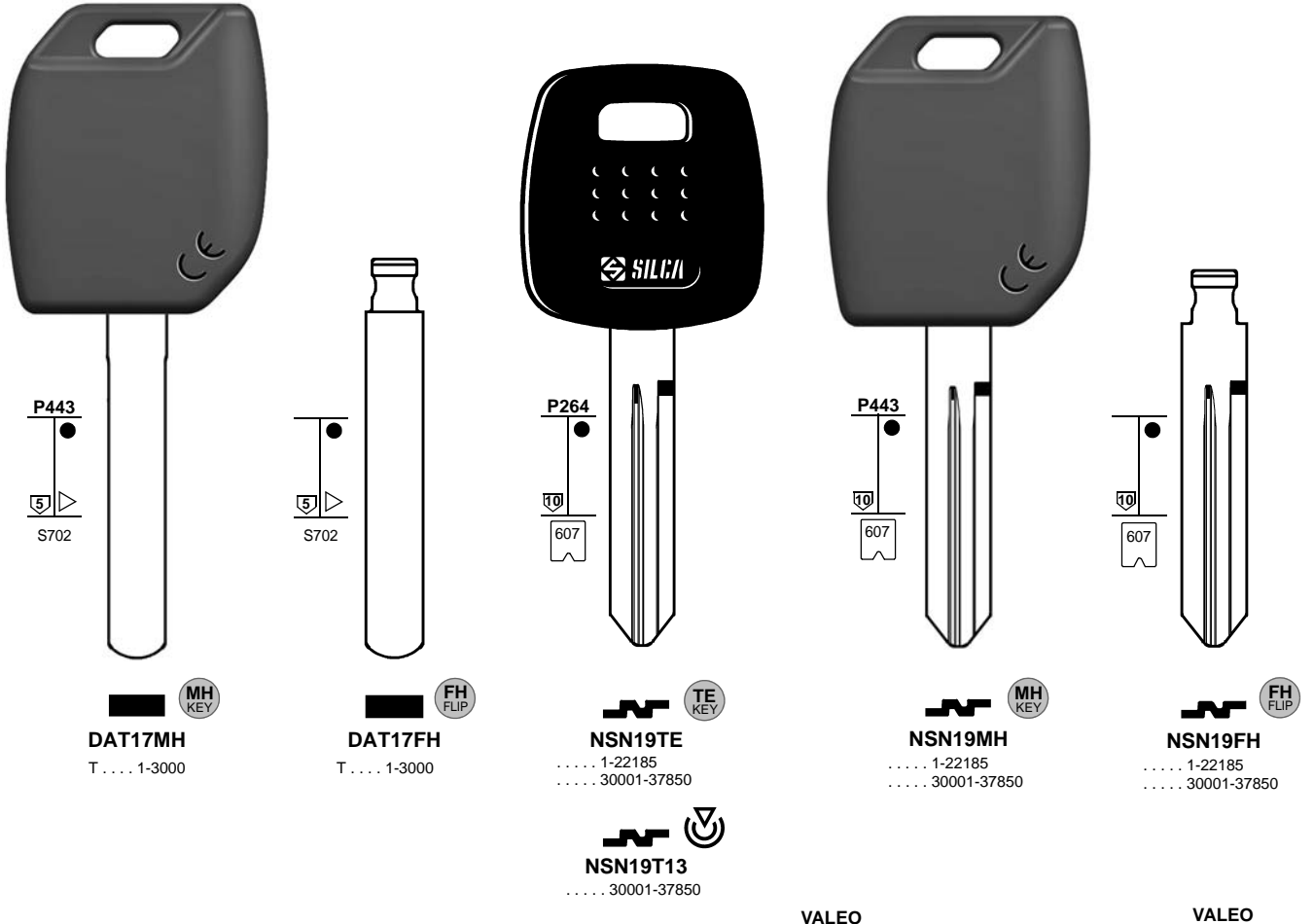



FOR:  
PER:

### SUBARU

### SUZUKI

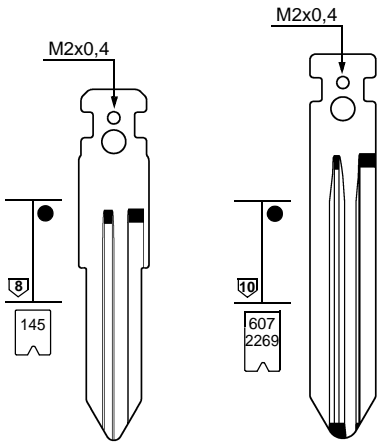

**NSN11T**  
X . . . . 1-8000  
X . . . . 8001-9000

VALEO

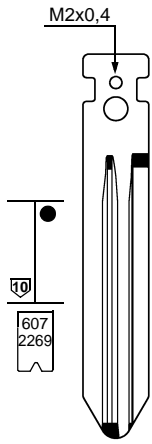

**NSN14T**  
. . . . . 1-22185

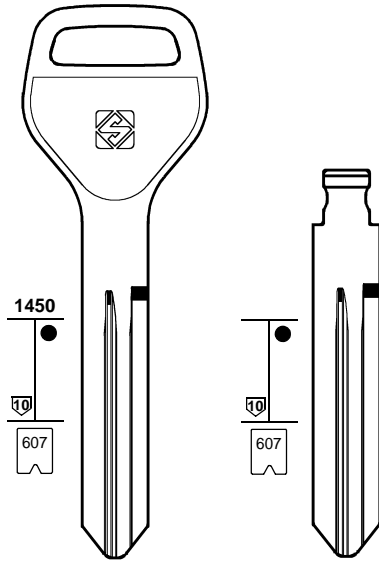

**NSN19**  
. . . . . 30001-37850

VALEO

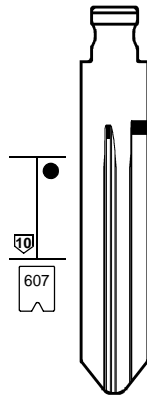

**NSN19FH**  
. . . . . 1-22185  
. . . . . 30001-37850

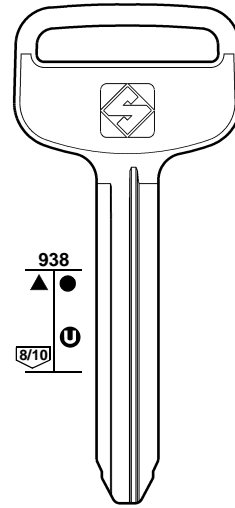

**TOY43**

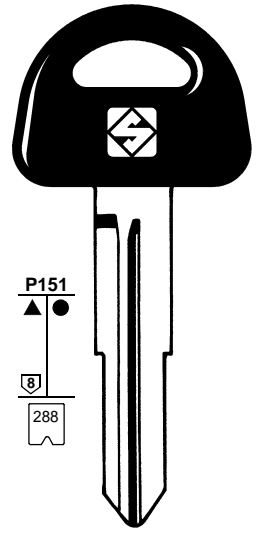

**SZ11RP**  
. . . . . 18100-19299

FOR:  
PER:

### SUZUKI

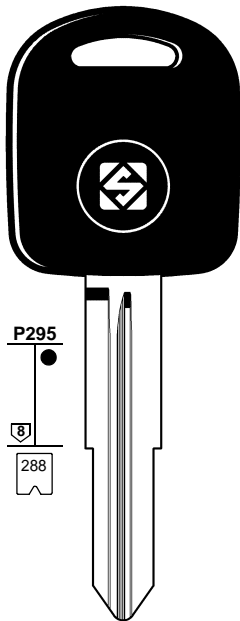

**SZ11RT4**  
. . . . . 18100-19299  
. . . . . 19300-19617

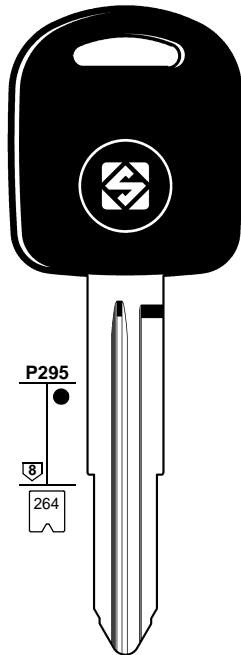

**SZ12TE**  
U . . . . 1-2000

**SZ12T4**  
U . . . . 1-2000



**SZ12MH**  
U . . . . 1-2000

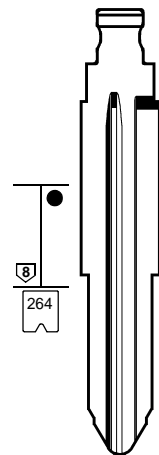

**SZ12FH**  
U . . . . 1-2000



FOR:  
PER:

# SUZUKI

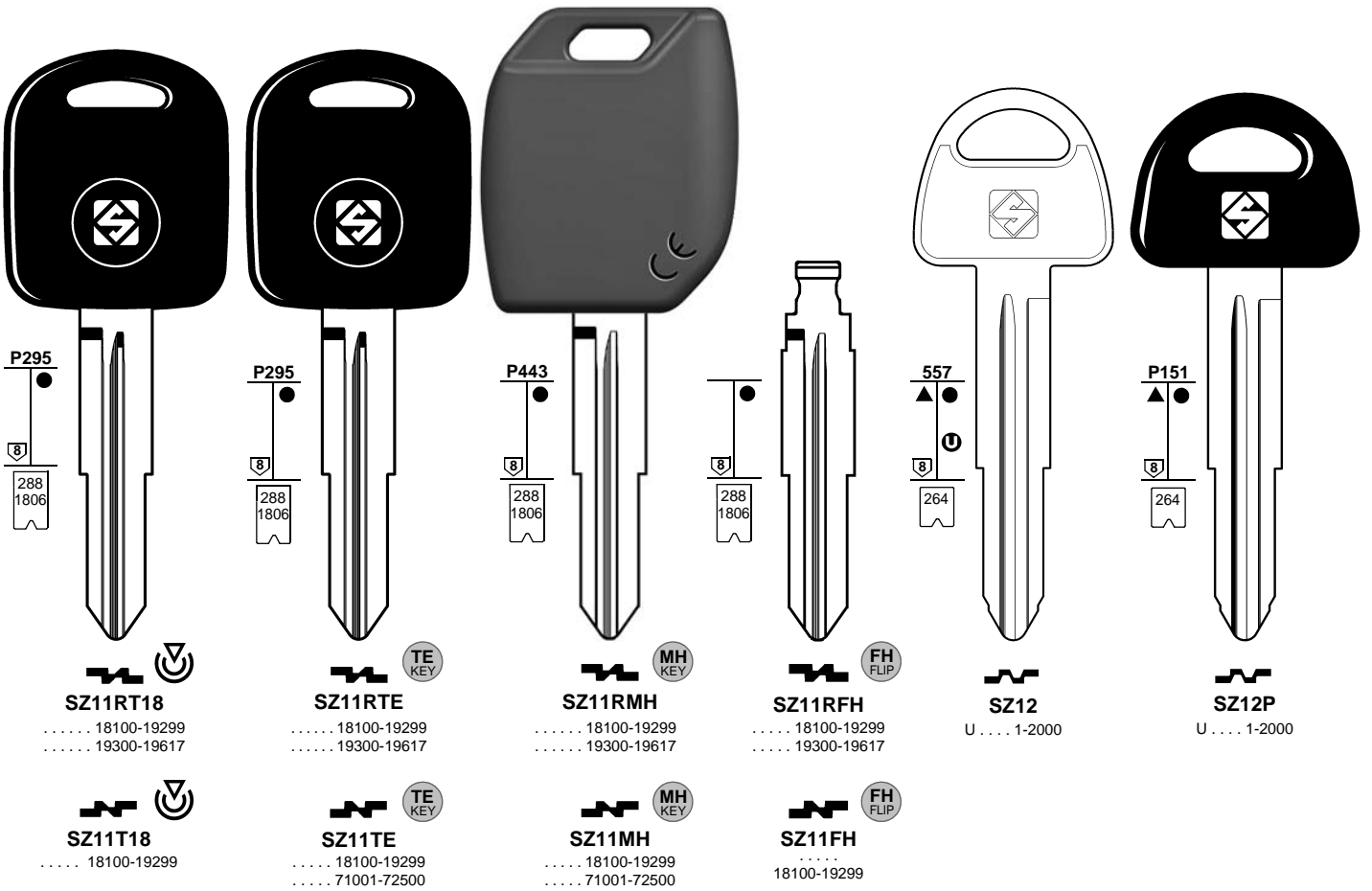

FOR:  
PER:

# SUZUKI

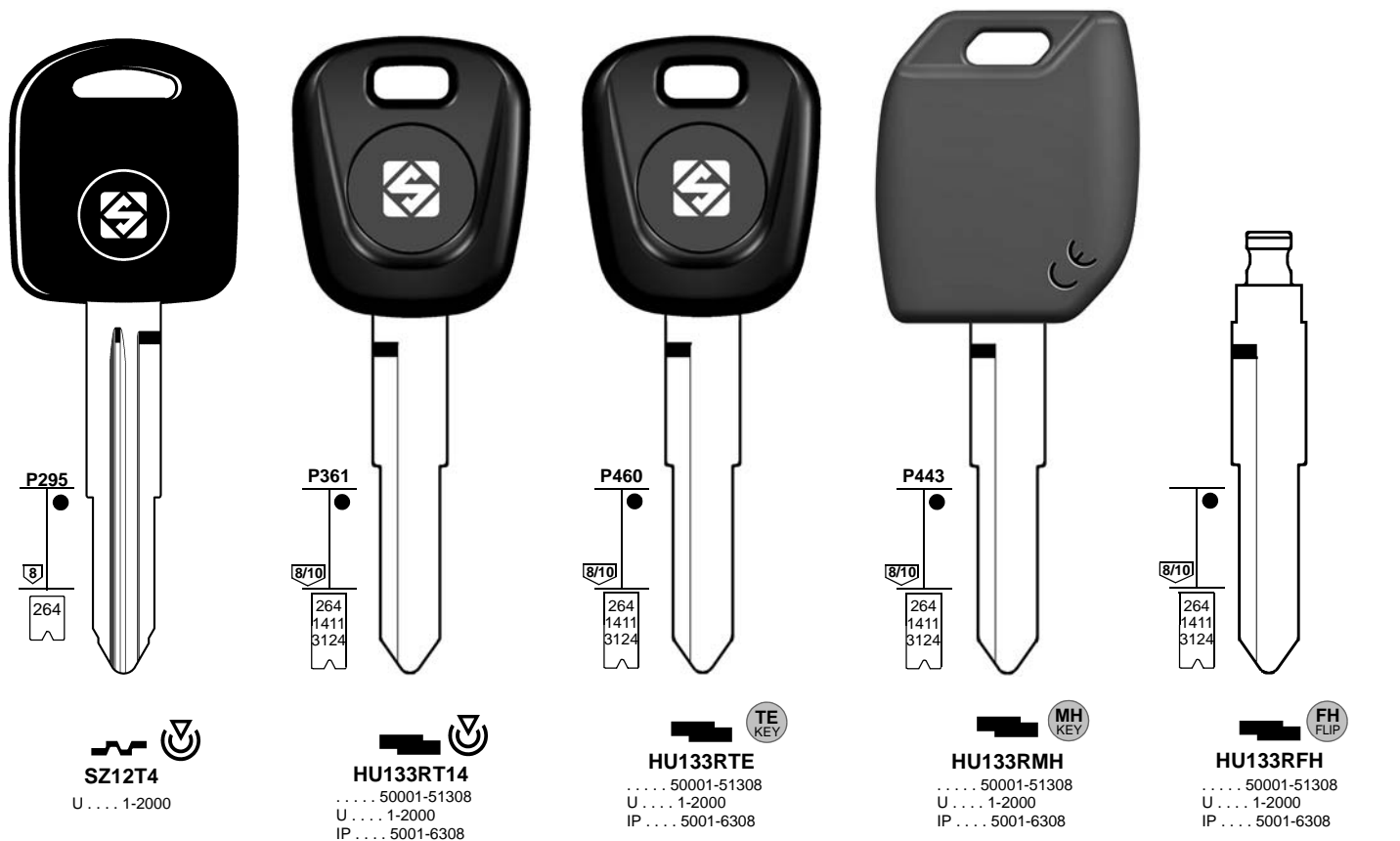

HUF

HUF





FOR:  
PER:

# SUZUKI



**SZ11RT4**  
..... 18100-19299  
..... 19300-19617

**SZ11RTE**  
..... 18100-19299  
..... 19300-19617



**SZ11RMH**  
..... 18100-19299  
..... 19300-19617

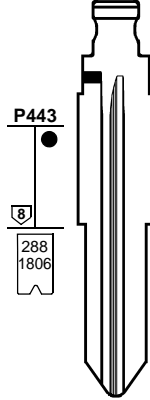

**SZ11RFH**  
..... 18100-19299  
..... 19300-19617



**SZ12T4**  
U ..... 1-2000

**SZ12TE**  
U ..... 1-2000

FOR:  
PER:

# SUZUKI

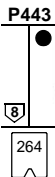

**SZ12MH**  
U ..... 1-2000

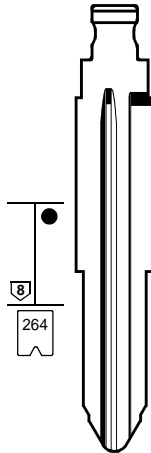

**SZ12FH**  
U ..... 1-2000



**NSN14T14**  
..... 1-22185

**NSN14TE**  
..... 1-22185  
..... 30001-37850



**NSN14MH**  
..... 1-22185  
..... 30001-37850

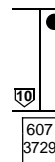
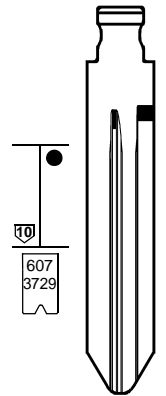

**NSN14FH**  
..... 1-22185



FOR:  
PER:

# SUZUKI

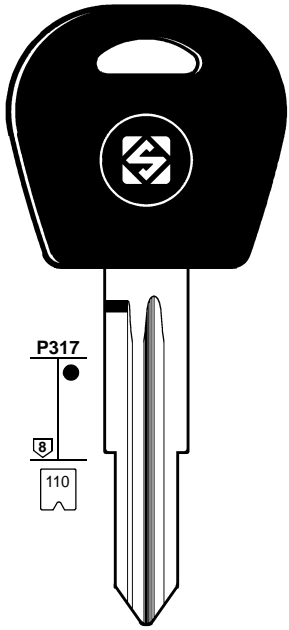

P317  
8  
110

**DWO4RAP**  
J ..... 1-1200  
M ..... 1-1200

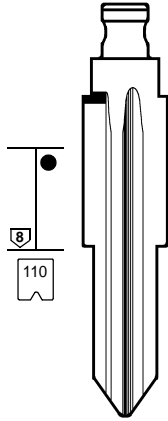

8  
110

**DWO4RFH**  
J ..... 1-1200  
T ..... 1-1200  
M ..... 1-1200

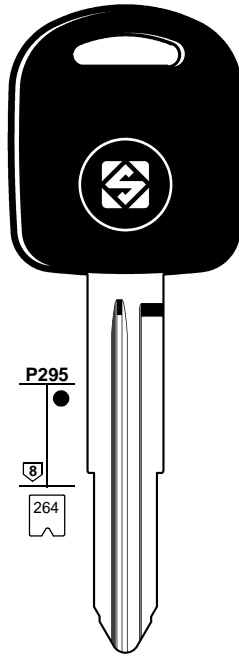

P295  
8  
264

**SZ12T4**  
U ..... 1-2000

**SZ12TE**  
U ..... 1-2000



P443  
8  
264

**SZ12MH**  
U ..... 1-2000

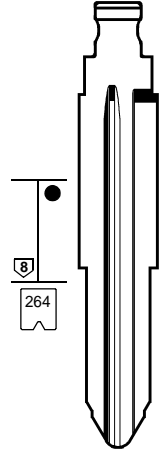

8  
264

**SZ12FH**  
U ..... 1-2000

FOR:  
PER:

# SUZUKI

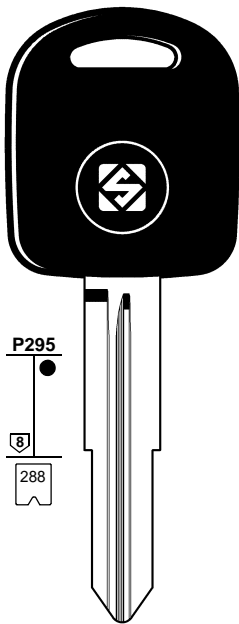

P295  
8  
288

**SZ11RT4**  
..... 18100-19299  
..... 19300-19617

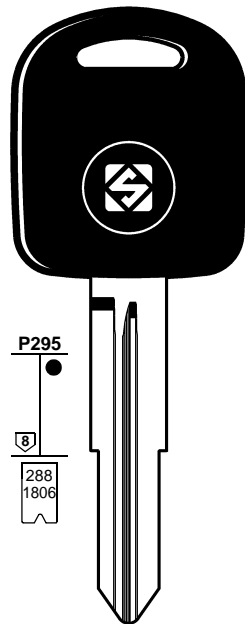

P295  
8  
288  
1806

**SZ11RTE**  
..... 18100-19299  
..... 19300-19617

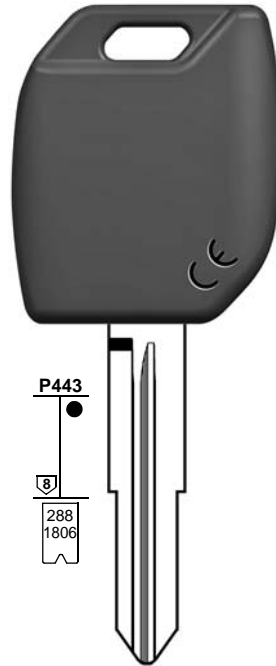

P443  
8  
288  
1806

**SZ11RMH**  
..... 18100-19299  
..... 19300-19617

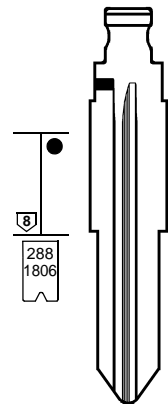

8  
288  
1806

**SZ11RFH**  
..... 18100-19299  
..... 19300-19617



FOR:  
PER:

# SUZUKI

**SZ11RT18**  
..... 18100-19299  
..... 19300-19617

**SZ22TE**  
..... 25001-26200

**SZ22MH**  
..... 25001-26200

**SZ22FH**  
..... 25001-26200

**HU133RTE**  
..... 50001-51308  
U ..... 1-2000  
IP ..... 5001-6308

HUF

FOR:  
PER:

# SUZUKI

**HU133RMH**  
..... 50001-51308  
U ..... 1-2000  
IP ..... 5001-6308

**HU133RFH**  
..... 50001-51308  
U ..... 1-2000  
IP ..... 5001-6308

**HU87RT18**  
..... 50001-51308

**HU87RTE**  
..... 50001-51308

**HU87RMH**  
..... 50001-51308

**HU87RFH**  
..... 50001-51308

**HU87RT9**  
..... 50001-51308

HUF



FOR:  
PER:

# SUZUKI

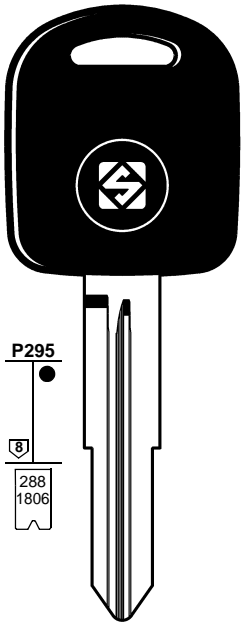

P295  
8  
288  
1806



**SZ11RTE**

..... 18100-19299  
..... 19300-19617

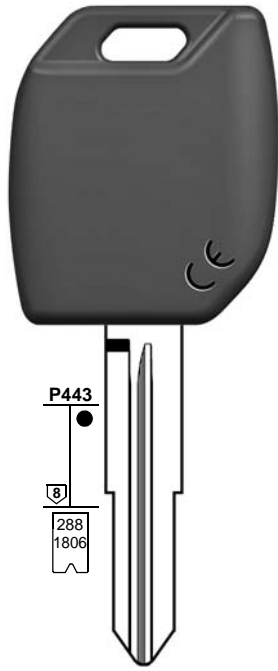

P443  
8  
288  
1806



**SZ11RMH**

..... 18100-19299  
..... 19300-19617

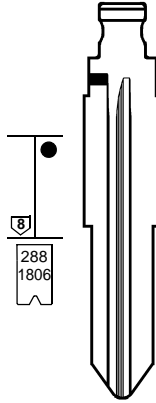

P314  
8  
288  
1806



**SZ11RFH**

..... 18100-19299  
..... 19300-19617

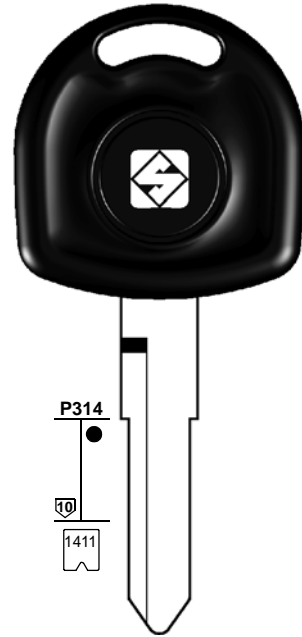

P314  
10  
1411



**HU87RT5**

..... 50001-51308

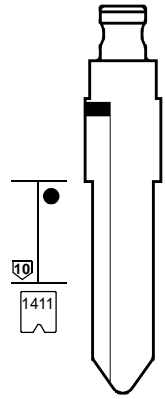

P314  
10  
1411



**HU87RFH**

..... 50001-51308



**SZ11RT4**

..... 18100-19299  
..... 19300-19617



**SZ11RT5**

..... 18100-19299  
..... 19300-19617

FOR:  
PER:

# SUZUKI

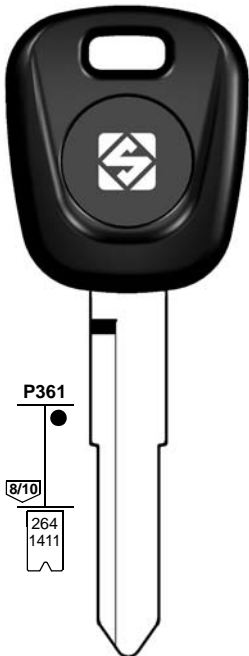

P361  
8/10  
264  
1411



**HU133RT18**

..... 50001-51308  
U..... 1-2000

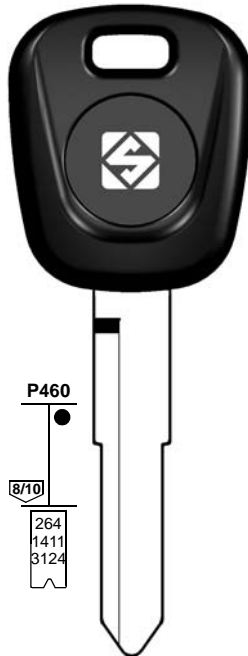

P460  
8/10  
264  
1411  
3124



**HU133RTE**

..... 50001-51308  
U..... 1-2000  
IP..... 5001-6308

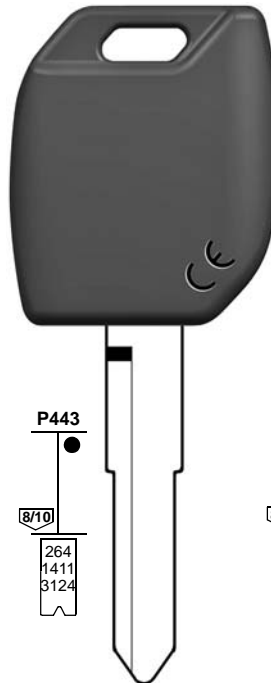

P443  
8/10  
264  
1411  
3124



**HU133RMH**

..... 50001-51308  
U..... 1-2000  
IP..... 5001-6308

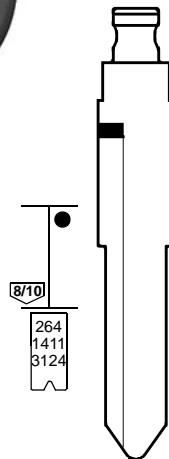

P305  
8/10  
264  
1411  
3124



**HU133RFH**

..... 50001-51308  
U..... 1-2000  
IP..... 5001-6308

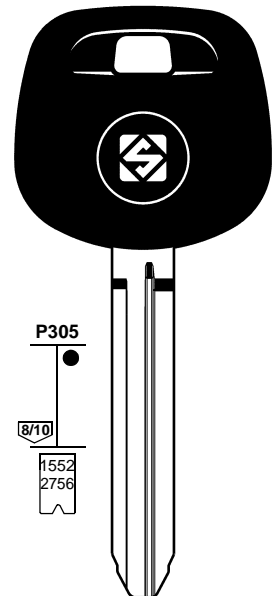

P305  
8/10  
1552  
2756



**TOY43AT18**

..... 25001-26200

HUF

HUF





FOR:  
PER:

# SUZUKI

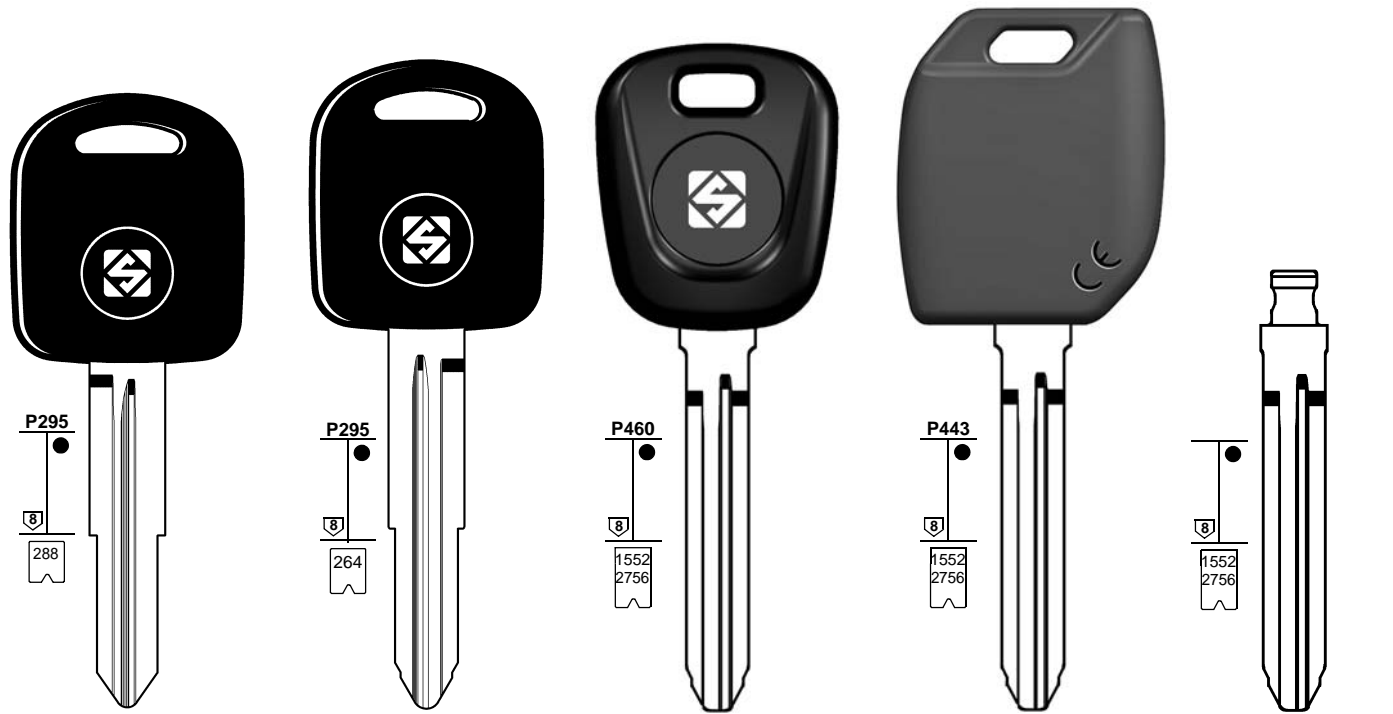

**SZ11RT4**  
..... 18100-19299  
..... 19300-19617

**SZ12T4**  
U ..... 1-2000

**SZ22TE**  
..... 25001-26200

**SZ22MH**  
..... 25001-26200

**SZ22FH**  
..... 25001-26200

FOR:  
PER:

# SUZUKI

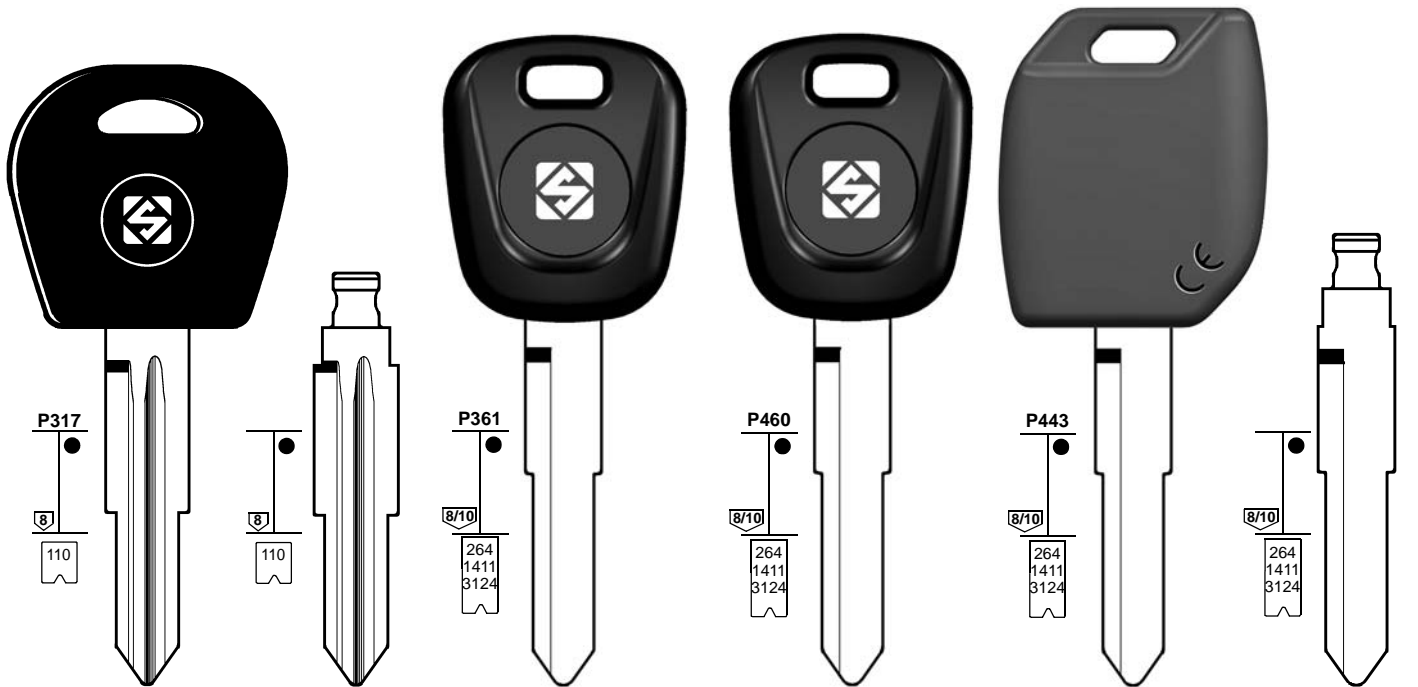

**DWO4RAP**  
J ..... 1-1200  
M ..... 1-1200

**DWO4RFH**  
J ..... 1-1200  
T ..... 1-1200  
M ..... 1-1200

**HU133RT12**  
..... 50001-51308

**HU133RT14**  
..... 50001-51308  
U ..... 1-2000  
IP ..... 5001-6308

**HU133RTE**  
..... 50001-51308  
U ..... 1-2000  
IP ..... 5001-6308

**HU133RMH**  
..... 50001-51308  
U ..... 1-2000  
IP ..... 5001-6308

**HU133RFH**  
..... 50001-51308  
U ..... 1-2000  
IP ..... 5001-6308

HUF

HUF



FOR:  
PER:

# SUZUKI

Technical specifications for the six keys shown:

- Key 1:** P295, 264, TE KEY, SZ12TE, U ..... 1-2000
- Key 2:** P443, 264, MH KEY, SZ12MH, U ..... 1-2000
- Key 3:** P295, 264, FH FLIP, SZ12FH, U ..... 1-2000
- Key 4:** P295, 288 1806, TE KEY, SZ11RTE, ..... 18100-19299, ..... 19300-19617
- Key 5:** P443, 288 1806, MH KEY, SZ11RMH, ..... 18100-19299, ..... 19300-19617
- Key 6:** P443, 288 1806, FH FLIP, SZ11RFH, ..... 18100-19299, ..... 19300-19617

FOR:  
PER:

# SUZUKI

Technical specifications for the four keys shown:

- Key 1:** P361, 264 1411 3124, HU133RT14, ..... 50001-51308, U ..... 1-2000, IP ..... 5001-6308
- Key 2:** P460, 264 1411 3124, TE KEY, HU133RTE, ..... 50001-51308, U ..... 1-2000, IP ..... 5001-6308
- Key 3:** P443, 264 1411 3124, MH KEY, HU133RMH, ..... 50001-51308, U ..... 1-2000, IP ..... 5001-6308
- Key 4:** P443, 264 1411 3124, FH FLIP, HU133RFH, ..... 50001-51308, U ..... 1-2000, IP ..... 5001-6308

HUF

HUF



FOR:  
PER:

# SUZUKI

**P317**  
8/110

**DW05AP**  
V . . . . 1-1200

**P295**  
8/264

**DW05FH** (FH FLIP)  
T . . . . 1-1200  
L . . . . 1-1200  
V . . . . 1-1200  
V . . . . 2001-3200

**SZ12T4** (TE KEY)  
U . . . . 1-2000

**P460**  
8/1552 2756

**SZ22TE** (TE KEY)  
. . . . . 25001-26200

**P443**  
8/1552 2756

**SZ22MH** (MH KEY)  
. . . . . 25001-26200

**SZ22FH** (FH FLIP)  
. . . . . 25001-26200

FOR:  
PER:

# SUZUKI

**P361**  
8/10/264 1411 3124

**HU133RT12**  
. . . . . 50001-51308

**HU133RT14**  
. . . . . 50001-51308  
U . . . . 1-2000  
IP . . . . 5001-6308

**P460**  
8/10/264 1411 3124

**HU133RTE** (TE KEY)  
. . . . . 50001-51308  
U . . . . 1-2000  
IP . . . . 5001-6308

**P443**  
8/10/264 1411 3124

**HU133RMH** (MH KEY)  
. . . . . 50001-51308  
U . . . . 1-2000  
IP . . . . 5001-6308

**HU133RFH** (FH FLIP)  
. . . . . 50001-51308  
U . . . . 1-2000  
IP . . . . 5001-6308

HUF

HUF



FOR:  
PER:

# SUZUKI

**SZ11RTE**  
..... 18100-19299  
..... 19300-19617

**SZ11RMH**  
..... 18100-19299  
..... 19300-19617

**SZ11RFH**  
..... 18100-19299  
..... 19300-19617

**SZ12TE**  
U ..... 1-2000

**SZ12MH**  
U ..... 1-2000

**SZ12FH**  
U ..... 1-2000

**SZ11RT4**  
..... 18100-19299  
..... 19300-19617

FOR:  
PER:

# SUZUKI

**HU87RT5**  
..... 50001-51308

**HU87RFH**  
..... 50001-51308

**SZ11R**  
..... 18100-19299

**SZ11RP**  
..... 18100-19299

**GM30AP**  
..... 10001-15000

**B111-PT**  
G ..... 0-3631

**HU87RT9**  
..... 50001-51308





FOR:  
PER:

# TATA

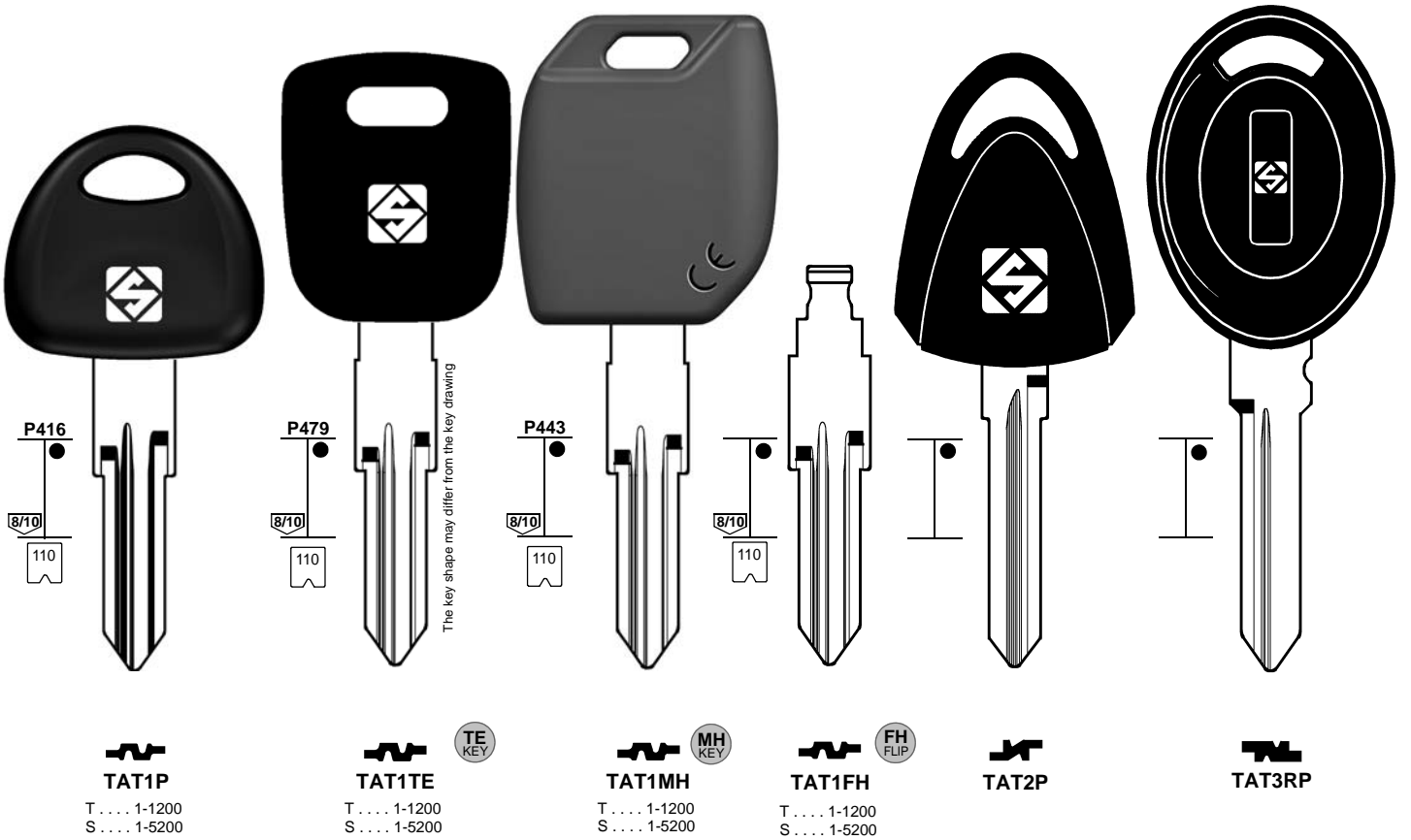

FOR:  
PER:

# TOYOTA

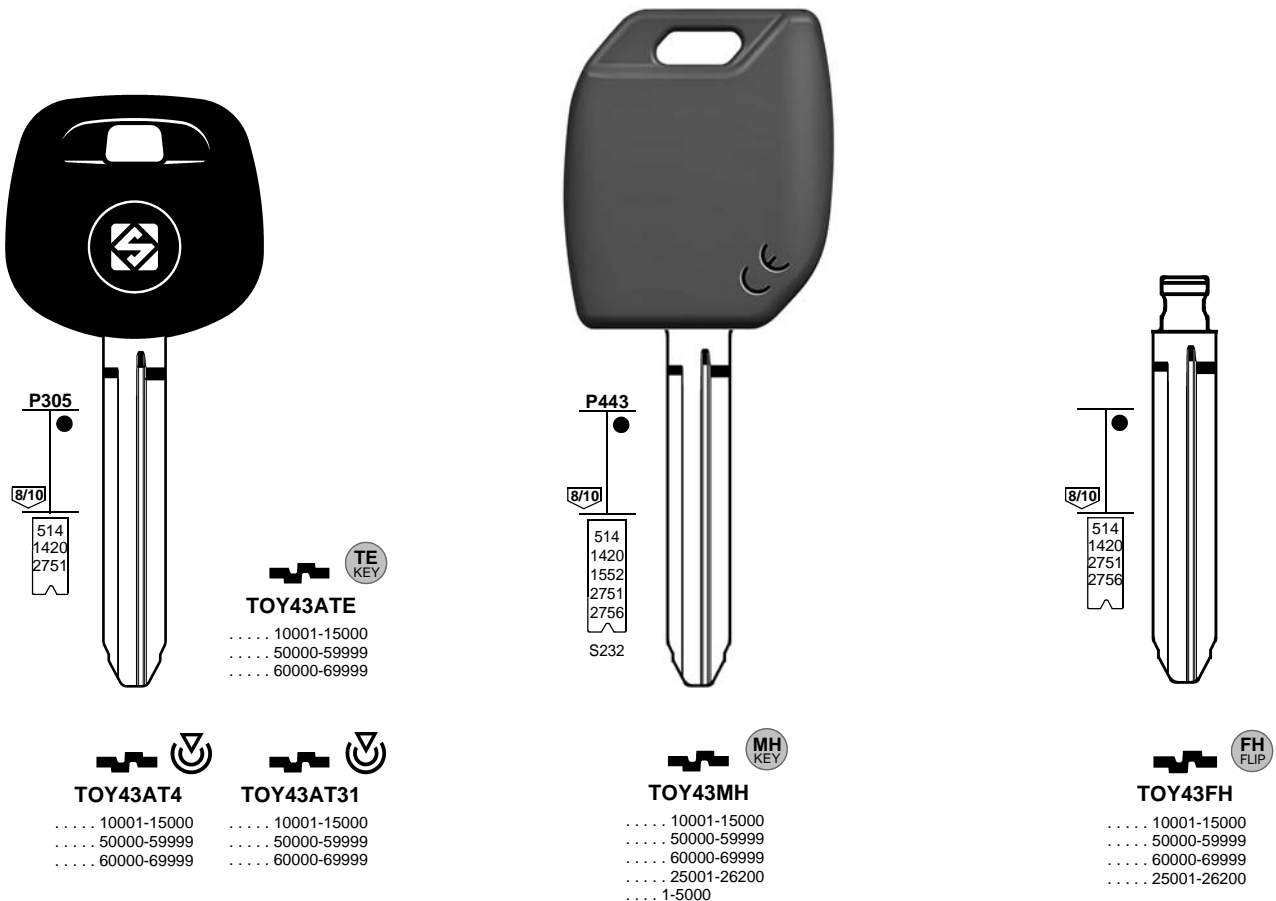



FOR:  
PER:

# TOYOTA

**TOY44**  
..... 10001-15000

**TOY43P**  
..... 10001-15000

**TOY43T2**  
..... 10001-15000  
..... 50000-59999  
..... 60000-69999

**TOY43TE**  
..... 10001-15000  
..... 50000-59999  
..... 60000-69999

**TOY43MH**  
..... 10001-15000  
..... 50000-59999  
..... 60000-69999  
..... 25001-26200  
..... 1-5000

**TOY43FH**  
..... 10001-15000  
..... 50000-59999  
..... 60000-69999  
..... 25001-26200

**TOY43AT4**  
..... 10001-15000  
..... 50000-59999  
..... 60000-69999

**TOY43AT31**  
..... 10001-15000  
..... 50000-59999  
..... 60000-69999

FOR:  
PER:

# TOYOTA

**TOY47BP**  
T ..... (VALET) 1-13284  
T ..... (MASTER) 1-13284  
..... (VALET) 1-13284  
..... (MASTER) 1-13284

**TOY47TE**  
..... 1-13284  
T ..... 1-13284

**TOY47T4**  
..... 1-13284  
T ..... 1-13284

**TOY47MH**  
..... 1-13284  
T ..... 1-13284

**TOY47FH**  
..... 1-13284  
T ..... 1-13284

**VA6MH**  
..... 1234Q5678H  
..... ABCDEF  
..... 12897-A9999

**VA6FH**  
..... 12897-A9999  
..... ABCDEF  
..... 1234Q5678H

HUF - VALEO



FOR:  
PER:

# TOYOTA

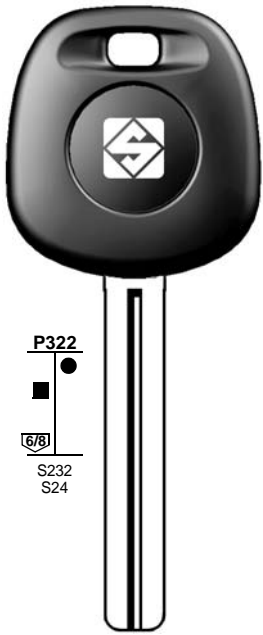

P322

S232  
S24



**TOY40BT4**  
..... 1-5000



P450

S232  
S24



**TOY40BTE**  
..... 1-5000

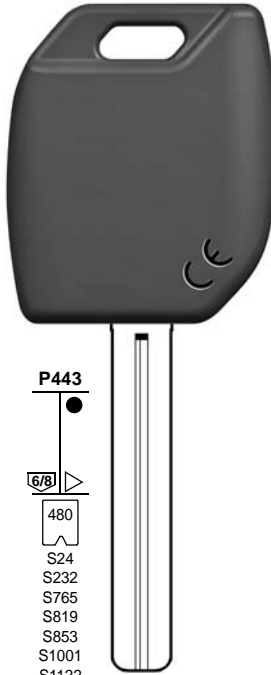

P443

480  
S24  
S232  
S765  
S819  
S853  
S1001  
S1122  
S1150  
S1356



**TOY40MH**  
..... 1-5000  
L ..... 0001-1000  
G ..... 0001-2500  
J ..... 0001-2500  
K ..... 0001-2500  
P ..... 0001-2500  
..... 30001-31200

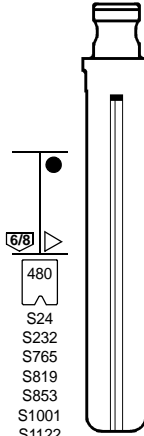

480  
S24  
S232  
S765  
S819  
S853  
S1001  
S1122  
S1150  
S1356



**TOY40FH**  
..... 1-5000  
L ..... 0001-1000  
J ..... 0001-2500

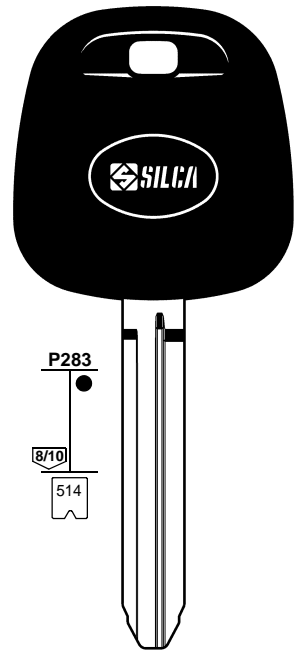

P283

514



**TOY43T3**  
.....  
10001-15000  
**TOY43TE**  
.....  
10001-15000  
50000-59999  
60000-69999

FOR:  
PER:

# TOYOTA

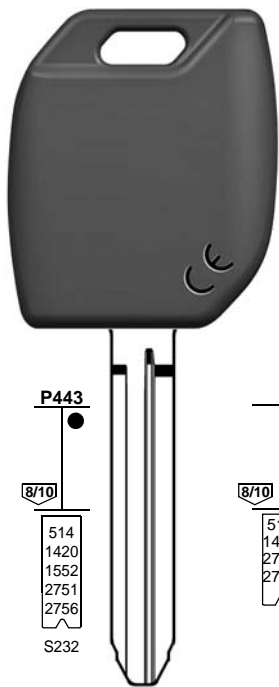

P443

514  
1420  
1552  
2751  
2756  
S232



**TOY43MH**  
..... 10001-15000  
..... 50000-59999  
..... 60000-69999  
..... 25001-26200  
..... 1-5000



514  
1420  
2751  
2756



**TOY43FH**  
..... 10001-15000  
..... 50000-59999  
..... 60000-69999  
..... 25001-26200

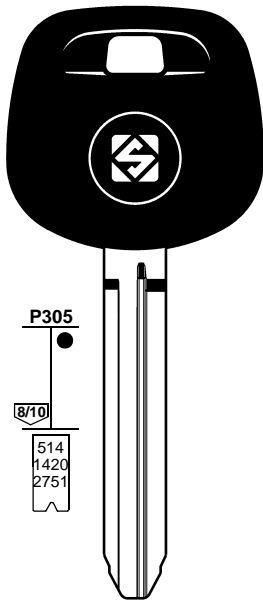

P305

514  
1420  
2751

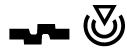

**TOY43AT4**  
..... 10001-15000  
..... 50000-59999  
..... 60000-69999

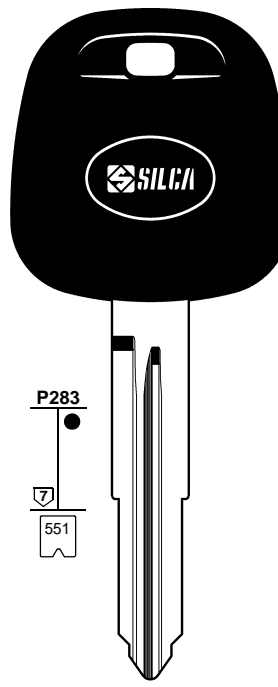

P283

551



**TOY46RTE**  
N ..... 1-2000

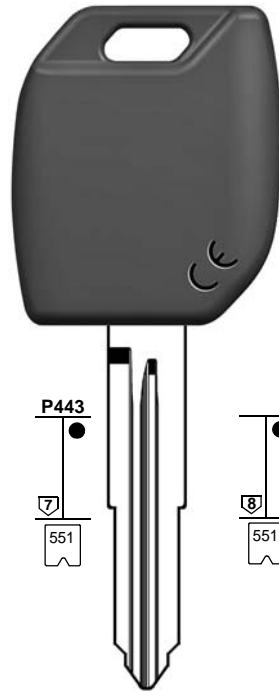

P443

551



**TOY46RMH**  
N ..... 1-2000

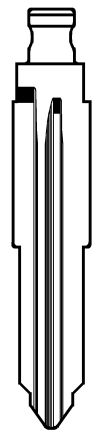

551



**TOY46RFH**  
N ..... 1-2000



**TOY46RT3**  
N ..... 1-2000



FOR:  
PER:

# TOYOTA

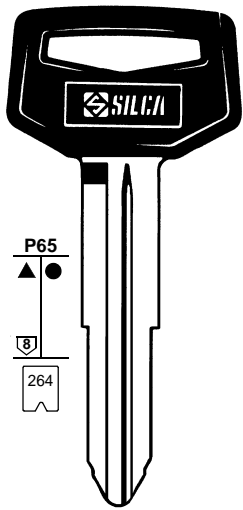

P65  
▲ ●  
8  
264

**TOY38RP**  
W ..... 1-2409  
P ..... 1-2390  
G ..... 1-2377  
X ..... 1-2248

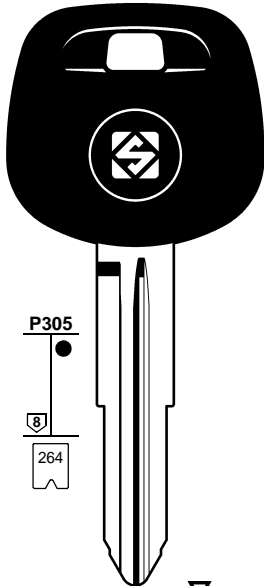

P305  
●  
8  
264

**TOY41RAT4**  
G ..... 1-2377  
P ..... 1-2390  
X ..... 1-2248  
**TE KEY**

**TOY41RATE**  
D ..... 1-3000  
G ..... 1-2377  
P ..... 1-2390  
X ..... 1-2248

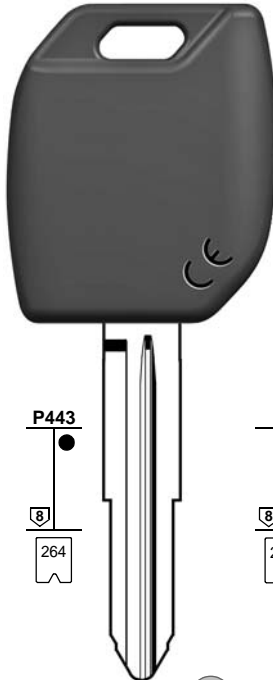

P443  
●  
8  
264

**TOY41RMH**  
D ..... 1-3000  
D ..... 3001-4000  
G ..... 1-2377  
P ..... 1-2390  
X ..... 1-2248  
**MH KEY**

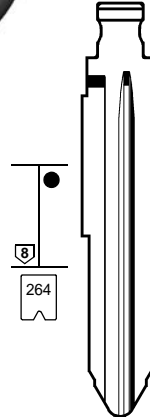

●  
8  
264

**TOY41RFH**  
G ..... 1-2377  
P ..... 1-2390  
X ..... 1-2248  
**FH FLIP**

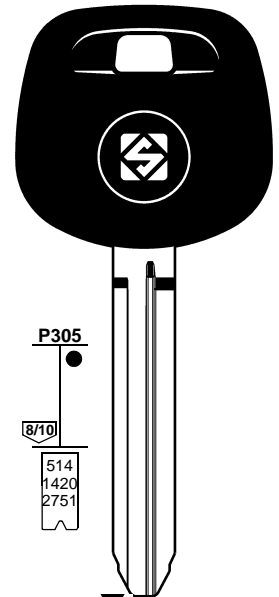

P305  
●  
8/10  
514  
1420  
2751

**TOY43AT31**  
..... 10001-15000  
..... 50000-59999  
..... 60000-69999  
**TE KEY**

**TOY43ATE**  
..... 10001-15000  
..... 50000-59999  
..... 60000-69999

**TOY43AT4**  
..... 10001-15000  
..... 50000-59999  
..... 60000-69999

FOR:  
PER:

# TOYOTA

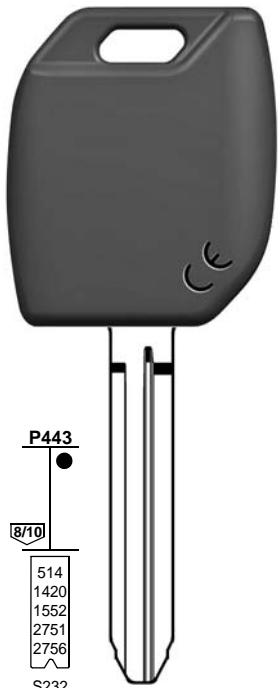

P443  
●  
8/10  
514  
1420  
1552  
2751  
2756  
S232

**TOY43MH**  
..... 10001-15000  
..... 50000-59999  
..... 60000-69999  
..... 25001-26200  
..... 1-5000  
**MH KEY**

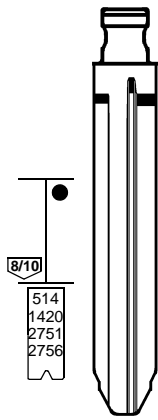

●  
8/10  
514  
1420  
2751  
2756

**TOY43FH**  
..... 10001-15000  
..... 50000-59999  
..... 60000-69999  
..... 25001-26200  
**FH FLIP**

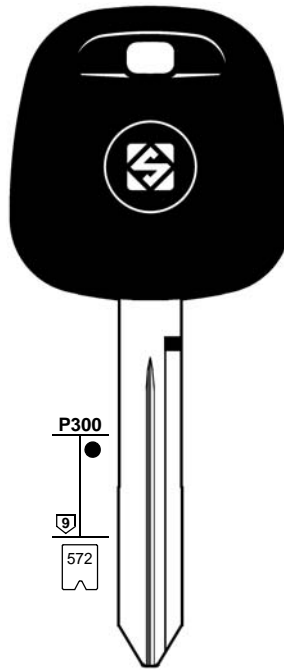

P300  
●  
9  
572

**TOY47TE**  
..... 1-13284  
T ..... 1-13284  
**TE KEY**

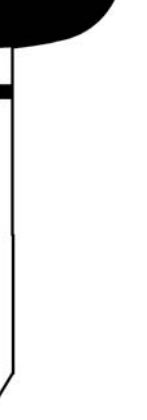

●  
9  
572

**TOY47T4**  
..... 1-13284  
T ..... 1-13284

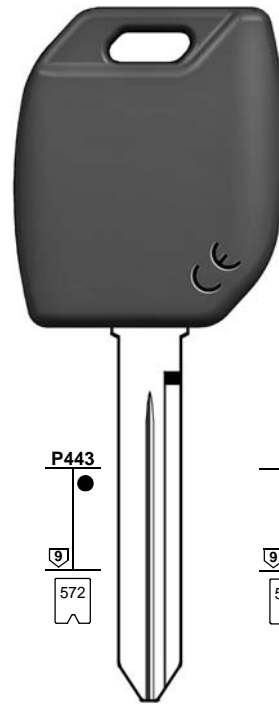

P443  
●  
9  
572

**TOY47MH**  
..... 1-13284  
T ..... 1-13284  
**MH KEY**

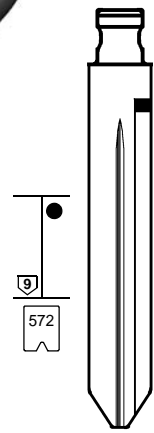

●  
9  
572

**TOY47FH**  
..... 1-13284  
T ..... 1-13284  
**FH FLIP**





FOR:  
PER:

# TOYOTA

**P322**  
S232  
S24

**P450**  
S232  
S24

**P443**  
480  
S24  
S232  
S765  
S819  
S853  
S1001  
S1122  
S1150  
S1356

**P305**  
514  
1420  
2751

**TE KEY**  
**TOY43ATE**  
..... 10001-15000  
..... 50000-59999  
..... 60000-69999

**TOY40BT4**  
..... 1-5000

**TE KEY**  
**TOY40BTE**  
..... 1-5000

**MH KEY**  
**TOY40MH**  
..... 1-5000  
L ..... 0001-1000  
G ..... 0001-2500  
J ..... 0001-2500  
K ..... 0001-2500  
P ..... 0001-2500  
..... 30001-31200

**FH FLIP**  
**TOY40FH**  
..... 1-5000  
L ..... 0001-1000  
J ..... 0001-2500

**TOY43AT4**  
..... 10001-15000  
..... 50000-59999  
..... 60000-69999

**TOY43AT31**  
..... 10001-15000  
..... 50000-59999  
..... 60000-69999

FOR:  
PER:

# TOYOTA

**P443**  
8/10  
514  
1420  
1552  
2751  
2756  
S232

**P322**  
S397  
S855

**P450**  
S397  
S855

**P443**  
S397  
S855

**MH KEY**  
**TOY43MH**  
..... 10001-15000  
..... 50000-59999  
..... 60000-69999  
..... 25001-26200  
..... 1-5000

**FH FLIP**  
**TOY43FH**  
..... 10001-15000  
..... 50000-59999  
..... 60000-69999  
..... 25001-26200

**TOY48BT4**  
..... 40000-49999

**TE KEY**  
**TOY48BTE**  
..... 40000-49999

**MH KEY**  
**TOY48MH**  
..... 40000-49999

**FH FLIP**  
**TOY48FH**  
..... 40000-49999



FOR:  
PER:

# TOYOTA

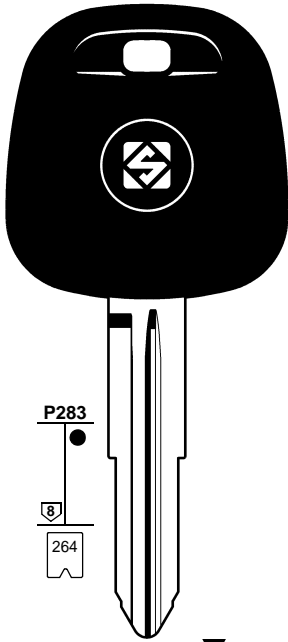

P283  
8  
264



**TOY41RT4**

G . . . . 1-2377  
P . . . . 1-2390  
X . . . . 1-2248



**TOY41RTE**

D . . . . 1-3000  
G . . . . 1-2377  
P . . . . 1-2390  
X . . . . 1-2248

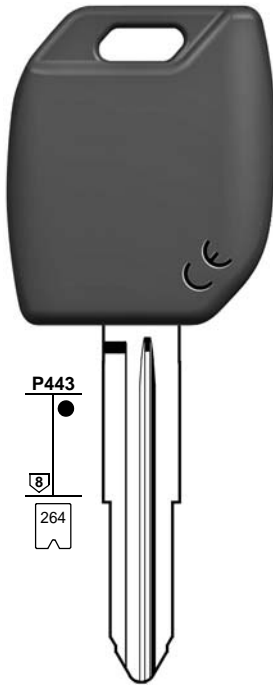

P443  
8  
264



**TOY41RMH**

D . . . . 1-3000  
D . . . . 3001-4000  
G . . . . 1-2377  
P . . . . 1-2390  
X . . . . 1-2248

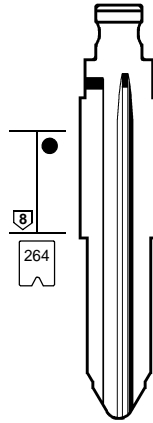

8  
264



**TOY41RFH**

G . . . . 1-2377  
P . . . . 1-2390  
X . . . . 1-2248

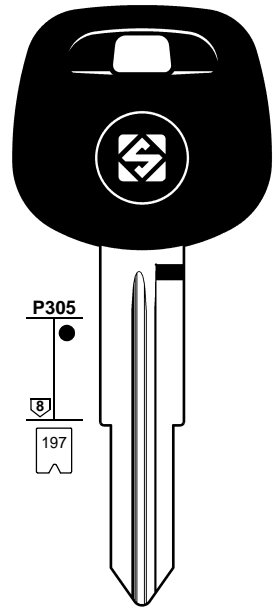

P305  
8  
197



**TOY42AT5**

S . . . . 1-2878

FOR:  
PER:

# TOYOTA

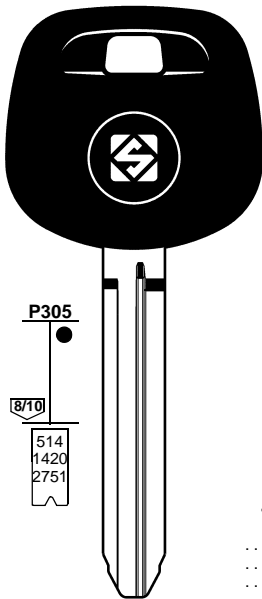

P305  
8/10  
514  
1420  
2751



**TOY43AT4**

. . . . . 10001-15000  
. . . . . 50000-59999  
. . . . . 60000-69999



**TOY43ATE**

. . . . . 10001-15000  
. . . . . 50000-59999  
. . . . . 60000-69999



**TOY43AT31**

. . . . . 10001-15000  
. . . . . 50000-59999  
. . . . . 60000-69999

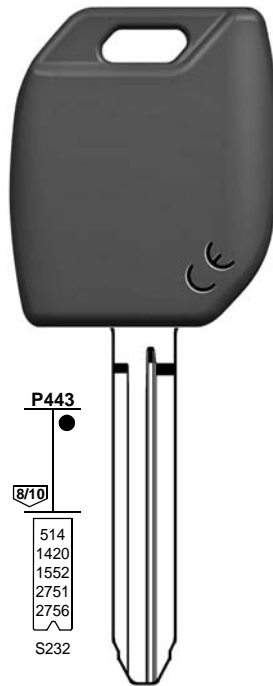

P443  
8/10  
514  
1420  
1552  
2751  
2756  
S232



**TOY43MH**

. . . . . 10001-15000  
. . . . . 50000-59999  
. . . . . 60000-69999  
. . . . . 25001-26200  
. . . . . 1-5000

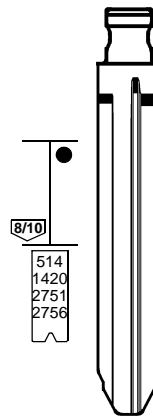

8/10  
514  
1420  
2751  
2756



**TOY43FH**

. . . . . 10001-15000  
. . . . . 50000-59999  
. . . . . 60000-69999  
. . . . . 25001-26200



FOR:  
PER:

# TOYOTA



**TOY43P**

..... 10001-15000

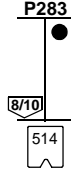

**TOY43T3**

..... 10001-15000



**TOY43TE**

.....  
10001-15000  
50000-59999  
60000-69999

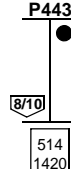

**TOY43MH**

..... 10001-15000  
..... 50000-59999  
..... 60000-69999  
..... 25001-26200  
..... 1-5000

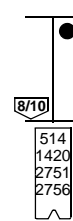
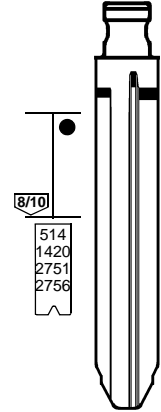

**TOY43FH**

..... 10001-15000  
..... 50000-59999  
..... 60000-69999  
..... 25001-26200

FOR:  
PER:

# TOYOTA

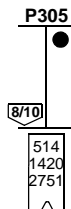
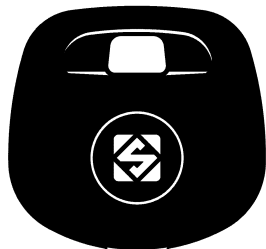

**TOY43ATE**

..... 10001-15000  
..... 50000-59999  
..... 60000-69999



**TOY43AT4**

..... 10001-15000  
..... 50000-59999  
..... 60000-69999



**TOY43AT31**

..... 10001-15000  
..... 50000-59999  
..... 60000-69999

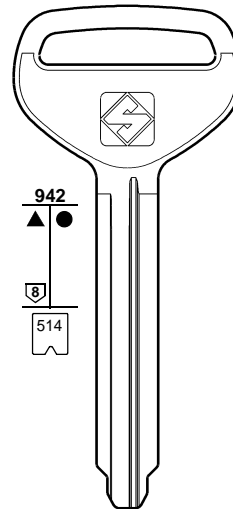

**TOY44**

..... 10001-15000



FOR:  
PER:

# TOYOTA

**TOY41RAT5**  
G ..... 1-2377  
P ..... 1-2390  
X ..... 1-2248

**TOY41RT4**  
G ..... 1-2377  
P ..... 1-2390  
X ..... 1-2248

**TOY41RMH**  
D ..... 1-3000  
D ..... 3001-4000  
G ..... 1-2377  
P ..... 1-2390  
X ..... 1-2248

**TOY41RFH**  
G ..... 1-2377  
P ..... 1-2390  
X ..... 1-2248

**TOY43AT31**  
..... 10001-15000  
..... 50000-59999  
..... 60000-69999

**TOY43ATE**  
..... 10001-15000  
..... 50000-59999  
..... 60000-69999

**TOY41RATE**  
D ..... 1-3000  
G ..... 1-2377  
P ..... 1-2390  
X ..... 1-2248

**TOY41RTE**  
D ..... 1-3000  
G ..... 1-2377  
P ..... 1-2390  
X ..... 1-2248

FOR:  
PER:

# TOYOTA

**TOY43MH**  
..... 10001-15000  
..... 50000-59999  
..... 60000-69999  
..... 25001-26200  
..... 1-5000

**TOY43FH**  
..... 10001-15000  
..... 50000-59999  
..... 60000-69999  
..... 25001-26200

**TOY47TE**  
..... 1-13284  
T ..... 1-13284

**TOY47T4**  
..... 1-13284  
T ..... 1-13284

**TOY47MH**  
..... 1-13284  
T ..... 1-13284

**TOY47FH**  
..... 1-13284  
T ..... 1-13284





FOR:  
PER:

# TOYOTA JAPAN



P322  
S232  
S24

**TOY40BT4**  
..... 1-5000



P450  
S232  
S24

**TOY40BTE**  
..... 1-5000

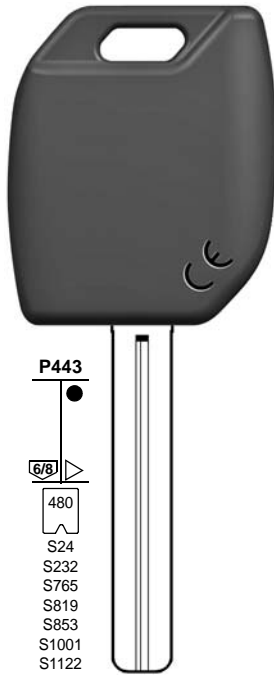

P443  
480  
S24  
S232  
S765  
S819  
S853  
S1001  
S1122  
S1150  
S1356

**TOY40MH**  
..... 1-5000  
L ..... 0001-1000  
G ..... 0001-2500  
J ..... 0001-2500  
K ..... 0001-2500  
P ..... 0001-2500  
..... 30001-31200

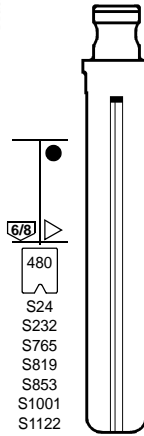

P305  
480  
S24  
S232  
S765  
S819  
S853  
S1001  
S1122  
S1150  
S1356

**TOY40FH**  
..... 1-5000  
L ..... 0001-1000  
J ..... 0001-2500

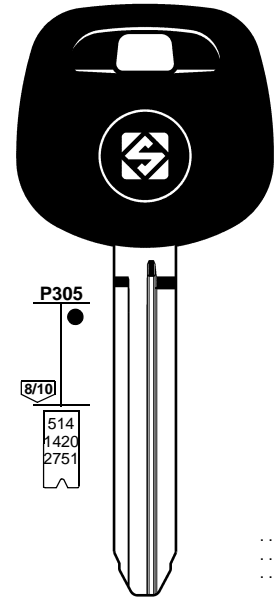

P305  
514  
1420  
2751

**TOY43AT4**  
..... 10001-15000  
..... 50000-59999  
..... 60000-69999

**TOY43ATE**  
..... 10001-15000  
..... 50000-59999  
..... 60000-69999

**TOY43AT31**  
..... 10001-15000  
..... 50000-59999  
..... 60000-69999

FOR:  
PER:

# TOYOTA JAPAN

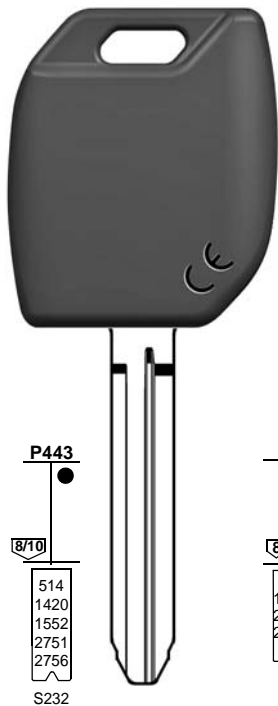

P443  
514  
1420  
1552  
2751  
2756  
S232

**TOY43MH**  
..... 10001-15000  
..... 50000-59999  
..... 60000-69999  
..... 25001-26200  
..... 1-5000

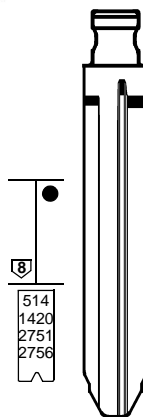

P443  
514  
1420  
2751  
2756

**TOY43FH**  
..... 10001-15000  
..... 50000-59999  
..... 60000-69999  
..... 25001-26200

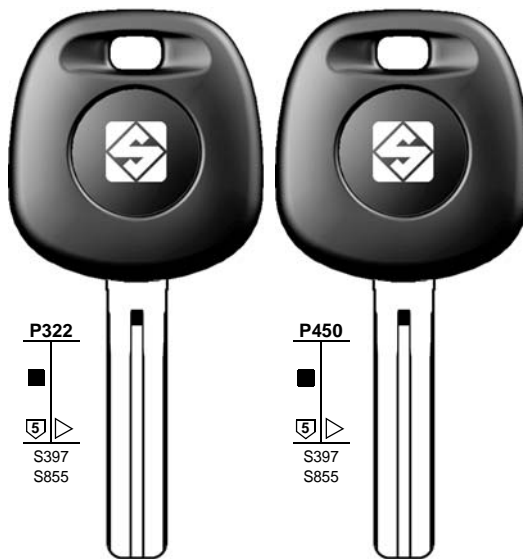

P322  
S397  
S855

**TOY48BT4**  
..... 40000-49999



P450  
S397  
S855

**TOY48BTE**  
..... 40000-49999

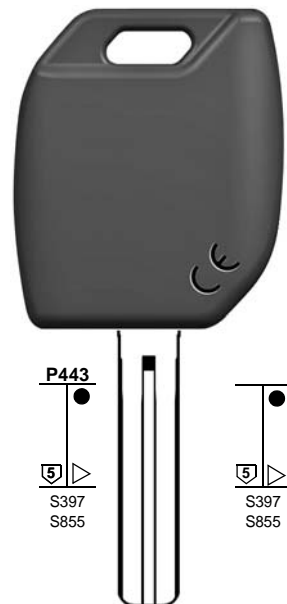

P443  
S397  
S855

**TOY48MH**  
..... 40000-49999

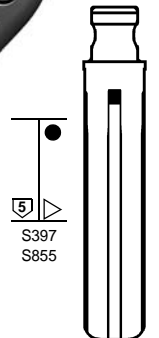

P443  
S397  
S855

**TOY48FH**  
..... 40000-49999



FOR:  
PER:

# TOYOTA JAPAN

**TOY41RAT4**  
G ..... 1-2377  
P ..... 1-2390  
X ..... 1-2248

**TOY41RMH**  
D ..... 1-3000  
D ..... 3001-4000  
G ..... 1-2377  
P ..... 1-2390  
X ..... 1-2248

**TOY41RFH**  
G ..... 1-2377  
P ..... 1-2390  
X ..... 1-2248

**TOY42AT5**  
S ..... 1-2878

**TOY43AT4**  
..... 10001-15000  
..... 50000-59999  
..... 60000-69999

**TOY43AT31**  
..... 10001-15000  
..... 50000-59999  
..... 60000-69999

**TOY41RATE**  
D ..... 1-3000  
G ..... 1-2377  
P ..... 1-2390  
X ..... 1-2248

**TOY43ATE**  
..... 10001-15000  
..... 50000-59999  
..... 60000-69999

FOR:  
PER:

# TOYOTA JAPAN

**TOY43MH**  
..... 10001-15000  
..... 50000-59999  
..... 60000-69999  
..... 25001-26200  
..... 1-5000

**TOY43FH**  
..... 10001-15000  
..... 50000-59999  
..... 60000-69999  
..... 25001-26200

**TOY48BT4**  
..... 40000-49999

**TOY48BT5**  
..... 40000-49999

**TOY48MH**  
..... 40000-49999

**TOY48FH**  
..... 40000-49999

1	2	2a	3	3a	3b	e1+e2		6	42+71	72	43+44a	12	15
						GTI COMPATIBLE		IGNITION					
CAR MAKE MODEL	FROM	TO	SILCA REF.	SILCA REF.	SILCA REF.	COPY	GEN.	TRANSP. TYPE	FAST COPY PLUS RW4 PLUS FAST COPY/RW4	FAST COPY PLUS RW4 PLUS	FAST COPY RW4	STP	
For more info on the uses of car keys, refer to the Silca Electronic Keys Catalogue:													
<b>TOYOTA JAPAN</b>													
ESTIMA	1997	2001	TOY42AT5					PH	33	Y	Y		S11
ESTIMA	2001	2003	TOY43AT4					TEXAS	4C				S11
ESTIMA	2001	2003	TOY43MH	TOY43ATE	TOY43FH	Y	Y	TEXAS	4C	Y	P-BOX		
ESTIMA	2003		TOY43AT31					TEX / CR	67				
ESTIMA	2003		TOY43MH	TOY43ATE	TOY43FH	Y	Y	TEX / CR	67	Y	P-BOX		
FUN CARGO	2003	2005	TOY43AT31					TEX / CR	67				I
FUN CARGO	2003	2005	TOY43MH	TOY43ATE	TOY43FH	Y	Y	TEX / CR	67	Y	P-BOX		
GAIA	1999	2004	TOY43AT4					TEXAS	4C				E
GAIA	1999	2004	TOY43MH	TOY43ATE	TOY43FH	Y	Y	TEXAS	4C	Y	P-BOX		
IPSUM	1996	2003	TOY43AT4					TEXAS	4C				S11
IPSUM	1996	2003	TOY43MH	TOY43ATE	TOY43FH	Y	Y	TEXAS	4C	Y	P-BOX		
IPSUM	2003		TOY43AT31					TEX / CR	67				I
IPSUM	2003		TOY43MH	TOY43ATE	TOY43FH	Y	Y	TEX / CR	67	Y	P-BOX		
ISIS	2003		TOY43AT31					TEX / CR	67				I
ISIS	2003		TOY43MH	TOY43ATE	TOY43FH	Y	Y	TEX / CR	67	Y	P-BOX		
IST	2003		TOY43AT31					TEX / CR	67				I
IST	2003		TOY43MH	TOY43ATE	TOY43FH	Y	Y	TEX / CR	67	Y	P-BOX		
KLUGER	2001	2003	TOY43AT4					TEXAS	4C				E
KLUGER	2001	2003	TOY43MH	TOY43ATE	TOY43FH	Y	Y	TEXAS	4C	Y	P-BOX		
KLUGER	2003		TOY43AT31					TEX / CR	67				
KLUGER	2003		TOY43MH	TOY43ATE	TOY43FH	Y	Y	TEX / CR	67	Y	P-BOX		
LAND CRUISER PRADO	2000	2002	TOY48BT4					TEXAS	4C				S11
LAND CRUISER PRADO	2000	2002	TOY43AT4					TEXAS	4C				S11
LAND CRUISER PRADO	2000	2002	TOY48MH	TOY48BTE	TOY48FH	Y	Y	TEXAS	4C	Y	P-BOX		
LAND CRUISER PRADO	2000	2002	TOY43MH	TOY43ATE	TOY43FH	Y	Y	TEXAS	4C	Y	P-BOX		
LAND CRUISER PRADO	2002	2005	TOY43AT31					TEX / CR	67				I
LAND CRUISER PRADO	2002	2005	TOY43MH	TOY43ATE	TOY43FH	Y	Y	TEX / CR	67	Y	P-BOX		
MARK X	2004		TOY43AT31					TEX / CR	67				
MARK X	2004		TOY43MH	TOY43ATE	TOY43FH	Y	Y	TEX / CR	67	Y	P-BOX		
MARK 2	2000	2006	TOY43AT4					TEXAS	4C				S11
MARK 2	2000	2006	TOY43MH	TOY43ATE	TOY43FH	Y	Y	TEXAS	4C	Y	P-BOX		
NOAH	2004		TOY43AT31					TEX / CR	67				
NOAH	2004		TOY43MH	TOY43ATE	TOY43FH	Y	Y	TEX / CR	67	Y	P-BOX		
OPEN DECK	2000	2005	TOY43AT31					TEX / CR	67				I
OPEN DECK	2000	2005	TOY43MH	TOY43ATE	TOY43FH	Y	Y	TEX / CR	67	Y	P-BOX		
ORIGIN	2000		TOY48BT4					TEXAS	4C				S11
ORIGIN	2000		TOY48MH	TOY48BTE	TOY48FH	Y	Y	TEXAS	4C	Y	P-BOX		
PLATZ	1999	2002	TOY41RAT4					TEXAS	4C				S11
PLATZ	1999	2002	TOY41RAT4					TEXAS	4C				E
PLATZ	1999	2002	TOY41RMH	TOY41RATE	TOY41RFH	Y	Y	TEXAS	4C	Y	P-BOX		
PLATZ	2003	2005	TOY43AT31					TEX / CR	67				
PLATZ	2003	2005	TOY43MH	TOY43ATE	TOY43FH	Y	Y	TEX / CR	67	Y	P-BOX		
PROGRÈS NC300	1998	2006	TOY48BT4					TEXAS	4C				S11
PROGRÈS NC300	1998	2006	TOY48MH	TOY48BTE	TOY48FH	Y	Y	TEXAS	4C	Y	P-BOX		
PRONARD	2000	2002	TOY43AT4					TEXAS	4C				S11
PRONARD	2000	2002	TOY43MH	TOY43ATE	TOY43FH	Y	Y	TEXAS	4C	Y	P-BOX		

FOR:  
PER:

# TOYOTA JAPAN

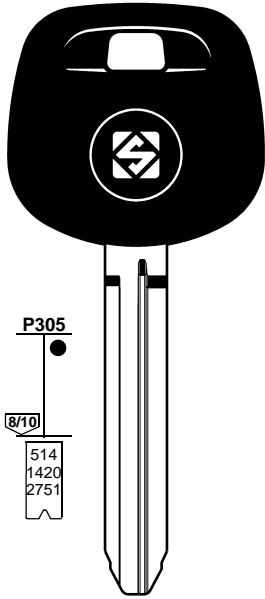

**TOY43AT4**

..... 10001-15000  
 ..... 50000-59999  
 ..... 60000-69999



**TOY43ATE**

..... 10001-15000  
 ..... 50000-59999  
 ..... 60000-69999



P443

8/10

514  
1420  
1552  
2751  
2756

S232



**TOY43MH**

..... 10001-15000  
 ..... 50000-59999  
 ..... 60000-69999  
 ..... 25001-26200  
 ..... 1-5000

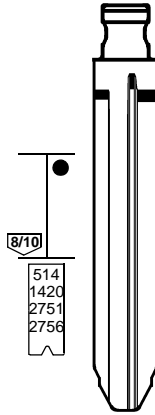

8/10

514  
1420  
2751  
2756



**TOY43FH**

..... 10001-15000  
 ..... 50000-59999  
 ..... 60000-69999  
 ..... 25001-26200

FOR:  
PER:

# TOYOTA JAPAN



P322

5  
S397  
S855



**TOY48BT4**

..... 40000-49999

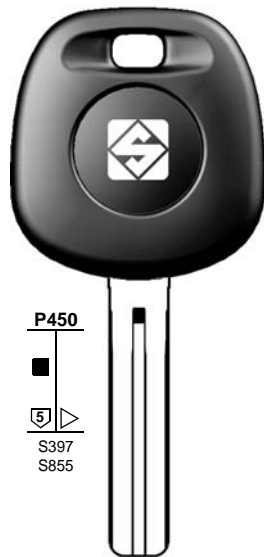

P450

5  
S397  
S855



**TOY48BTE**

..... 40000-49999



P443

5  
S397  
S855



**TOY48MH**

..... 40000-49999

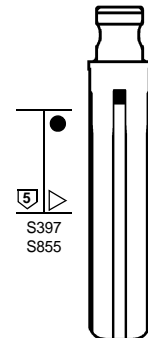

5  
S397  
S855



**TOY48FH**

..... 40000-49999



FOR:  
PER:

# TOYOTA USA

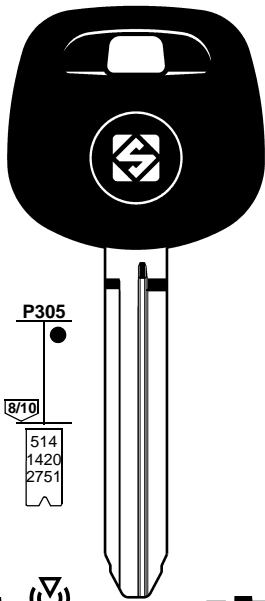

**TOY43AT4**

..... 10001-15000  
..... 50000-59999  
..... 60000-69999



**TOY43ATE**

..... 10001-15000  
..... 50000-59999  
..... 60000-69999



**TOY43AT31**

..... 10001-15000  
..... 50000-59999  
..... 60000-69999

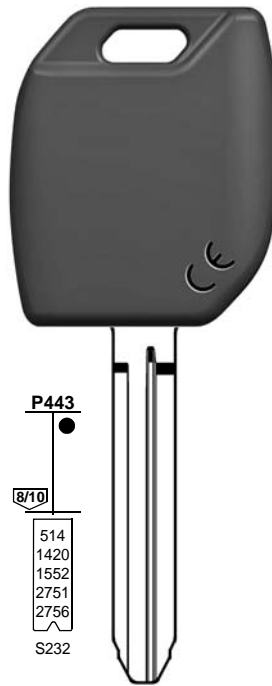

**TOY43MH**

..... 10001-15000  
..... 50000-59999  
..... 60000-69999  
..... 25001-26200  
..... 1-5000

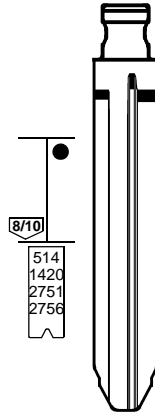

**TOY43FH**

..... 10001-15000  
..... 50000-59999  
..... 60000-69999  
..... 25001-26200

FOR:  
PER:

# TOYOTA USA

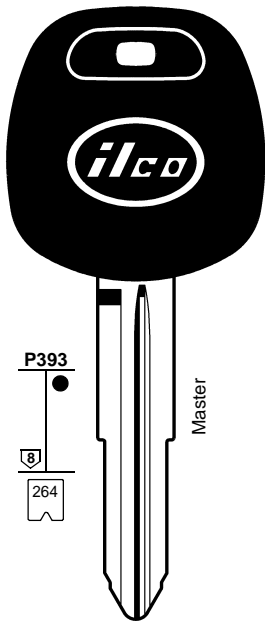

**TOY57-PT**

G .... 1-2377  
P .... 1-2390  
X .... 1-2248

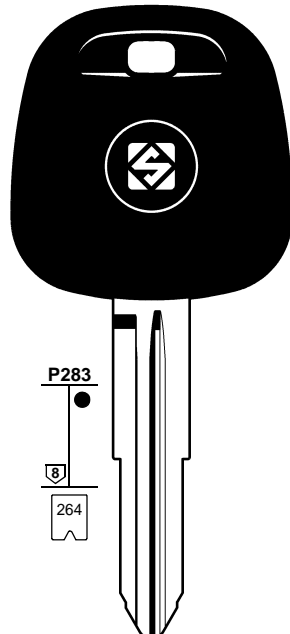

**TOY41RTE**

D .... 1-3000  
G .... 1-2377  
P .... 1-2390  
X .... 1-2248



**TOY41RMH**

D .... 1-3000  
D .... 3001-4000  
G .... 1-2377  
P .... 1-2390  
X .... 1-2248

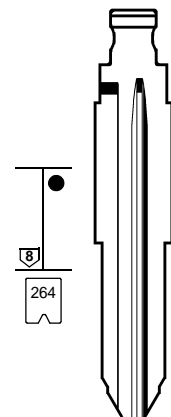

**TOY41RFH**

G .... 1-2377  
P .... 1-2390  
X .... 1-2248

1	2	2a	3	3a	3b	e1+e2		6	42+71	72	43+44a	12	15
						GTI COMPATIBLE		IGNITION					
CAR MAKE MODEL	FROM	TO	SILCA REF.	SILCA REF.	SILCA REF.	COPY	GEN.	TRANSP. TYPE	FAST COPY PLUS RW4 PLUS FAST COPY/RW4	FAST COPY PLUS RW4 PLUS	FAST COPY RW4	STP	
For more info on the uses of car keys, refer to the Silca Electronic Keys Catalogue:													
<b>TOYOTA USA</b>													
4RUNNER	1999	2002	TOY43AT4					TEXAS	4C				E
4RUNNER	1999	2002	TOY43MH	TOY43ATE	TOY43FH	Y	Y	TEXAS	4C	Y	P-BOX		
4RUNNER	2003	2010	TOY43AT31					TEX / CR	67				I
4RUNNER	2003	2010	TOY43MH	TOY43ATE	TOY43FH	Y	Y	TEX / CR	67	Y	P-BOX		
4RUNNER	2010		SMARTKEY					TEX / CR	67				
4RUNNER	2011							TEX / MA	6E				
AVALON	1998	2004	TOY43AT4					TEXAS	4C				E
AVALON	1998	2004	TOY43MH	TOY43ATE	TOY43FH	Y	Y	TEXAS	4C	Y	P-BOX		
AVALON	2005	2011	TOY43AT31					TEX / CR	67				I
AVALON	2005	2011	TOY43MH	TOY43ATE	TOY43FH	Y	Y	TEX / CR	67	Y	P-BOX		
AVALON	2005		SMARTKEY					TEX / CR	67				
AVALON	2012							TEX / MA	6E				
AVANZA	2004		TOY43AT31					TEX / CR	67				I
AVANZA	2004		TOY43MH	TOY43ATE	TOY43FH	Y	Y	TEX / CR	67	Y	P-BOX		
CAMRY	1998	2004	TOY43AT4					TEXAS	4C				E
CAMRY	1998	2004	TOY43MH	TOY43ATE	TOY43FH	Y	Y	TEXAS	4C	Y	P-BOX		
CAMRY	2003	2010	TOY43AT31					TEX / CR	67				I
CAMRY	2003	2010	TOY43MH	TOY43ATE	TOY43FH	Y	Y	TEX / CR	67	Y	P-BOX		
CAMRY	2006		SMARTKEY					TEX / CR	67				
CAMRY	2011							TEX / MA	6E				
COROLLA	2005	2010	TOY43AT31					TEX / CR	67				I
COROLLA	2005	2010	TOY43MH	TOY43ATE	TOY43FH	Y	Y	TEX / CR	67	Y	P-BOX		
COROLLA	2010							TEX / MA	6E				
FJ CRUISER	2007	2010	TOY43AT31					TEX / CR	67				I
FJ CRUISER	2007	2010	TOY43MH	TOY43ATE	TOY43FH	Y	Y	TEX / CR	67	Y	P-BOX		
FJ CRUISER	2011							TEX / MA	6E				
HIACE	2006		TOY43AT31					TEX / CR	67				I
HIACE	2006		TOY43MH	TOY43ATE	TOY43FH	Y	Y	TEX / CR	67	Y	P-BOX		
HIGHLANDER	2001	2003	TOY43AT4					TEXAS	4C				E
HIGHLANDER	2001	2003	TOY43MH	TOY43ATE	TOY43FH	Y	Y	TEXAS	4C	Y	P-BOX		
HIGHLANDER	2004	2010	TOY43AT31					TEX / CR	67				I
HIGHLANDER	2004	2010	TOY43MH	TOY43ATE	TOY43FH	Y	Y	TEX / CR	67	Y	P-BOX		
HIGHLANDER	2006		SMARTKEY					TEX / CR	67				
HIGHLANDER	2011							TEX / MA	6E				
HILUX	2004	2009	TOY43AT31					TEX / CR	67				I
LAND CRUISER	1998	2002	TOY43AT4					TEXAS	4C				E
LAND CRUISER	1998	2002	TOY43MH	TOY43ATE	TOY43FH	Y	Y	TEXAS	4C	Y	P-BOX		
LAND CRUISER	2003	2008	TOY43AT31					TEX / CR	67				I
LAND CRUISER	2003	2008	TOY43MH	TOY43ATE	TOY43FH	Y	Y	TEX / CR	67	Y	P-BOX		
LAND CRUISER	2009		SMARTKEY					TEX / CR	67				
MATRIX	2005	2010	TOY43AT31					TEX / CR	67				I
MATRIX	2005	2010	TOY43MH	TOY43ATE	TOY43FH	Y	Y	TEX / CR	67	Y	P-BOX		
MATRIX	2011							TEX / MA	6E				
MR2	2001	2005	TOY57-PT					TEXAS	4C				E
MR2	2001	2005	TOY41RMH	TOY41RTE	TOY41RFH	Y	Y	TEXAS	4C	Y	P-BOX		
PRIUS	2001	2003	TOY43AT4					TEXAS	4C				E



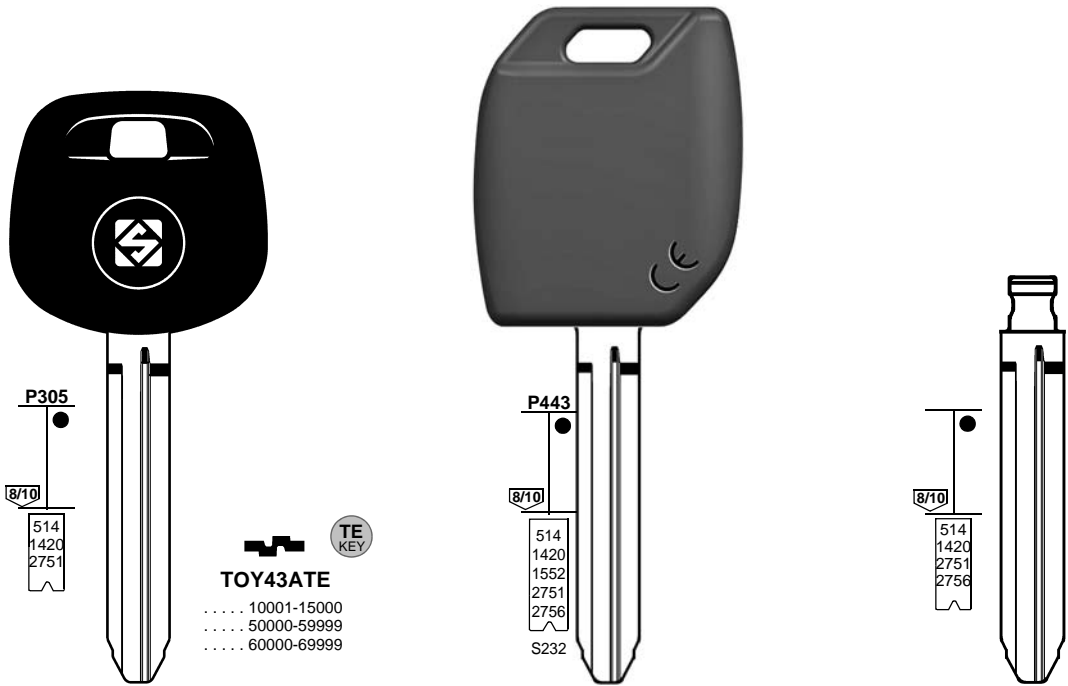

FOR:  
PER:

# TOYOTA USA



  
**TOY43AT4**  
..... 10001-15000  
..... 50000-59999  
..... 60000-69999

  
**TOY43AT31**  
..... 10001-15000  
..... 50000-59999  
..... 60000-69999

  
**TOY43MH**  
..... 10001-15000  
..... 50000-59999  
..... 60000-69999  
..... 25001-26200  
..... 1-5000

  
**TOY43FH**  
..... 10001-15000  
..... 50000-59999  
..... 60000-69999  
..... 25001-26200

FOR:  
PER:

# VOLKSWAGEN

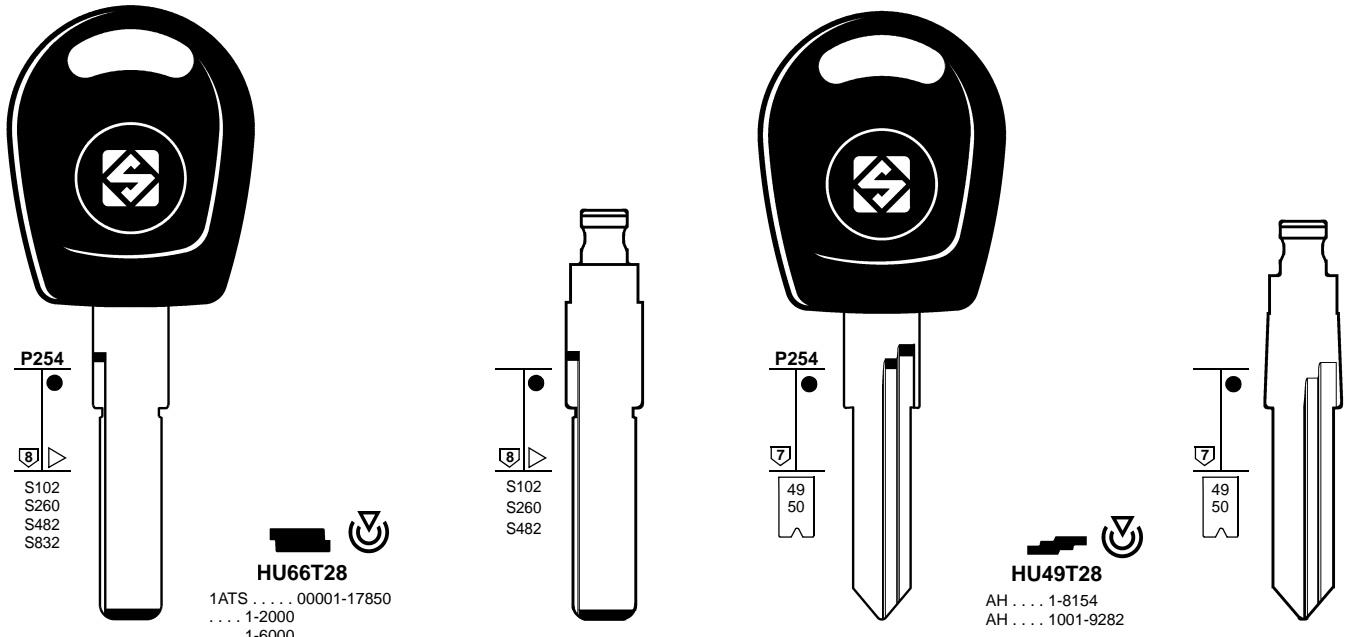



  
**HU66T6**  
1ATS ..... 00001-17850  
..... 1-2000  
..... 1-6000





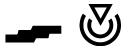











  
**HU66T24**  
1ATS ..... 00001-17850  
..... 1-2000  
..... 1-6000

  
**HU66FH**  
..... 1-2000  
..... 0001-6000

  
**HU49T5**  
AH ..... 1-8154  
AH ..... 1001-9282

  
**HU49T10**  
AH ..... 1-8154  
AH ..... 1001-9282

  
**HU49FH**  
AH ..... 1-8154  
AH ..... 1001-9282

1	2	2a	3	3a	3b	e1+e2		6	42+71	72	43+44a	12	15
						GTI COMPATIBLE		IGNITION 					
CAR MAKE MODEL	FROM	TO	SILCA REF.	SILCA REF.	SILCA REF.	COPY	GEN.	TRANSP. TYPE	FAST COPY PLUS RW4 PLUS FAST COPY/RW4	FAST COPY PLUS RW4 PLUS	FAST COPY RW4	STP	
													
For more info on the uses of car keys, refer to the Silca Electronic Keys Catalogue: 													
<b>TOYOTA USA</b>													
PRIUS	2001	2003	TOY43MH	TOY43ATE	TOY43FH	Y	Y	TEXAS	4C	Y	P-BOX		
PRIUS	2004	2008	TOY43AT31					TEX / CR	67				I
PRIUS	2004	2008	TOY43MH	TOY43ATE	TOY43FH	Y	Y	TEX / CR	67	Y	P-BOX		
PRIUS	2009		SMARTKEY					TEX / CR	67				
PRIUS C	2012							TEX / MA	6E				
RAV 4	2006	2010	TOY43AT31					TEX / CR	67				I
RAV 4	2006	2010	TOY43MH	TOY43ATE	TOY43FH	Y	Y	TEX / CR	67	Y	P-BOX		
RAV 4	2011							TEX / MA	6E				
SEQUOIA	2001	2002	TOY43AT4					TEXAS	4C				I
SEQUOIA	2001	2002	TOY43MH	TOY43ATE	TOY43FH	Y	Y	TEXAS	4C	Y	P-BOX		
SEQUOIA	2003	2010	TOY43AT31					TEX / CR	67				I
SEQUOIA	2003	2010	TOY43MH	TOY43ATE	TOY43FH	Y	Y	TEX / CR	67	Y	P-BOX		
SEQUOIA	2011							TEX / MA	6E				
SIENNA	1999	2003	TOY43AT4					TEXAS	4C				E
SIENNA	1999	2003	TOY43MH	TOY43ATE	TOY43FH	Y	Y	TEXAS	4C	Y	P-BOX		
SIENNA	2004	2010	TOY43AT31					TEX / CR	67				I
SIENNA	2004	2010	TOY43MH	TOY43ATE	TOY43FH	Y	Y	TEX / CR	67	Y	P-BOX		
SIENNA	2011							TEX / MA	6E				
SIENNA	2011		SMARTKEY					TEX / CR	67				
SOLARA	2002	2003	TOY43AT4					TEXAS	4C				E
SOLARA	2002	2003	TOY43MH	TOY43ATE	TOY43FH	Y	Y	TEXAS	4C	Y	P-BOX		
SOLARA	2004	2010	TOY43AT31					TEX / CR	67				I
SOLARA	2004	2010	TOY43MH	TOY43ATE	TOY43FH	Y	Y	TEX / CR	67	Y	P-BOX		
TACOMA	2005	2010	TOY43AT31					TEX / CR	67				I
TACOMA	2005	2010	TOY43MH	TOY43ATE	TOY43FH	Y	Y	TEX / CR	67	Y	P-BOX		
TACOMA	2011							TEX / MA	6E				
TUNDRA	2005	2010	TOY43AT31					TEX / CR	67				I
TUNDRA	2005	2010	TOY43MH	TOY43ATE	TOY43FH	Y	Y	TEX / CR	67	Y	P-BOX		
TUNDRA	2011							TEX / MA	6E				
VENZA	2009	2010	TOY43AT31					TEX / CR	67				
VENZA	2009	2010	TOY43MH	TOY43ATE	TOY43FH	Y	Y	TEX / CR	67	Y	P-BOX		
VENZA	2009	2011	SMARTKEY					TEX / CR	67				
VENZA	2011		SMARTKEY					TEX / MA	6E				
VENZA	2011							TEX / MA	6E				
YARIS	2007	2011	TOY43AT31					TEX / CR	67				I
YARIS	2007	2011	TOY43MH	TOY43ATE	TOY43FH	Y	Y	TEX / CR	67	Y	P-BOX		
YARIS	2012							TEX / MA	6E				
<b>VOLKSWAGEN</b>													
BEETLE	1998	2004	HU66T6		HU66FH			MEG / CR	48				
BEETLE	2005	2008	HU66T24		HU66FH			MEG / CR	A1				
BEETLE	2008							MEG / CR	A1				
BORA	1998	2005	HU66T6		HU66FH			MEG / CR	48				
CABRIO	2000	2005	HU66T28		HU66FH			PH / CR	4W	RD	RD		
CADDY	1995	1998	HU49T5		HU49FH			PH	33	Y	Y	S-V	
CADDY	1998	2000	HU49T10		HU49FH			PH / CR	42	Y	Y		
CADDY	2000	2003	HU49T28		HU49FH			PH / CR	4W	RD	RD		

FOR:  
PER:

# VOLKSWAGEN

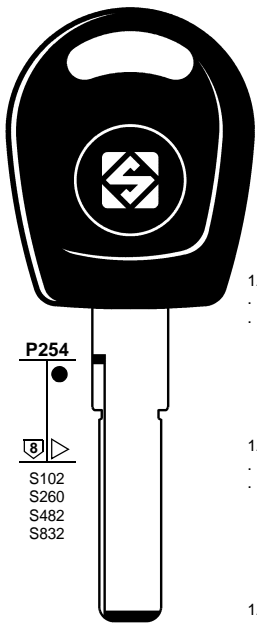

**HU66T28**  
1ATS ..... 00001-17850  
..... 1-2000  
..... 1-6000

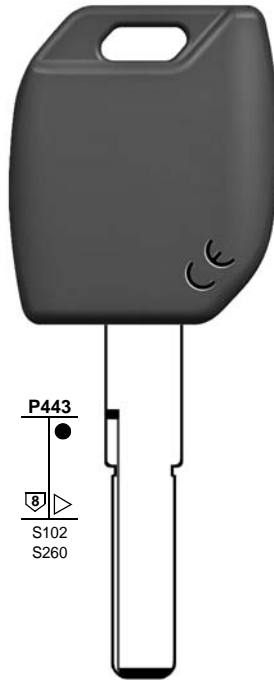

**HU66T24**  
1ATS ..... 00001-17850  
..... 1-2000  
..... 1-6000

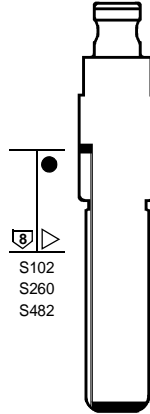

**HU66T10**  
1ATS ..... 00001-17850  
..... 1-2000  
..... 1-6000

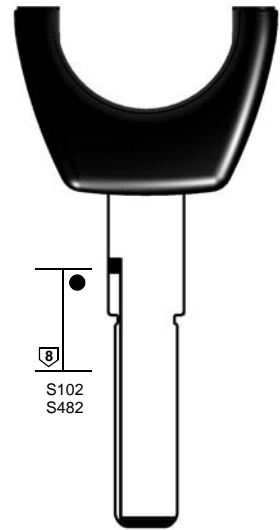

**HU66T5**  
1ATS ..... 00001-17850  
..... 1-2000  
..... 1-6000

**HU66T6**  
1ATS ..... 00001-17850  
..... 1-2000  
..... 1-6000

**HU66MH**  
..... 1-2000  
..... 0001-6000

**HU66FH**  
..... 1-2000  
..... 0001-6000

**HU66CT5**  
..... 1-2000  
1ATS00001-17850

**HU66CT6**  
..... 1-2000

WITTE

FOR:  
PER:

# VOLKSWAGEN

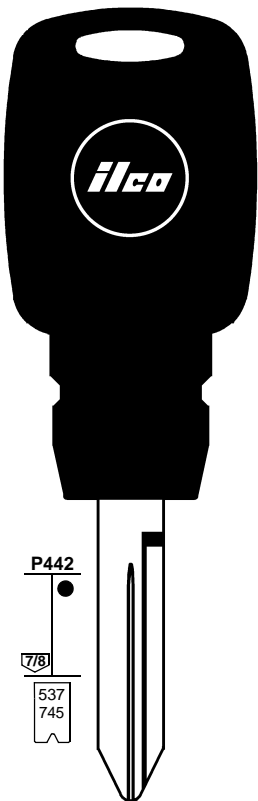

**EK3P-Y170**  
L ..... 1-3580  
M ..... 1-2618

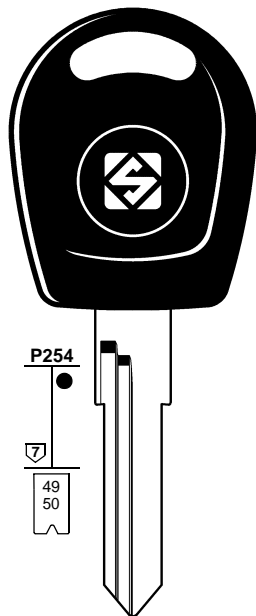

P254  
49  
50

**HU49T6**  
AH ..... 1001-9282

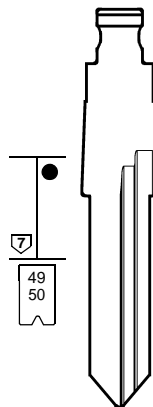

49  
50

**HU49FH**  
AH ..... 1-8154  
AH ..... 1001-9282

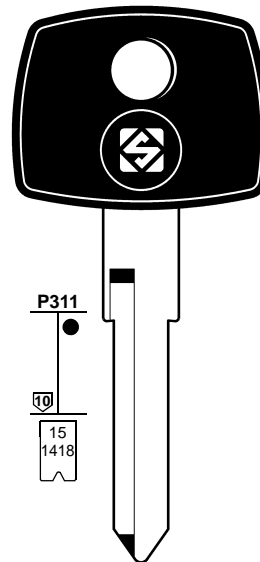

P311  
15  
1418

**YM15T5**  
.. NF ... 1-99 ... 1-99  
HM ... 1-1200  
HM ... 2501-3500  
HM ... 4001-7350  
HM ... 6001-7109  
NF ... 1-1200  
NM ... 2501-3500

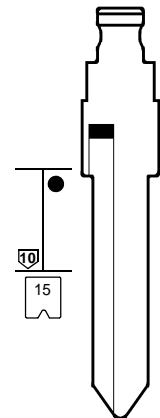

15

**YM15FH**  
NM ... 2501-3500  
.. NF ... 1-99 ... 1-99  
HM ... 1-1200  
HM ... 2501-3500  
HM ... 4001-7350  
HF ... 1-1200

VALEO - YMOS

1	2	2a	3	3a	3b	e1+e2		6	42+71	72	43+44a	12	15
						GTI COMPATIBLE		IGNITION					
CAR MAKE MODEL	FROM	TO	SILCA REF.	SILCA REF.	SILCA REF.	COPY	GEN.	TRANSP. TYPE	FAST COPY PLUS RW4 PLUS FAST COPY/RW4	FAST COPY PLUS RW4 PLUS	FAST COPY RW4	STP	
For more info on the uses of car keys, refer to the Silca Electronic Keys Catalogue:													
<b>VOLKSWAGEN</b>													
CADDY	2004	2007	HU66T24		HU66FH			MEG / CR	A1				
CADDY	2008							MEG / CR	A1				
CRAFTER	2006							MEG / CR	A1				
CROSS GOLF	2006	2007	HU66T24		HU66FH			MEG / CR	A1				
CROSS GOLF	2008							MEG / CR	A1				
EOS	2006	2007	HU66T24		HU66FH			MEG / CR	A1				
EOS	2008							MEG / CR	A1				
EURO VAN	2000	2004	HU66T6		HU66FH			MEG / CR	48				
FOX	2005	2008	HU66T6		HU66FH			MEG / CR	48				
GOLF	1995	1998	HU49T5		HU49FH			PH	33	Y	Y	S-V	
GOLF	1998	2004	HU66T6		HU66FH			MEG / CR	48				
GOLF	2004	2008	HU66T24		HU66FH			MEG / CR	A1				
GOLF	2008							MEG / CR	A1				
GOLF CABRIO	1995	1998	HU49T5		HU49FH			PH	33	Y	Y	S-V	
GOLF CABRIO	1998	2000	HU66T10		HU66FH			PH / CR	42	Y	Y		
GOLF CABRIO	2000	2004	HU66T28		HU66FH			PH / CR	4W	RD	RD		
GOLF CABRIO	2004		HU66T24		HU66FH			MEG / CR	A1				
GOLF GTI	2000	2004	HU66T6		HU66FH			MEG / CR	48				
INDIVIDUAL	2004		HU66T24		HU66FH			MEG / CR	A1				
JETTA	2000	2004	HU66T6		HU66FH			MEG / CR	48				
JETTA	2004	2007	HU66T24		HU66FH			MEG / CR	A1				
JETTA	2008							MEG / CR	A1				
LT 28	2000	2006	YM15T5		YM15FH			TEMIC	12	Y	Y		
LUPO	1998	2000	HU66T10		HU66FH			PH / CR	42	Y	Y		
LUPO	2000	2005	HU66T28		HU66FH			PH / CR	4W	RD	RD		
MULTIVAN	2003	2008	HU66T24		HU66FH			MEG / CR	A1				
MULTIVAN	2009							MEG / CR	A1				
PASSAT	1995	1997	HU49T5		HU49FH			PH	33	Y	Y	S-V	
PASSAT	1997	1998	HU66CT5		HU66FH			MEG	13	Y	Y		
PASSAT	1997	1998	HU66T5		HU66FH			MEG	13	Y	Y		
PASSAT	1998	2004	HU66T6		HU66FH			MEG / CR	48				
PASSAT	1998	2004	HU66CT6		HU66FH			MEG / CR	48				
PASSAT	2004	2005	HU66T24		HU66FH			MEG / CR	A1				
PASSAT	2006							MEG / CR	A1				
PASSAT W8	2002	2004	HU66T6		HU66FH			MEG / CR	48				
PHAETON	2003							PH / CR2	46				
PHAETON	2003		HU66MH					PH / CR2	46	Y	P-BOX		
POLO	1995	1998	HU49T5		HU49FH			PH	33	Y	Y	S-V	
POLO	1998	2000	HU66T10		HU66FH			PH / CR	42	Y	Y		
POLO	2000	2001	HU66T28		HU66FH			PH / CR	4W	RD	RD		
POLO	2001	2005	HU66T6		HU66FH			MEG / CR	48				
POLO	2005	2009	HU66T24		HU66FH			MEG / CR	A1				
POLO	2009							MEG / CR	A1				
ROUTAN	2008							PH / CR2	46				
ROUTAN	2008		EK3P-Y170					PH / CR2	46	Y	P-BOX		
SAVEIRO	1995		HU49RT6					MEG / CR	48				

FOR:  
PER:

# VOLKSWAGEN

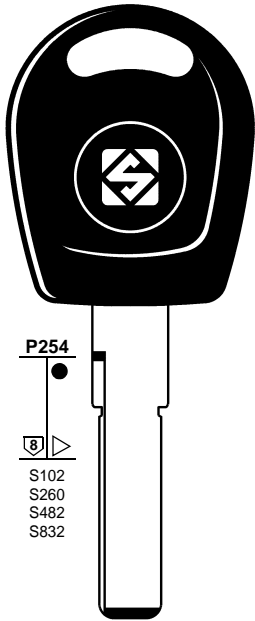

**HU66T28**  
1ATS ..... 00001-17850  
..... 1-2000  
..... 1-6000

P254  
S102  
S260  
S482  
S832

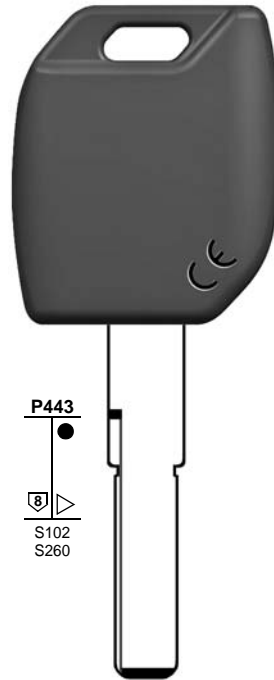

P443  
S102  
S260

**HU66T24**  
1ATS ..... 00001-17850  
..... 1-2000  
..... 1-6000

**HU66T10**  
1ATS ..... 00001-17850  
..... 1-2000  
..... 1-6000

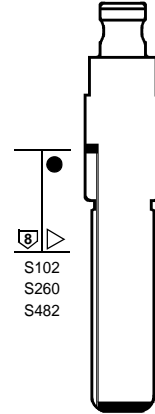

S102  
S260  
S482

**HU66T5**  
1ATS ..... 00001-17850  
..... 1-2000  
..... 1-6000

**HU66T6**  
1ATS ..... 00001-17850  
..... 1-2000  
..... 1-6000

**HU66MH**  
..... 1-2000  
..... 0001-6000

**HU66FH**  
..... 1-2000  
..... 0001-6000

FOR:  
PER:

# VOLKSWAGEN

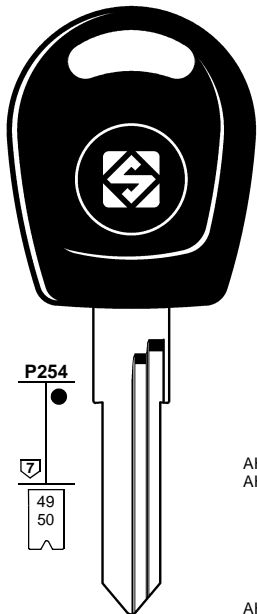

P254  
49  
50

**HU70T6**  
AH ..... 1-8154  
AH ..... 1001-9282

**HU49T28**  
AH ..... 1-8154  
AH ..... 1001-9282

**HU49T5**  
AH ..... 1-8154  
AH ..... 1001-9282

**HU49T10**  
AH ..... 1-8154  
AH ..... 1001-9282

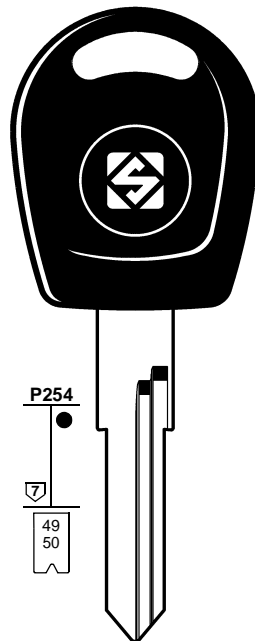

P254  
49  
50

**HU49T10X**  
AH ..... 1-8154  
AH ..... 1001-9282

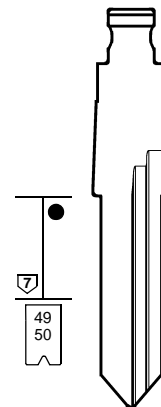

49  
50

**HU49FH**  
AH ..... 1-8154  
AH ..... 1001-9282

WITTE



FOR:  
PER:

# VOLKSWAGEN SUD AMERICA

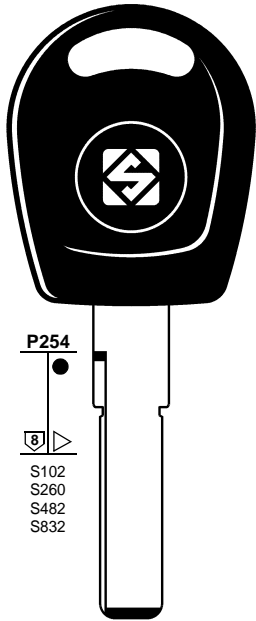

P254  
S102  
S260  
S482  
S832



**HU66T6**

1ATS ..... 00001-17850  
..... 1-2000  
..... 1-6000



**HU66T24**

1ATS ..... 00001-17850  
..... 1-2000  
..... 1-6000

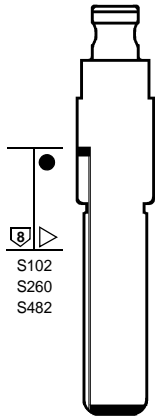

P254  
S102  
S260  
S482



**HU66FH**

..... 1-2000  
..... 0001-6000

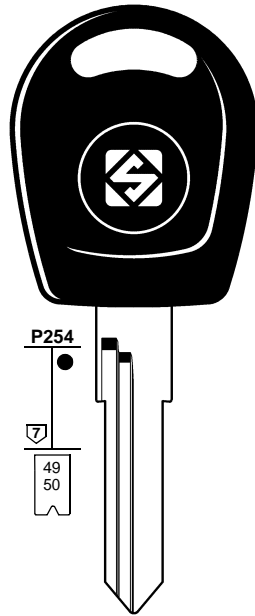

P254  
49  
50



**HU49RT6**

AH ..... 1001-9282

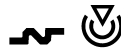

**HU70T6**

AH ..... 1-8154  
AH ..... 1001-9282

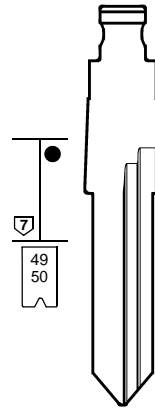

P302  
49  
50



**HU49FH**

AH ..... 1-8154  
AH ..... 1001-9282

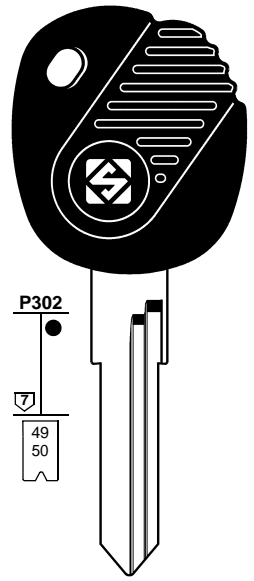

P302  
49  
50



**HU49EP**

AH ..... 1-8154  
AH ..... 1001-9282



**HU49REP**

AH ..... 1-8154  
AH ..... 1001-9282



**HU70EP**

AH ..... 1-8154  
AH ..... 1001-9282

WITTE

FOR:  
PER:

# VOLKSWAGEN SUD AMERICA

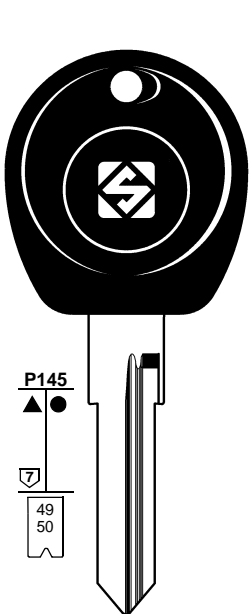

P145  
49  
50

**WT7CP**

HV ..... 1-8154  
HV ..... 1001-9282

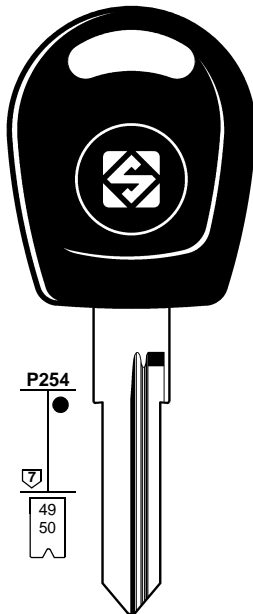

P254  
49  
50

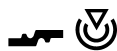

**HV9T6**

HV ..... 1-8154  
HV ..... 1001-9282

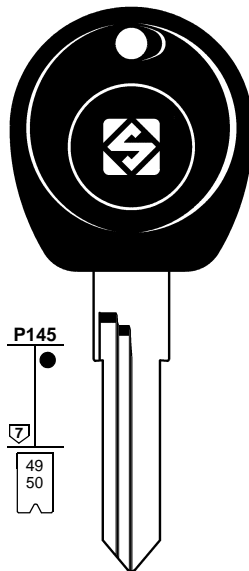

P145  
49  
50

**HU49RCP**

AH ..... 1-8154  
AH ..... 1001-9282

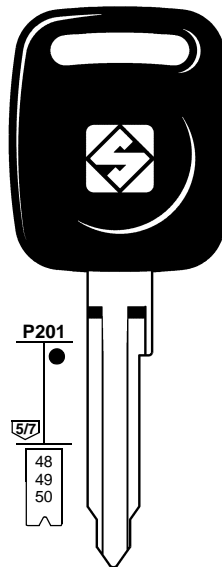

P201  
48  
49  
50

**VO4RDP**

AH ..... 1-8154  
AH ..... 1001-9282  
.. K.. 11-72.1-110

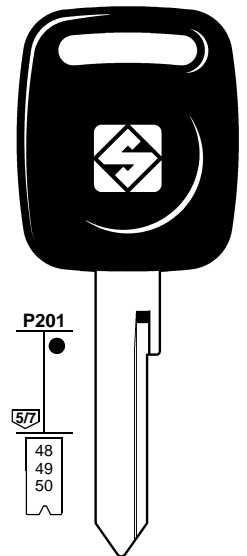

P201  
48  
49  
50

**VO11DP**

AH ..... 1-8154  
AH ..... 1001-9282  
.. R.. 11-72.1-110





FOR:  
PER:

# VOLVO

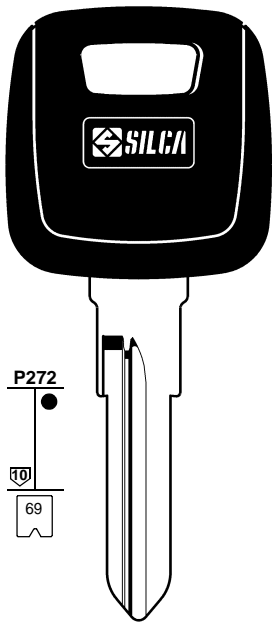

**NE51T2**

1A-2A-3A-4A . . . 000-999  
1B-2B-3B-4B . . . 000-999  
5A-5B . . . 000-746

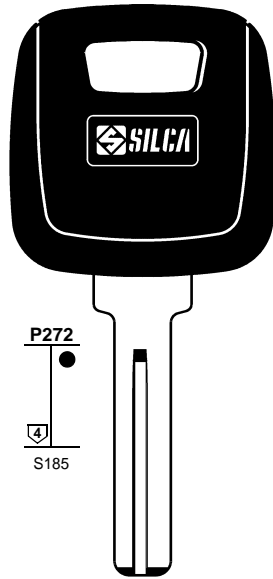

**NE66T2**

1/2/3/4/5V . . . . .  
1-12295

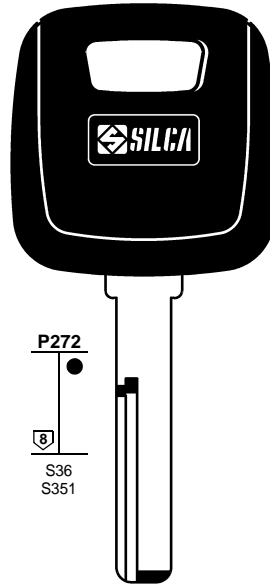

**HU56RAT2**

DH . . . . 6001-8000

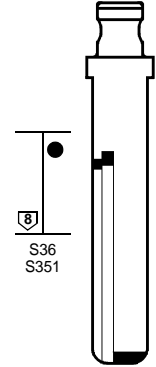

**HU56RFH**

DH . . . . 6001-8000

FOR:  
PER:

# VOLVO

# ZAZ



**HU137KP**

The HU137KP key can be also purchased in 5-piece packages.

*La chiave HU137KP può essere acquistata anche in confezioni da 5 pezzi.*

*Der Schlüssel HU137KP kann auch in Packungen mit 5 Stücken gekauft werden.*

*La clé HU137KP peut même être commandée sous confection de 5 pcs.*

*La llave HU137KP se puede comprar en paquetes de 5 piezas.*

*As chave HU137KP podem ser compradas em pacotes de 5 unidades.*

**HU137TEK**   
(old HU137MHK Reference)

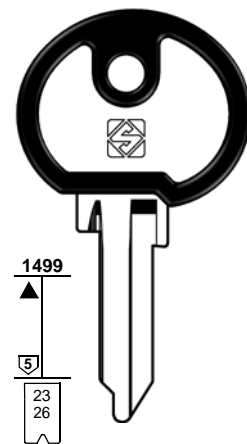

**NE20NP**

. . . . . A/Z 04689  
. . . . . A/Z 12357  
A/Z . . . . . 12357  
A/Z . . . . . A/Z 12357

1	2	2a	3	3a	3b	e1+e2	6	42+71	72	43+44a	12	15	
						<b>GTI COMPATIBLE</b>	<b>IGNITION</b> 						
<b>CAR MAKE MODEL</b>	FROM	TO	SILCA REF.	SILCA REF.	SILCA REF.	COPY	GEN.	TRANSP. TYPE	FAST COPY PLUS RW4 PLUS FAST COPY/RW4	FAST COPY PLUS RW4 PLUS	FAST COPY RW4	STP	
For more info on the uses of car keys, refer to the Silca Electronic Keys Catalogue:													
<b>VOLVO</b>													
C70	1997	1998	NE66T2					PH	73	Y	Y		
C70	1998							PH / CR	4M				
POLAR	1996		NE51T2					PH	73	Y	Y		
S40	1996	1998	HU56RAT2		HU56RFH			PH	73	Y	Y		
S40	1998	2004						PH / CR	4M				
S60	2000							MEG / CR	48				
S70	1997	1998	NE66T2					PH	73	Y	Y		
S70	1998							PH / CR	4M				
S80	1998	1999						PH / CR	4M				
S80	1999	2007						MEG / CR	48				
S80	2008	2011	HU137MHK					PH / CR2	46	Y	P-BOX		
S80	2008	2011	HU137TEK					PH / CR2	46	Y	P-BOX		
V40	1996	1998	HU56RAT2		HU56RFH			PH	73	Y	Y		
V40	1998	2004						PH / CR	4M				
V50	2004							MEG / CR	48				
V70	1997	1998	NE66T2					PH	73	Y	Y		
V70	1998	2000						PH / CR	4M				
V70	2000	2007						MEG / CR	48				
V70	2008		HU137MHK					PH / CR2	46	Y	P-BOX		
V70	2008		HU137TEK					PH / CR2	46	Y	P-BOX		
XC70	2003	2007						MEG / CR	48				
XC70	2008	2011	HU137MHK					PH / CR2	46	Y	P-BOX		
XC70	2008	2011	HU137TEK					PH / CR2	46	Y	P-BOX		
XC90	2003							MEG / CR	48				
850	1996	1997	NE66T2					PH	73	Y	Y		
940	1996	1998	NE51T2					PH	73	Y	Y		
960	1996	1998	NE66T2					PH	73	Y	Y		
<b>ZAZ</b>													
SOME MODELS	1995		NE20NP										



Motorcycle keys guide  
Guida chiavi moto  
Marktführer für Motorräderschlüssel  
Guide clés pour motocyclettes  
Guía llaves para motocicletas  
Guia chaves para motocicletas

FOR:  
PER:

# APRILIA

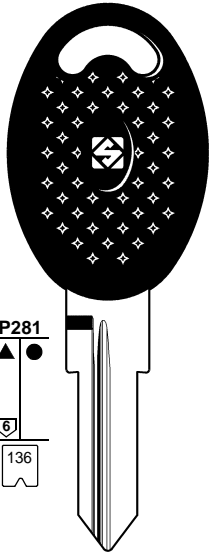

**TL**  
ZD22RBP

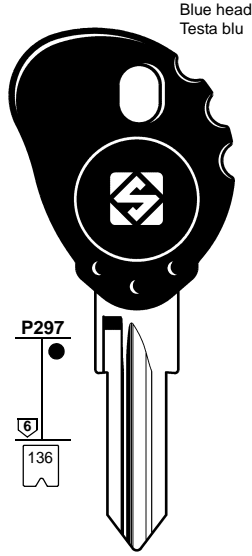

**TL**   
ZD23RT5  
... 8001-9554

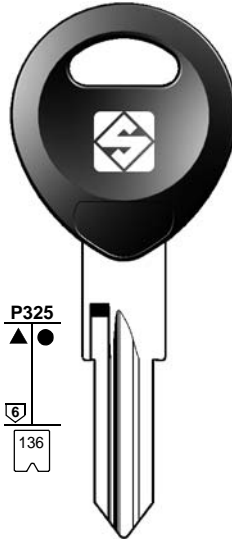

**TL**  
ZD24RDP  
... 8001-9554  
... 1001-2252  
N ... 1-700  
... 1-700  
... 1234

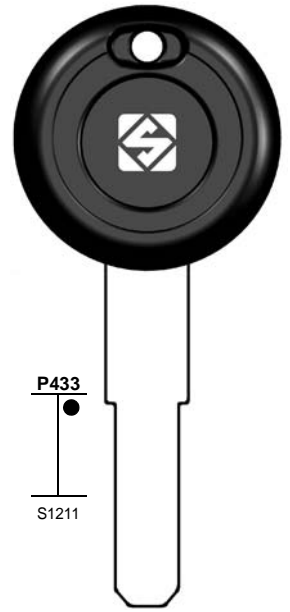

**TL**   
ZD30T5  
Z ... 2001-9416

FOR:  
PER:

# ATALA

# BAJAJ

# BETA

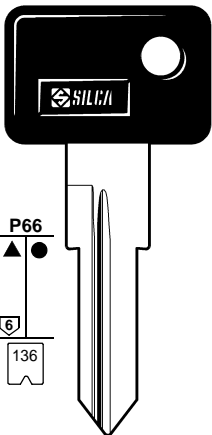

**TL**  
ZD16RP  
... 8001-9554  
N ... 1-700  
... 1-700

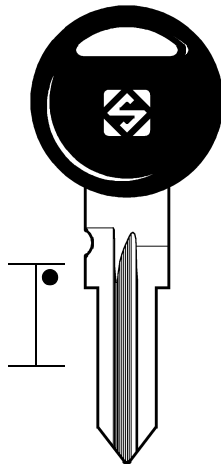

**TL**  
BAJ1RP

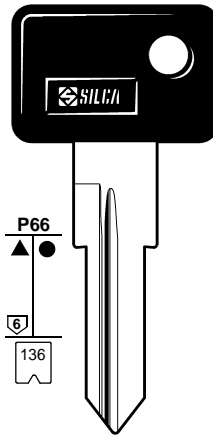



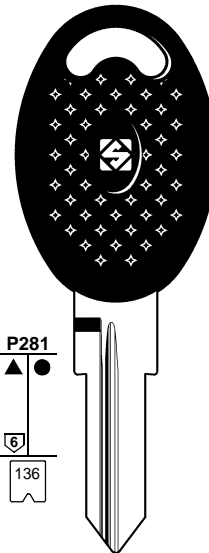



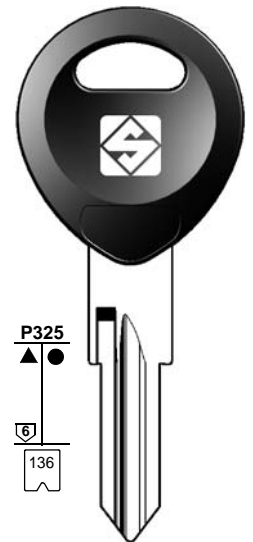









**TL**  
ZD16RP  
... 8001-9554  
N ... 1-700  
... 1-700



**TL**  
ZD22RBP



**TL**  
ZD24RDP  
... 8001-9554  
... 1001-2252  
N ... 1-700  
... 1-700  
... 1234

1	2	2a	3	3a	3b	e1+e2	6	42+71	72	43+44a	12	15	
						GTI COMPATIBLE	IGNITION 						
MOTORCYCLE MAKE MODEL	FROM	TO	SILCA REF.	SILCA REF.	SILCA REF.	COPY	GEN.	TRANSP. TYPE	FAST COPY PLUS RW4 PLUS FAST COPY/RW4	FAST COPY PLUS RW4 PLUS	FAST COPY RW4	STP	
													
For more info on the uses of motorcycle keys, refer to the Silca Electronic Keys Catalogue: 													
<b>APRILIA</b>													
AMICO	1996	1998	ZD22RBP										
AREA 51	1998	2000	ZD22RBP										
ATLANTIC	2003		ZD24RDP										
ATLANTIC 500	2001		ZD23RT5					TEMIC	12	Y	Y		
CLASSIC 125	1996	1999	ZD22RBP										
CLASSIC 50	1996	1999	ZD22RBP										
DORSODURO	2008		ZD23RT5					TEMIC	12	Y	Y		
ETV 1000 CAPONORD	2001	2007	ZD22RBP										
GULLIVER	1995	1998	ZD22RBP										
LEONARDO	1996	2004	ZD22RBP										
MANA 850	2007		ZD23RT5					TEMIC	12	Y	Y		
MOJITO	1999	2008	ZD22RBP										
MOTÒ 6.5	1996	2002	ZD22RBP										
MX	2002	2006	ZD22RBP										
PEGASO	1997	2004	ZD22RBP										
PEGASO	2005	2007	ZD23RT5					TEMIC	12	Y	Y		
RALLY	1996	2004	ZD22RBP										
RS	1996	2005	ZD22RBP										
RST FUTURA	2000	2003	ZD22RBP										
RSV SERIES	2009		ZD30T5					TEMIC	12	Y	Y		
RSV 1000	1998	2005	ZD22RBP										
RSV 1000	2004	2008	ZD30T5					TEMIC	12	Y	Y		
RX 50	1996	2004	ZD22RBP										
SCARABEO	1993		ZD22RBP										
SCARABEO 500	2001		ZD23RT5					TEMIC	12	Y	Y		
SHIVER	2007		ZD23RT5					TEMIC	12	Y	Y		
SL 1000 FALCO	2000	2003	ZD22RBP										
SONIC 50	1998	2008	ZD22RBP										
SPORTCITY	2004		ZD22RBP										
SR 125 - 150	1999	2001	ZD22RBP										
SR 50	1996	2004	ZD22RBP										
SR 50	2004		ZD23RT5					TEMIC	12	Y	Y		
TUONO 1000R	2004		ZD30T5					TEMIC	12	Y	Y		
<b>ATALA</b>													
BYTE AT10-50	1996		ZD16RP										
GREEN	1996		ZD16RP										
HACKER-AT12	1996		ZD16RP										
<b>BAJAJ</b>													
SOME MODELS	2009		BAJ1RP										
<b>BETA</b>													
ALP			ZD24RDP										
CHRONO	1995	1996	ZD16RP										
CHRONO 502	1995	1996	ZD16RP										
QUADRA	1995	1996	ZD16RP										
QUADRA	1996		ZD22RBP										
RR	2005		ZD24RDP										
TEMPO	1995	1996	ZD16RP										
TEMPO	1996		ZD22RBP										
SOME MODELS	1996		ZD22RBP										

FOR:  
PER:

# BMW

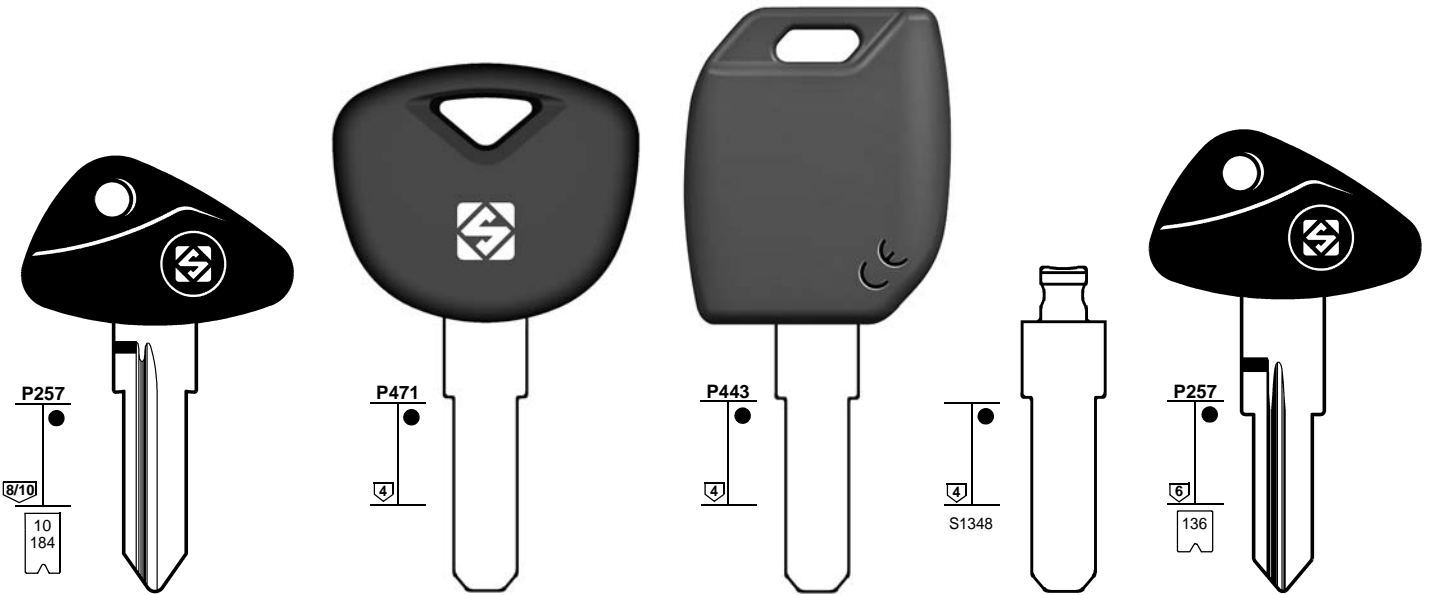

**BW7BP**

HB . . . . 1-5000  
H . . . . P 12353-53425  
H . . . . P 12353-53412



**BW9TE**



**BW9MH**



**BW9FH**

K . . . . 5001-8276



**ZD28RFP**

. . . . 8001-9554

FOR:  
PER:

# BUELL

# CAGIVA

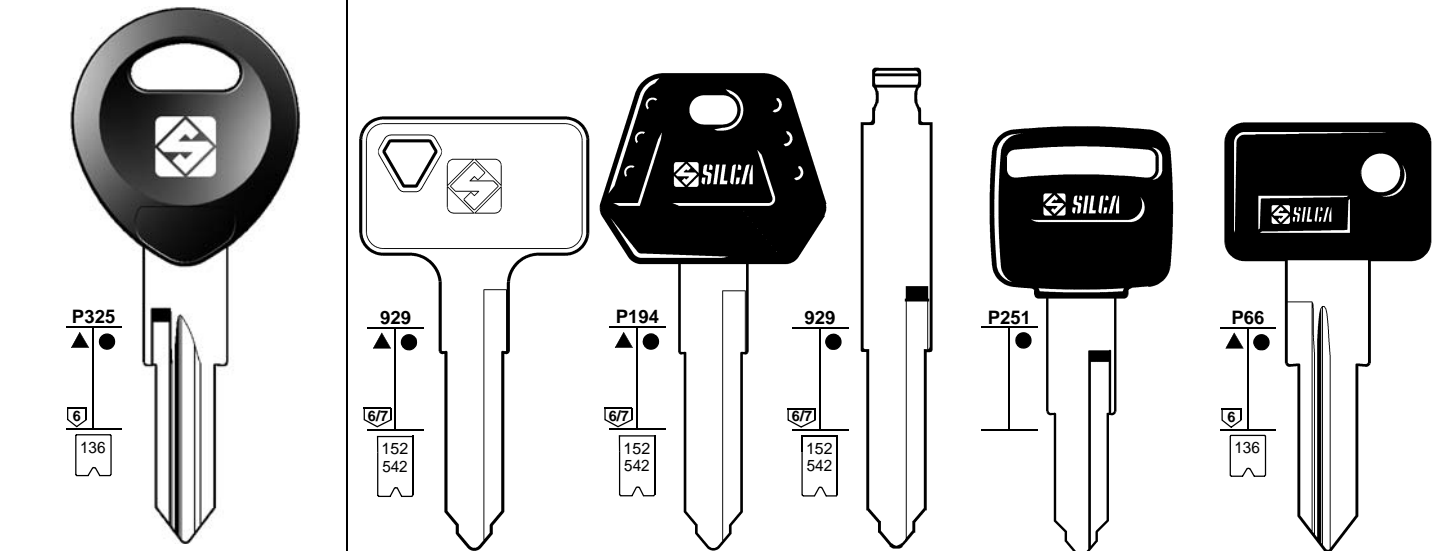

**ZD24RDP**

. . . . 8001-9554  
. . . . 1001-2252  
N . . . . 1-700  
. . . . 1-700  
. . . . 1234

**KW14**

B . . . . 1234  
H . . . . 1234  
B . . . . 8001-9000  
H . . . . 8001-9000

**KW14P**

. . . . 8001-9000  
B . . . . 1234  
H . . . . 1234  
B . . . . 8001-9000



**KW14FH**

B . . . . 8001-9000

**ZD21P**



**ZD16RP**

. . . . 8001-9554  
. . . . 1-700  
. . . . 1-700



FOR:  
PER:

# CAGIVA

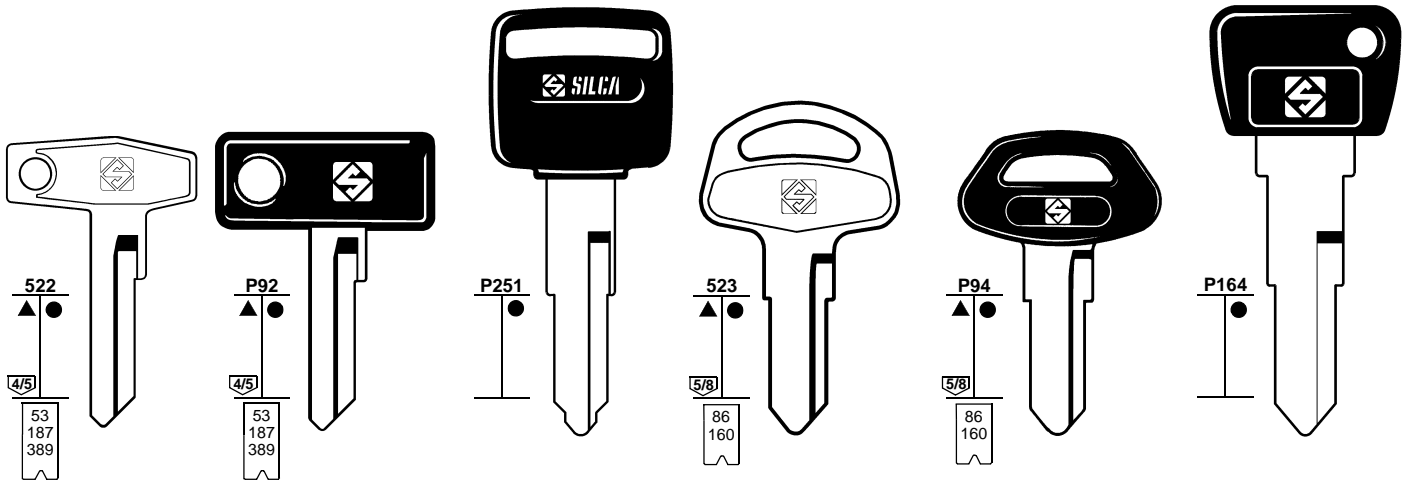

**ZD9**  
E... 1-500  
E... 501-710  
... 1-1625  
... 9001-9500  
... 5001-6278

**ZD9P**  
E... 1-500  
E... 501-710  
... 1-1625  
... 9001-9500  
... 5001-6278

**ZD21P**

**SZ4**  
A... 00-99  
... 101-499  
... 751-795

**SZ4AP**  
A... 00-99  
... 101-499  
... 751-795

**CG1P**

**CG2RP**

FOR:  
PER:

# DERBI

# DUCATI

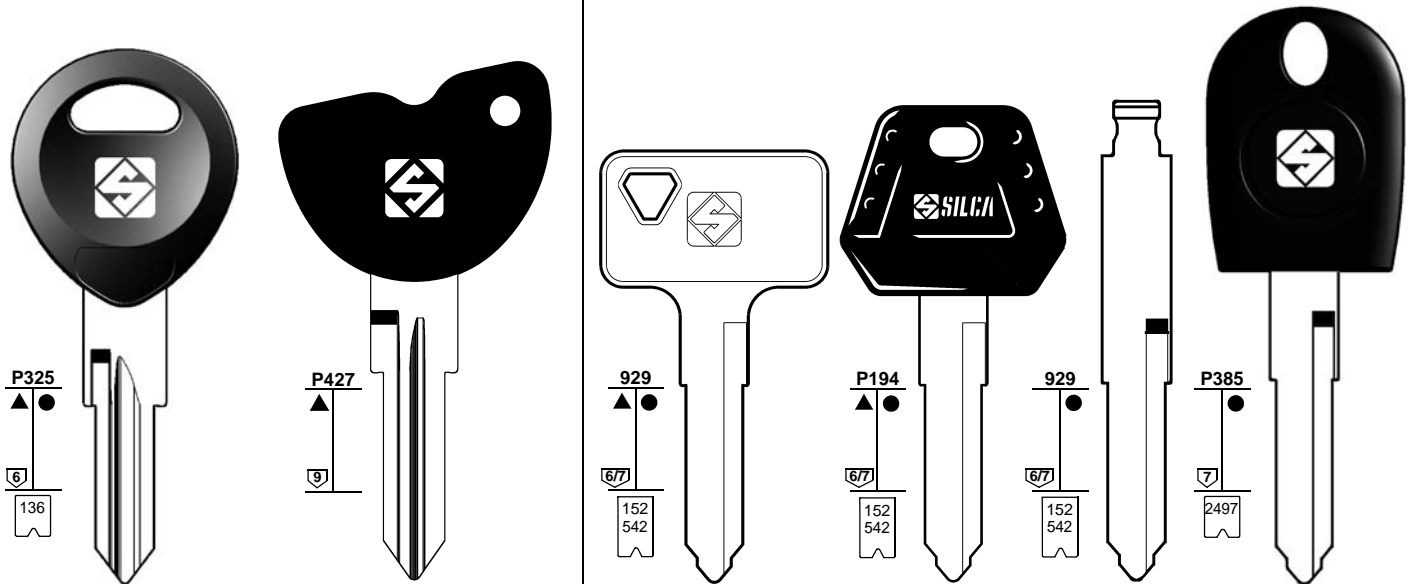

**ZD24RDP**  
... 8001-9554  
... 1001-2252  
N... 1-700  
... 1-700  
... 1234

**GT20RDP**  
W... 1-9640

**KW14**  
B... 1234  
H... 1234  
B... 8001-9000  
H... 8001-9000

**KW14P**  
... 8001-9000  
B... 1234  
H... 1234  
B... 8001-9000

**KW14FH**  
B... 8001-9000

**KW17T5**  
... 1-2-3-4

GIOBERT - TRW SIPEA





FOR:  
PER:

# DUCATI

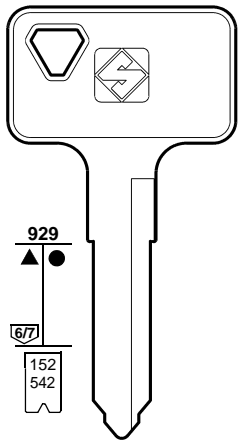

**KW14**

B ..... 1234  
H ..... 1234  
B ..... 8001-9000  
H ..... 8001-9000

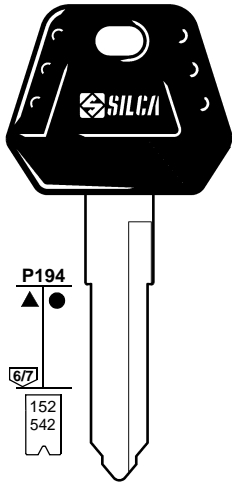

**KW14P**

..... 8001-9000  
B ..... 1234  
H ..... 1234  
B ..... 8001-9000  
H ..... 8001-9000

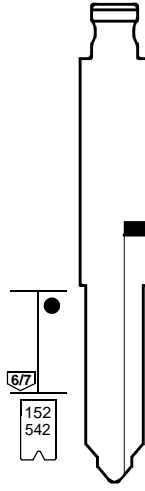

**KW14FH**

B ..... 8001-9000



**KW17T5**

..... 1-2-3-4

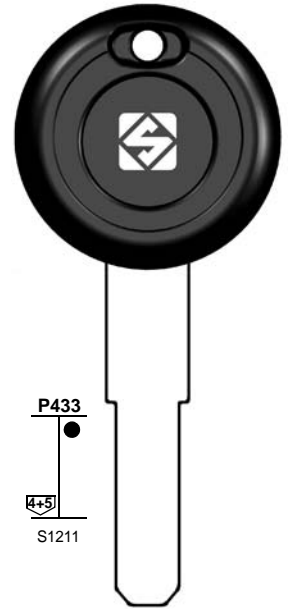

**ZD30T5**

Z ..... 2001-9416

FOR:  
PER:

# GILERA

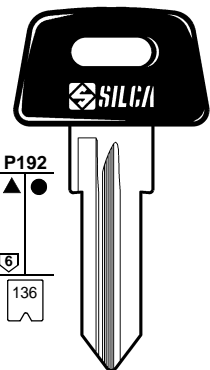

**ZD17RAP**

..... 8001-9554



**ZD24RDP**

..... 8001-9554  
..... 1001-2252  
N ..... 1-700  
... 1-700  
..... 1234

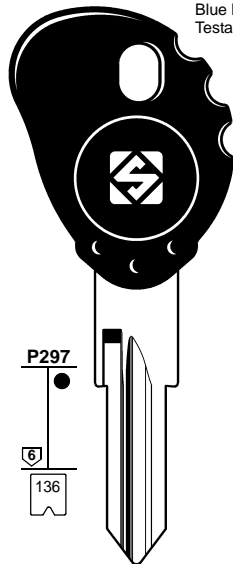

**ZD24RT5**

..... 8001-9554  
..... 1001-2252  
N ..... 1-700  
... 1-700

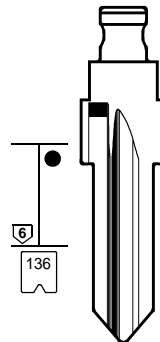

**ZD24RFH**

..... 8001-9554  
..... 1001-2252  
N ..... 1-700  
... 1-700  
..... 1234

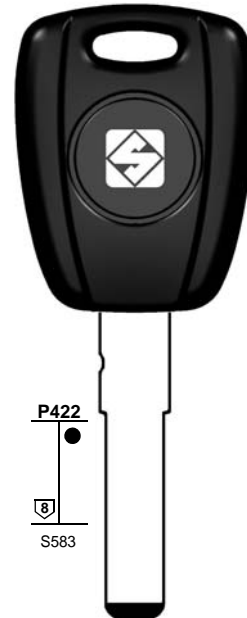

**SIP22T5**

DE ..... 1-11210

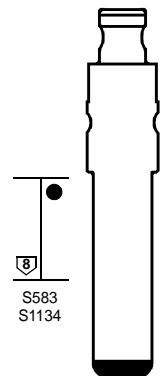

**SIP22FH**

DE ..... 1-11210

Blue head  
Testa blu

1	2	2a	3	3a	3b	e1+e2		6	42+71	72	43+44a	12	15
						GTI COMPATIBLE		IGNITION					
MOTORCYCLE MAKE MODEL	FROM	TO	SILCA REF.	SILCA REF.	SILCA REF.	COPY	GEN.	TRANSP. TYPE	FAST COPY PLUS RW4 PLUS FAST COPY/RW4	FAST COPY PLUS RW4 PLUS	FAST COPY RW4	STP	
For more info on the uses of motorcycle keys, refer to the Silca Electronic Keys Catalogue:													
<b>DUCATI</b>													
MONSTER 1100	2009		ZD30T5					TEMIC	11	Y	Y		S1
MONSTER 600	1994	2001	KW14		KW14FH								
MONSTER 600	1994	2001	KW14P		KW14FH								
MONSTER 620	2002	2006	KW17T5					TEMIC	11	Y	Y		S1
MONSTER 695	2001	2008	KW17T5					TEMIC	11	Y	Y		S1
MONSTER 696	2009		ZD30T5					TEMIC	11	Y	Y		S1
MONSTER 750	2001	2002	KW17T5					TEMIC	11	Y	Y		S1
MONSTER 796	2011		ZD30T5					TEMIC	11	Y	Y		S1
MONSTER 800	2003	2003	KW17T5					TEMIC	11	Y	Y		S1
MONSTER 900	1994	2001	KW14P		KW14FH								
MONSTER 900	2001	2002	KW17T5					TEMIC	11	Y	Y		S1
MULTISTRADA	2010							TEM / CR	8C				
SPORTCLASSIC 1000	2007	2010	KW17T5					TEMIC	11	Y	Y		S1
STREETFIGHTER	2009		ZD30T5					TEMIC	11	Y	Y		S1
ST2	1997	2003	KW14		KW14FH								
ST2	1997	2003	KW14P		KW14FH								
ST3	2005	2007	KW17T5					TEMIC	11	Y	Y		S1
ST4	1998	2003	KW14P		KW14FH								
ST4	1998	2003	KW14		KW14FH								
ST4	2002	2005	KW17T5					TEMIC	11	Y	Y		S1
SUPERSPORT 1000	2003	2006	KW17T5					TEMIC	11	Y	Y		S1
SUPERSPORT 620	2003	2006	KW17T5					TEMIC	11	Y	Y		S1
SUPERSPORT 750	1999	2003	KW14P		KW14FH								
SUPERSPORT 750	1999	2003	KW14		KW14FH								
SUPERSPORT 800	2003	2006	KW17T5					TEMIC	11	Y	Y		S1
SUPERSPORT 900	1998	2002	KW14		KW14FH								
SUPERSPORT 900	1998	2002	KW14P		KW14FH								
<b>GILERA</b>													
FUOCO	2006		SIP22T5		SIP22FH			TEMIC	11	Y	Y	T-F	S9
GP800	2006		SIP22T5		SIP22FH			TEMIC	11	Y	Y	T-F	S9
NCR 50	2006		ZD24RDP										
NEXUS	2006		ZD24RDP										
NEXUS 250	2006	2008	ZD24RT5		ZD24RFH			TEMIC	11	Y	Y	T-F	S9
NEXUS 300	2007		ZD24RT5		ZD24RFH			TEMIC	11	Y	Y		S9
NEXUS 500	2006	2012	SIP22T5		SIP22FH			TEMIC	11	Y	Y	T-F	S9
RUNNER	2006		ZD24RDP										
STORM 50	1995		ZD17RAP										
TYPHOON	1995	2001	ZD17RAP										
SOME MODELS	1995		ZD17RAP										

FOR: HARLEY DAVIDSON HM HONDA  
 PER:

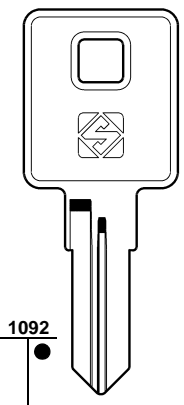

1092  
 1025

**HY11R**

GY ..... 1-2-3-4-5  
 BZ ..... 1-2-3-4-5  
 C ..... 1-2-3-4-5  
 A ..... 1-2-3-4-5

439

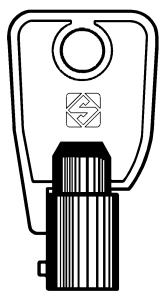

S249  
 S311  
 S345  
 S346  
 S347  
 S445  
 S446  
 S549  
 S550  
 S757  
 S759  
 S989  
 S1335  
 S1334  
 S1148  
 S1147  
 S1146

**CH9T**

..... 7654321  
 ..... 7654321  
 ..... 320001-326000  
 ..... 280001-285000  
 .... 2001-2100  
 .... 1234567  
 HD..... 0001-9400  
 ....HD 0001-9400  
 ..... 7654321  
 ... 1-999  
 ..... 0123  
 .....  
 24568ABCDEFGHIJKLMNO  
 ..... 01234567  
 HMC..... 00001-31000



P325  
 136

**ZD24RDP**

.... 8001-9554  
 .... 1001-2252  
 N ... 1-700  
 ... 1-700  
 ..... 1234



P431  
 148  
 262

**HON70T14**

..... 1-2-3  
 .... 5001-8442

**HON70TE**

AH ..... 1001-9282  
 AH ..... 1-8154  
 (head code P459)



P443  
 148  
 262

**HON70MH**

..... 1-2-3  
 .... 5001-8442

FOR: HONDA  
 PER:

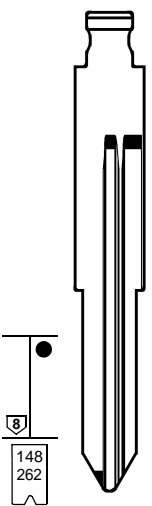

148  
 262

**HON70FH**

..... 1-2-3  
 .... 5001-8442



P321  
 148

**HON63FP**

..... 1-2-3

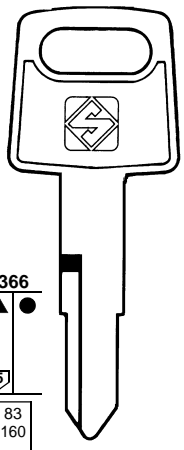

366  
 83  
 160

**HON31**

... 121-140  
 ... 521-540  
 ... 621-640  
 ... 721-740  
 ... 821-840  
 ... 221-240  
 ... 421-440  
 ... 321-340  
 C .. 00-99  
 D .. 00-99

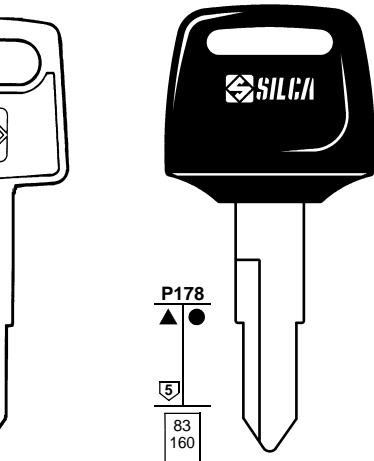

P178  
 83  
 160

**HON31R**

A .. 00-99  
 B .. 00-99  
 ... 101-120  
 ... 201-220  
 ... 301-320  
 ... 401-420  
 ... 501-520  
 ... 701-720  
 ... 601-620  
 ... 801-820

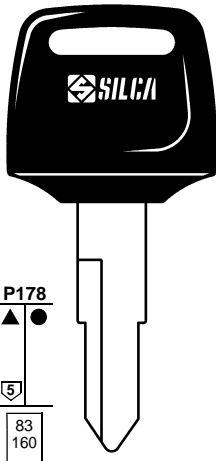

P178

**HON31CP**

... 121-140  
 ... 521-540  
 ... 621-640  
 ... 721-740  
 ... 821-840  
 ... 221-240  
 ... 421-440  
 ... 321-340  
 C .. 00-99  
 D .. 00-99

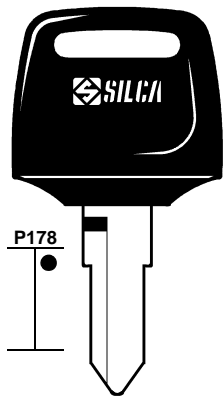

**HON71CP**



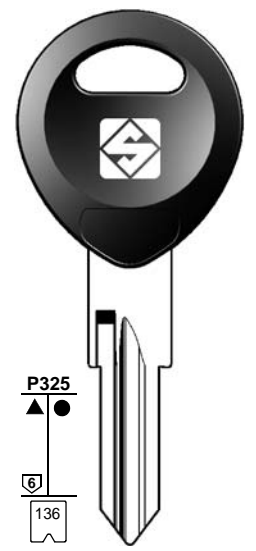













**HON71RCP**



P325  
 136

**ZD24RDP**

.... 8001-9554  
 .... 1001-2252  
 N ... 1-700  
 ... 1-700  
 ..... 1234

1	2	2a	3	3a	3b	e1+e2		6	42+71	72	43+44a	12	15
						GTI COMPATIBLE		IGNITION 					
MOTORCYCLE MAKE MODEL	FROM	TO	SILCA REF.	SILCA REF.	SILCA REF.	COPY	GEN.	TRANSP. TYPE	FAST COPY PLUS RW4 PLUS FAST COPY/RW4	FAST COPY PLUS RW4 PLUS	FAST COPY RW4	STP	
													
For more info on the uses of motorcycle keys, refer to the Silca Electronic Keys Catalogue: 													
<b>HARLEY DAVIDSON</b>													
1200 SPORTSTER	1994		HY11R										
883 SPORTSTER	1994		HY11R										
SOME MODELS	1996		CH9T										
<b>HM</b>													
LOCUSTA			ZD24RDP										
<b>HONDA</b>													
BLACK SPIRIT	2010		HON70T14					PH / CR2	46				
BLACK SPIRIT	2010		HON70MH	HON70TE	HON70FH	Y	Y	PH / CR2	46	Y	P-BOX		
CBF500	2004	2007	HON63FP										
CBF600	2004	2007	HON63FP										
CBF600	2007	2012	HON70T14					PH / CR2	46				
CBF600	2007	2012	HON70MH	HON70TE	HON70FH	Y	Y	PH / CR2	46	Y	P-BOX		
CBR1000	2004		HON70T14					PH / CR2	46				
CBR1000	2004		HON70MH	HON70TE	HON70FH	Y	Y	PH / CR2	46	Y	P-BOX		
CBR1000F	1997	1999	HON63FP										
CBR1100XX	1999	2006	HON70T14					PH / CR2	46				
CBR1100XX	1999	2006	HON70MH	HON70TE	HON70FH	Y	Y	PH / CR2	46	Y	P-BOX		
CBR600F	1999	2006	HON70T14					PH / CR2	46				
CBR600F	1999	2006	HON70MH	HON70TE	HON70FH	Y	Y	PH / CR2	46	Y	P-BOX		
CBR600RR	2003		HON70T14					PH / CR2	46				
CBR600RR	2003		HON70MH	HON70TE	HON70FH	Y	Y	PH / CR2	46	Y	P-BOX		
CBR900	2003		HON70T14					PH / CR2	46				
CBR900	2003		HON70MH	HON70TE	HON70FH	Y	Y	PH / CR2	46	Y	P-BOX		
CBR900RR	1994	1997	HON31										
CBR900RR	1994	1997	HON31R										
CBR900RR	1994	1997	HON31CP										
CBR900RR	1994	1997	HON31RCP										
CBR900RR	1997	2003	HON63FP										
CB500	1994	1997	HON31										
CB500	1994	1997	HON31R										
CB500	1994	1997	HON31RCP										
CB500	1994	1997	HON31CP										
CB500S	1997	2003	HON63FP										
CG125	1993	2008	HON71RCP										
CROSSRUNNER	2011		HON70T14					PH / CR2	46				
CROSSRUNNER	2011		HON70MH	HON70TE	HON70FH	Y	Y	PH / CR2	46	Y	P-BOX		
CROSSTOURER	2012		HON70T14					PH / CR2	46				
CROSSTOURER	2012		HON70MH	HON70TE	HON70FH	Y	Y	PH / CR2	46	Y	P-BOX		
CTX1300	2014		HON70T14					PH / CR2	46				
CTX1300	2014		HON70MH	HON70TE	HON70FH	Y	Y	PH / CR2	46	Y	P-BOX		
CTX700	2014		HON70T14					PH / CR2	46				
CTX700	2014		HON70MH	HON70TE	HON70FH	Y	Y	PH / CR2	46	Y	P-BOX		
C90 ECO PWR	1993		HON71CP										
DYLAN 125	2004		ZD24RDP										
FORZA	2005		HON63FP										
GOLD WING	2001							PH / CR2	46				

FOR:  
PER:

# HONDA

Technical diagrams for seven Honda key models, showing key profiles and head shapes. Each diagram includes a model name, a key type icon (TE, MH, FH, or standard), and a list of applicable part numbers.

- HON58RTE** (TE KEY): P475, 262. Part numbers: 5001-8442.
- HON58RMH** (MH KEY): P443, 262. Part numbers: 5001-8442.
- HON58RFH** (FH FLIP): P443, 262, 514. Part numbers: 5001-8442, 10001-15000.
- HON63FP**: P321, 148. Part numbers: 1-2-3.
- HON64BP**: P61, 160. Part numbers: 00-A99.
- HON64**: 1449, 160. Part numbers: 00-A99.
- HON41**: 554, 148. Part numbers: 123, J00-U39.
- HON64RBP**: 160. Part numbers: 00-A99.





















FOR:  
PER:

# HONDA

Technical diagrams for seven Honda key models, showing key profiles and head shapes. Each diagram includes a model name, a key type icon (TE, MH, FH, or standard), and a list of applicable part numbers. A note 'Blue head Testa blu' is present near the HON41P model.

- HON41P**: 554, 148. Part numbers: 123, J00-U39.
- HON70T14**: P431, 148, 262. Part numbers: 1-2-3, 5001-8442.
- HON70MH**: P443, 148, 262. Part numbers: 1-2-3, 5001-8442.
- HON70FH**: P443, 148, 262. Part numbers: 1-2-3, 5001-8442.
- ZD24RDP**: P325, 136. Part numbers: 8001-9554, 1001-2252, N... 1-700, ... 1-700, ... 1234.
- ZD24RT14**: P297, 136. Part numbers: 8001-9554, 1001-2252, N... 1-700, ... 1-700.
- HON70TE** (TE KEY): P459. Part numbers: AH... 1001-9282, AH... 1-8154.

Blue head  
Testa blu

1	2	2a	3	3a	3b	e1+e2		6	42+71	72	43+44a	12	15
						GTI COMPATIBLE		IGNITION   					
MOTORCYCLE MAKE MODEL	FROM	TO	SILCA REF.	SILCA REF.	SILCA REF.	COPY	GEN.	TRANSP. TYPE	FAST COPY PLUS RW4 PLUS FAST COPY/RW4	FAST COPY PLUS RW4 PLUS	FAST COPY RW4	STP	
													
For more info on the uses of motorcycle keys, refer to the Silca Electronic Keys Catalogue:    													
HONDA													
GOLD WING	2001		HON58RMH	HON58RTE	HON58RFH	Y	Y	PH / CR2	46	Y	P-BOX		
HORNET	1998	2002	HON64										
HORNET	1998	2002	HON64BP										
HORNET	1998	2002	HON64RBP										
HORNET	2003		HON70T14					PH / CR2	46				
HORNET	2003		HON70MH	HON70TE	HON70FH	Y	Y	PH / CR2	46	Y	P-BOX		
INTEGRA	2012		HON70T14					PH / CR2	46				
INTEGRA	2012		HON70MH	HON70TE	HON70FH	Y	Y	PH / CR2	46	Y	P-BOX		
LEAD 100	2003	2007	HON41										
LEAD 100	2003	2007	HON41P										
NC700 S	2012		HON70T14					PH / CR2	46				
NC700 S	2012		HON70MH	HON70TE	HON70FH	Y	Y	PH / CR2	46	Y	P-BOX		
NC700 X	2012		HON70T14					PH / CR2	46				
NC700 X	2012		HON70MH	HON70TE	HON70FH	Y	Y	PH / CR2	46	Y	P-BOX		
NC750	2014		HON70T14					PH / CR2	46				
NC750	2014		HON70MH	HON70TE	HON70FH	Y	Y	PH / CR2	46	Y	P-BOX		
NTV650	1997	1998	HON63FP										
NT650V	1999	2006	HON70T14					PH / CR2	46				
NT650V	1999	2006	HON70MH	HON70TE	HON70FH	Y	Y	PH / CR2	46	Y	P-BOX		
NT700V	2006	2012	HON70T14					PH / CR2	46				
NT700V	2006	2012	HON70MH	HON70TE	HON70FH	Y	Y	PH / CR2	46	Y	P-BOX		
NX650	1997	2000	HON63FP										
PHANTEON	2003		ZD24RDP										
PS125i	2006		ZD24RDP										
PS150i	2006		ZD24RDP										
SFX50	1994	1997	HON41P										
SFX50	1994	1997	HON41										
SFX50	1997	2004	HON63FP										
SHADOW 750	2004		HON70T14					PH / CR2	46				
SHADOW 750	2004		HON70MH	HON70TE	HON70FH	Y	Y	PH / CR2	46	Y	P-BOX		
SH100	1997	2001	HON63FP										
SH125i	2005		ZD24RDP										
SH150i	2006		ZD24RDP										
SH300	2007		ZD24RT14					PH / CR2	46				

FOR:  
PER:

# HONDA

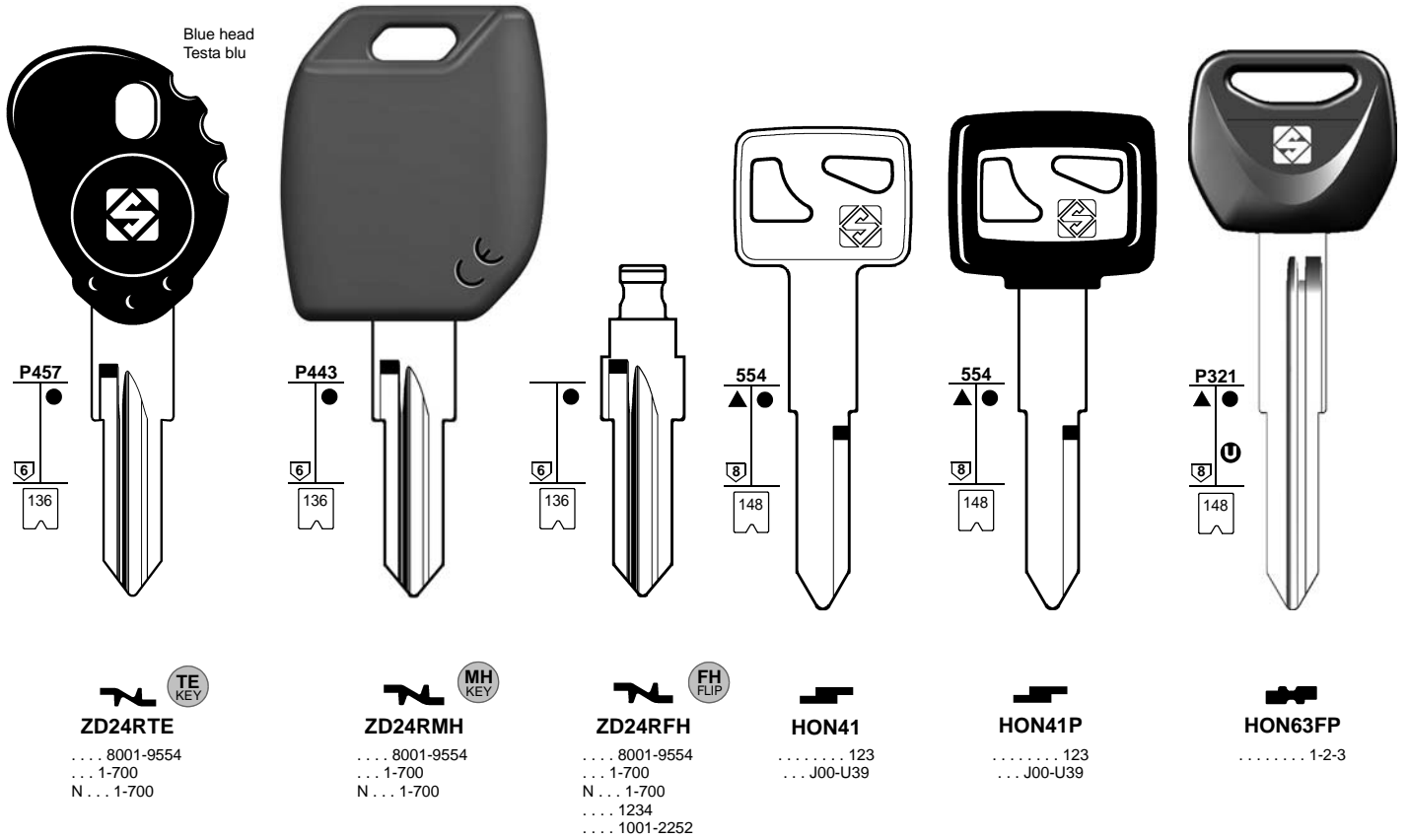

FOR:  
PER:

# HONDA

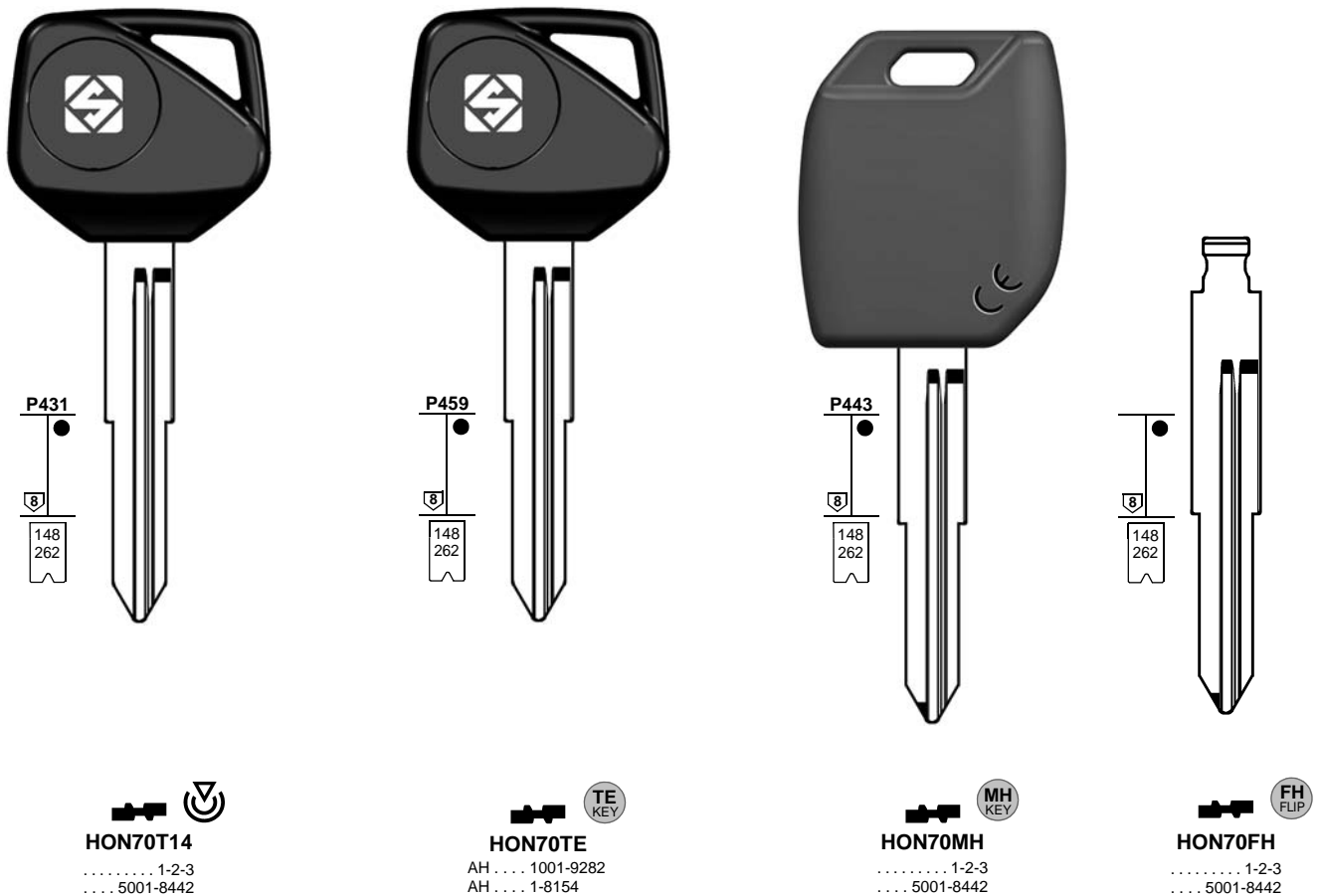





FOR:  
PER:

# HONDA

**HON64BP**  
A... 00-A99

**HON64R**  
A... 00-A99

**HON72P**

**HON68BP**  
A... 00-99  
B... 00-99

**HON70T14**  
..... 1-2-3  
..... 5001-8442

**HON70MH**  
..... 1-2-3  
..... 5001-8442

**HON64RBP**  
A... 00-A99

**HON68RBP**  
C... 00-99  
B... 00-99

**HON70TE**  
AH... 1001-9282  
AH... 1-8154  
(head code P459)

FOR:  
PER:

# HONDA

# ITALJET

**HON70FH**  
..... 1-2-3  
..... 5001-8442

**HON31**  
... 121-140  
... 521-540  
... 621-640  
... 721-740  
... 821-840  
... 221-240  
... 421-440  
... 321-340  
C... 00-99  
D... 00-99

**HON31R**  
A... 00-99  
B... 00-99  
... 101-120  
... 201-220  
... 301-320  
... 401-420  
... 501-520  
... 701-720  
... 601-620  
... 801-820

**HON31CP**  
... 121-140  
... 521-540  
... 621-640  
... 721-740  
... 821-840  
... 221-240  
... 421-440  
... 321-340  
C... 00-99  
D... 00-99

**HON31RCP**  
A... 00-99  
B... 00-99  
... 101-120  
... 201-220  
... 301-320  
... 401-420  
... 501-520  
... 701-720  
... 601-620  
... 801-820

**ZD23RCP**  
..... 8001-9554

**ZD16RP**  
..... 8001-9554  
... 1-700  
... 1-700

**YH34P**

**YH34RP**



FOR:  
PER:

# KAWASAKI

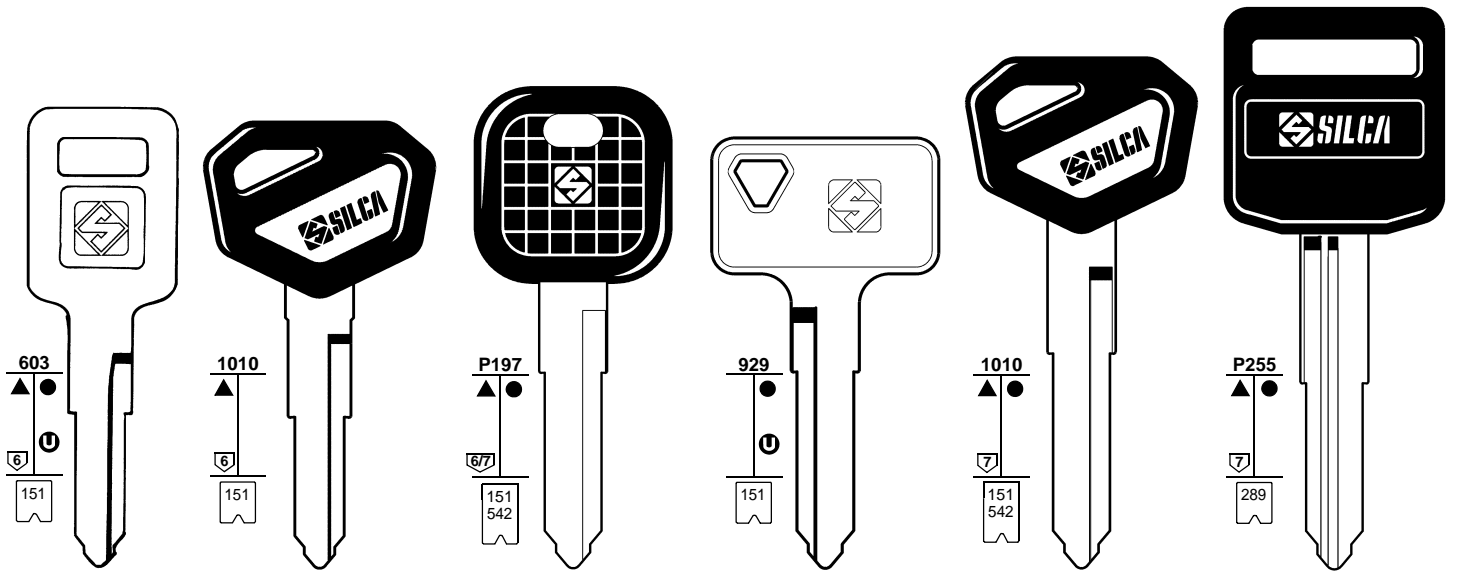

**KW12**  
Z ..... 5001-6000  
Z ..... 5001-6000 (NEW)

**KW12BP**  
Z ..... 5001-6000  
Z ..... 5001-6000 (NEW)

**KW14AP**  
B ..... 1234  
H ..... 1234  
..... 8001-9000  
B ..... 8001-9000

**KW14R**  
B ..... 1234  
H ..... 1234  
..... 8001-9000  
B ..... 8001-9000

**KW15BP**  
B ..... 8001-9000

**SZ14RAP**  
..... 6001-7000  
A ..... 6001-7000

FOR:  
PER:

# KAWASAKI

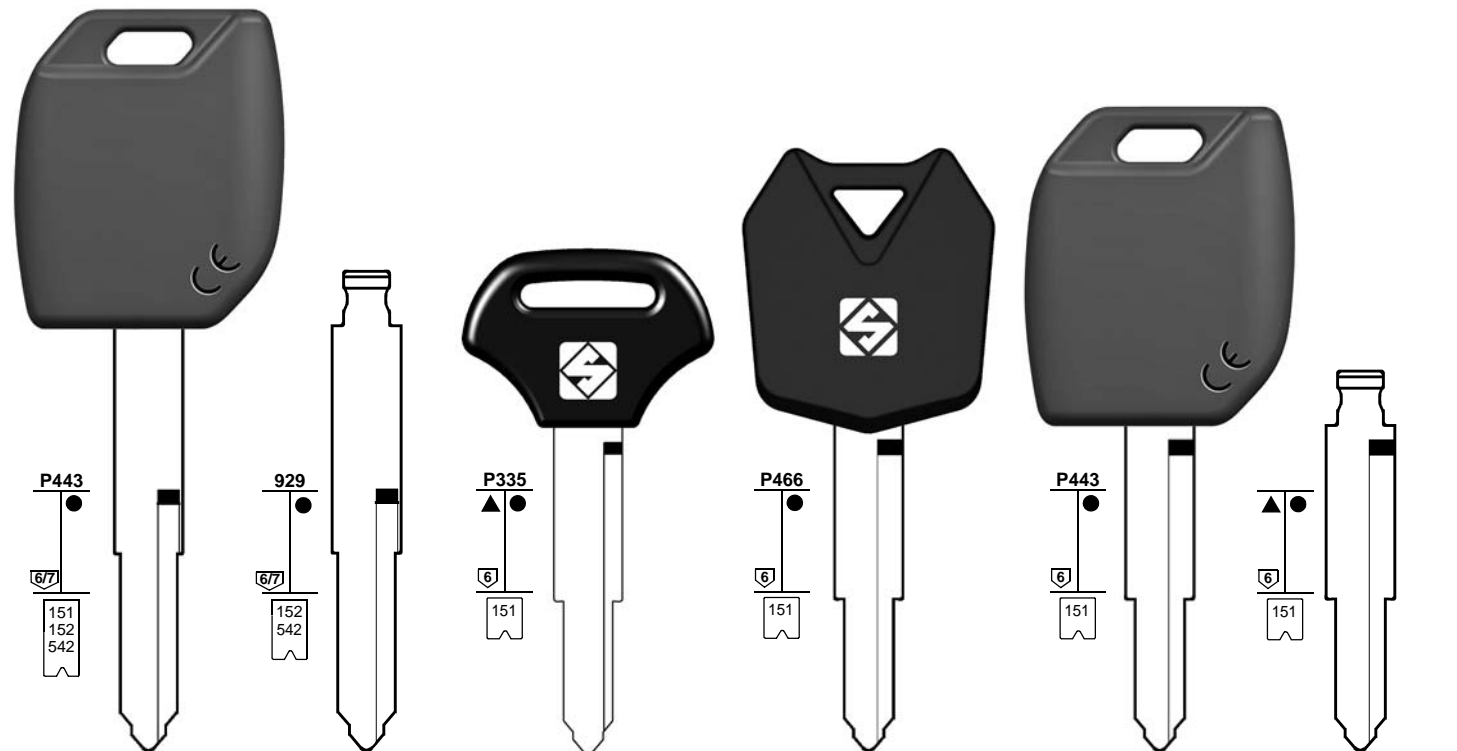

**KW14MH**  
Z ..... 5001-6000  
..... 8001-9000  
B ..... 8001-9000  
B ..... 1234  
H ..... 1234

MH  
KEY

**KW14FH**  
B ..... 8001-9000

FH  
FLIP

**KW16CP**  
Z .....  
5001-6000

**KW16TE**  
Z .....  
5001-6000

TE  
KEY

**KW16MH**  
Z ..... 5001-6000  
Z ..... 5001-6000 (NEW)

MH  
KEY

**KW16FH**  
Z .....  
5001-6000

FH  
FLIP



FOR:  
PER:

# KAWASAKI

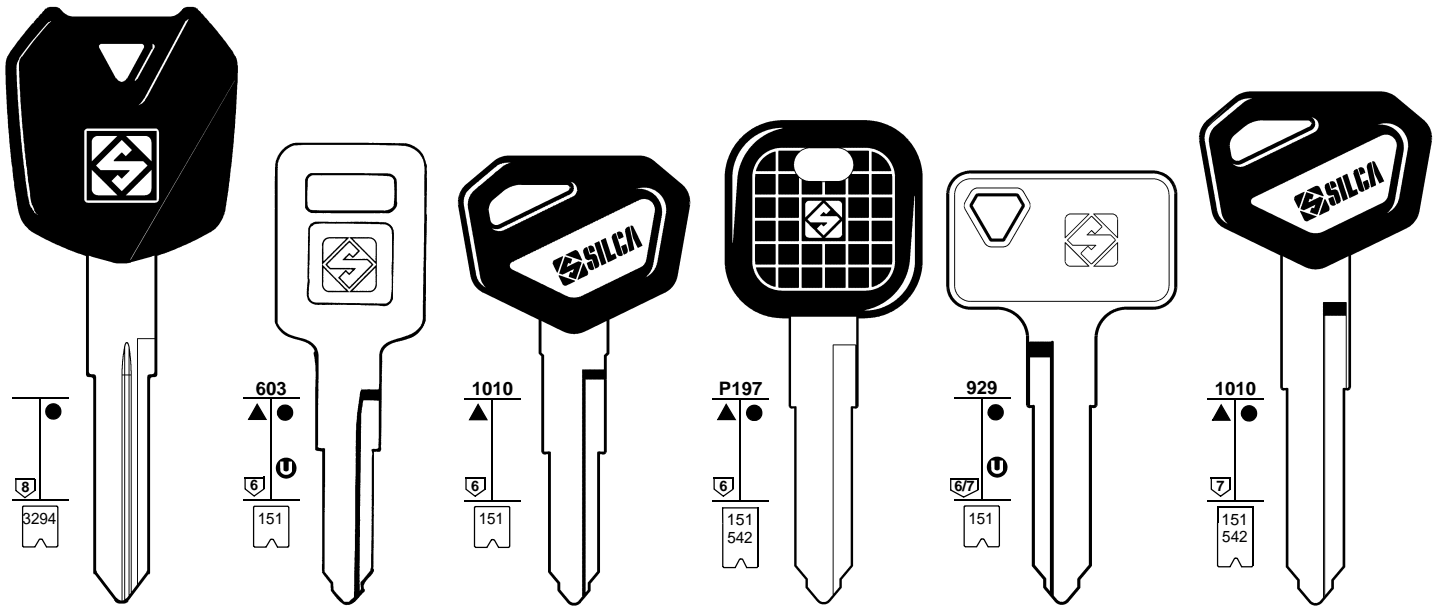

**KW18DP**  
..... 123

**KW12**  
Z ..... 5001-6000  
Z ..... 5001-6000 (NEW)

**KW12BP**  
Z ..... 5001-6000  
Z ..... 5001-6000 (NEW)

**KW14AP**  
B ..... 1234  
H ..... 1234  
..... 8001-9000  
B ..... 8001-9000

**KW14R**  
B ..... 1234  
H ..... 1234  
..... 8001-9000  
B ..... 8001-9000

**KW15BP**  
B ..... 8001-9000

FOR:  
PER:

# KAWASAKI

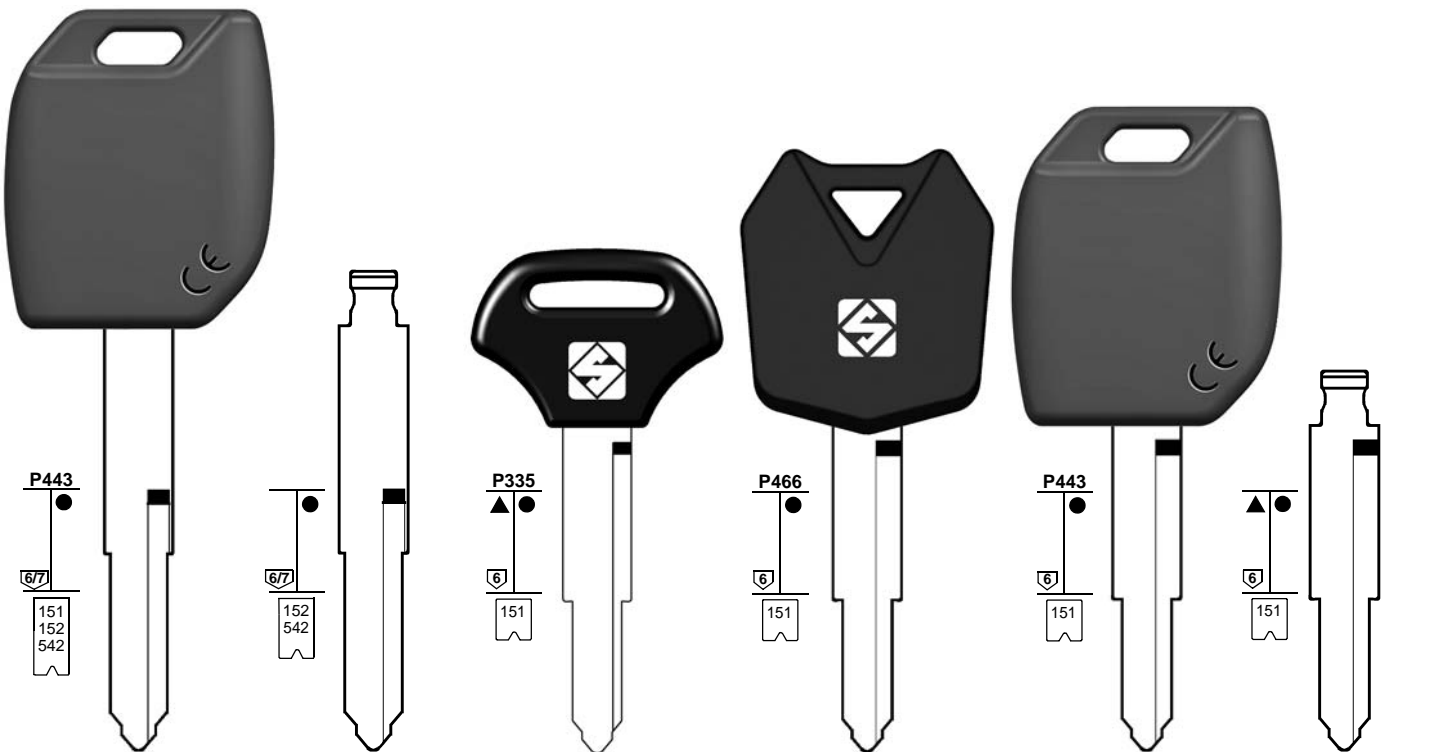

**KW14MH**  
Z ..... 5001-6000  
..... 8001-9000  
B ..... 8001-9000  
B ..... 1234  
H ..... 1234













**KW14FH**  
B ..... 8001-9000

**KW16CP**  
Z .....  
5001-6000

**KW16TE**  
Z .....  
5001-6000

**KW16MH**  
Z ..... 5001-6000  
Z ..... 5001-6000 (NEW)

**KW16FH**  
Z .....  
5001-6000

1	2	2a	3	3a	3b	e1+e2		6	42+71	72	43+44a	12	15
						GTI COMPATIBLE		IGNITION 					
MOTORCYCLE MAKE MODEL	FROM	TO	SILCA REF.	SILCA REF.	SILCA REF.	COPY	GEN.	TRANSP. TYPE	FAST COPY PLUS RW4 PLUS FAST COPY/RW4	FAST COPY PLUS RW4 PLUS	FAST COPY RW4	STP	
													
For more info on the uses of motorcycle keys, refer to the Silca Electronic Keys Catalogue: 													
<b>KAWASAKI</b>													
NINJA 250R	2008		KW18DP										
NINJA 500R	1993	1994	KW15BP										
NINJA 600R	1990	1996	KW12BP										
NINJA 600R	1990	1996	KW12										
NINJA 650	2012							TEX / CR	72				
NINJA 650	2012		KW14MH		KW14FH	Y	Y	TEX / CR	72	Y	P-BOX		
VN1500	1987	2001	KW14R										
VN1500	2002	2003	KW14AP		KW14FH								
VN1600	2003	2008	KW14AP		KW14FH								
VN1700	2009		KW14AP		KW14FH								
VN2000	2004	2010	KW14AP		KW14FH								
VN250	2000	2000	KW14R										
VN400	1999	2000	KW14R										
VN800	1995	2005	KW14R										
ZG1000 CONCOURS	1992	2006	KW12										
ZG1000 CONCOURS	1992	2006	KW12BP										
ZL600 ELIMINATOR	1995	1997	KW12BP										
ZRX1100	1992	2000	KW12										
ZRX1100	1999	2000	KW16CP		KW16FH								
ZRX1100	1999	2000	KW12BP										
ZRX1200	2001	2006	KW16CP		KW16FH								
ZR-7	1999	2005	KW16CP		KW16FH								
ZZR1200	2000	2005	KW16CP		KW16FH								
ZZR1200	2002	2006	KW16MH	KW16TE	KW16FH	Y	Y	TEX / CR	72	Y	P-BOX		
ZZR1400	2007	2011						TEX / CR	72				
ZZR1400	2007	2011	KW16MH	KW16TE	KW16FH	Y	Y	TEX / CR	72	Y	P-BOX		
ZZR1400	2012							TEX / CR	72				
ZZR1400	2012		KW14MH		KW14FH	Y	Y	TEX / CR	72	Y	P-BOX		
ZZR600	1994	2004	KW15BP										
Z1000	2003	2005	KW16CP		KW16FH								
Z1000	2004	2009						TEX / CR	72				
Z1000	2004	2009	KW16MH	KW16TE	KW16FH	Y	Y	TEX / CR	72	Y	P-BOX		
Z1000	2010							TEX / CR	72				
Z1000	2010		KW14MH		KW14FH	Y	Y	TEX / CR	72	Y	P-BOX		
Z500	1991	1998	KW12BP										
Z500	1991	1998	KW12										
Z750	1991	1997	KW12BP										
Z750	1991	1997	KW12										
Z750	1998	2005	KW16CP		KW16FH								
Z750S	2006							TEX / CR	72				
Z750S	2006		KW16MH	KW16TE	KW16FH	Y	Y	TEX / CR	72	Y	P-BOX		
SOME MODELS	1994		KW15BP										
SOME MODELS			KW16CP		KW16FH								

FOR:  
PER:

**KTM**

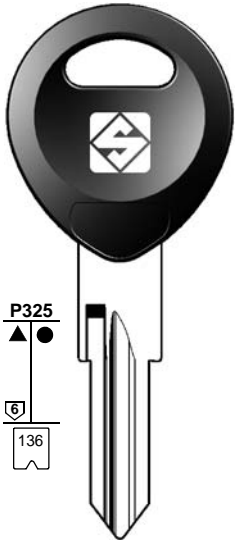

**ZD24RDP**  
 .... 8001-9554  
 .... 1001-2252  
 N... 1-700  
 ... 1-700  
 ..... 1234

**KYMCO**

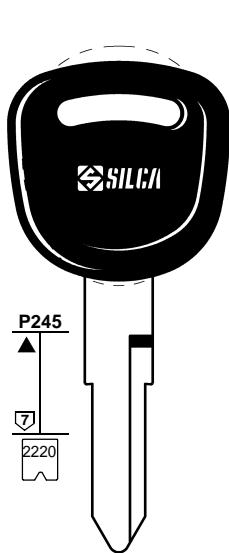

**KYM1P**  
 ..... 1-2-3-4

**KYM1RP**  
 ..... 1-2-3-4

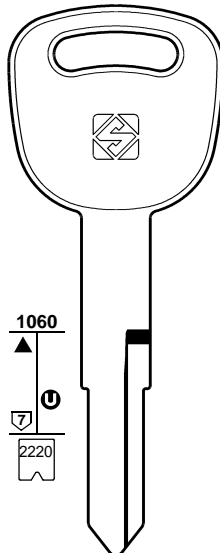

**KYM2**  
 ..... 1-2-3-4

**KYM2R**  
 ..... 1-2-3-4

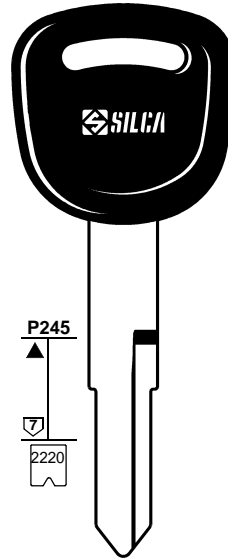

**KYM2P**  
 ..... 1-2-3-4

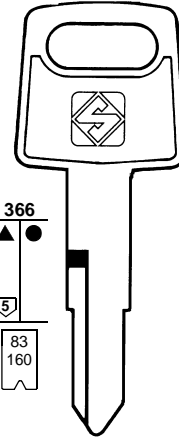

**HON31**  
 ... 121-140  
 ... 521-540  
 ... 621-640  
 ... 721-740  
 ... 821-840  
 ... 221-240  
 ... 421-440  
 ... 321-340  
 C... 00-99  
 D... 00-99

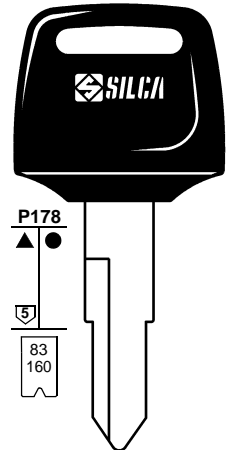

**HON31CP**  
 ... 121-140  
 ... 521-540  
 ... 621-640  
 ... 721-740  
 ... 821-840  
 ... 221-240  
 ... 421-440  
 ... 321-340  
 C... 00-99  
 D... 00-99

FOR:  
PER:

**LAVERDA**

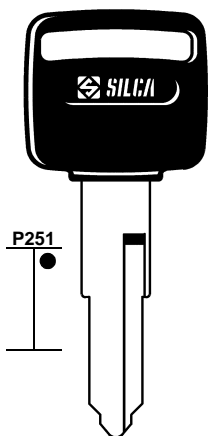

**ZD21P**

**MALAGUTI**

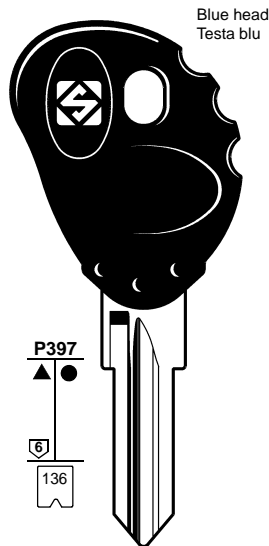

**ZD23RCP**  
 .... 8001-9554

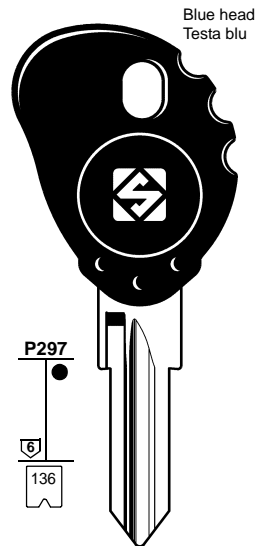



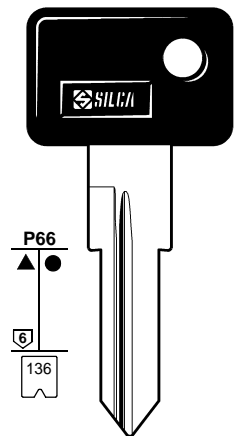













**ZD23RT5**  
 .... 8001-9554



**ZD16RP**  
 .... 8001-9554  
 .N... 1-700  
 ... 1-700



1	2	2a	3	3a	3b	e1+e2	6	42+71	72	43+44a	12	15	
						GTI COMPATIBLE	IGNITION 						
MOTORCYCLE MAKE MODEL	FROM	TO	SILCA REF.	SILCA REF.	SILCA REF.	COPY	GEN.	TRANSP. TYPE	FAST COPY PLUS RW4 PLUS FAST COPY/RW4	FAST COPY PLUS RW4 PLUS	FAST COPY RW4	STP	
													
For more info on the uses of motorcycle keys, refer to the Silca Electronic Keys Catalogue: 													
<b>KTM</b>													
ER-5	2003		ZD24RDP										
<b>KYMCO</b>													
AGILITY	2005		KYM1P										
AGILITY	2005		KYM1RP										
CX50	1997		HON31										
CX50	1997		HON31CP										
DOWNTOWN	2009												
GRANDINK	2001		KYM2P										
HEROISM	1997		KYM1RP										
HEROISM	1997		KYM1P										
KB50	1997		HON31CP										
KB50	1997		HON31										
K1250	1997		HON31										
K1250	1997		HON31CP										
MYROAD	2010												
SNIPER 50DD	1997		HON31										
SNIPER 50DD	1997		HON31CP										
SOME MODELS	1997		KYM2R										
SOME MODELS	1997		KYM2										
SOME MODELS	1997		KYM1RP										
SOME MODELS	1997		KYM1P										
<b>LAVERDA</b>													
PHOENIX	2003		ZD21P										
<b>MALAGUTI</b>													
CENTRO SL	1994		ZD16RP										
CROSSER 50	1994		ZD16RP										
F10 JET	1994		ZD16RP										
F15 FIREFOX	1996		ZD23RCP										
F15 FIREFOX	1996		ZD23RT5				TEMIC	12	Y	Y		S7	
MADISON	2003		ZD23RCP										
PHANTOM F12	1994		ZD16RP										
<b>MBK</b>													
BOOSTER	1995	1997	ZD16RP see picture on page 414										
BOOSTER	1997	2004	ZD23RT5 see picture on page 414				TEMIC	12	Y	Y			
BOOSTER	1998	1999	ZD24RDP see picture on page 414										
BOOSTER	1999	2004	ZD24RT5 see picture on page 414		ZD24RFH see picture on page 414		TEMIC	12	Y	Y			
EVOLIS	1995	1998	ZD16RP see picture on page 414										
FORTE	1995		ZD16RP see picture on page 414										
KILIBRE	2003	2004	ZD24RDP see picture on page 414										
NEW SORRISO	1995		ZD16RP see picture on page 414										
OVETTO	1998	2004	ZD24RDP see picture on page 414										
OVETTO	1998	2004	ZD23RT5 see picture on page 414				TEMIC	12	Y	Y			

FOR:  
PER:

# MOTO GUZZI

# MZ

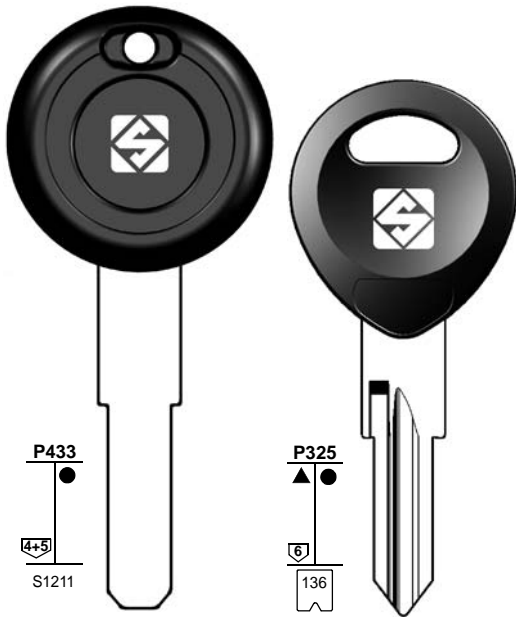

**ZD30T5**  
Z . . . . . 2001-9416



**ZD24RDP**

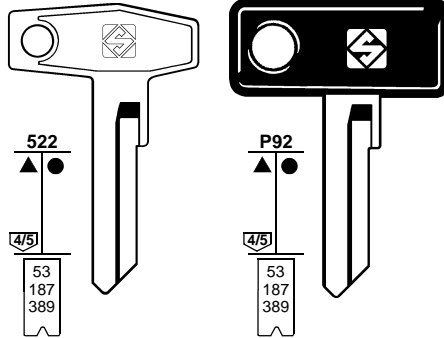

**ZD9**  
E . . . . . 1-500  
E . . . . . 501-710  
. . . . . 1-1625  
. . . . . 9001-9500  
. . . . . 5001-6278

**ZD9P**  
E . . . . . 1-500  
E . . . . . 501-710  
. . . . . 1-1625  
. . . . . 9001-9500  
. . . . . 5001-6278

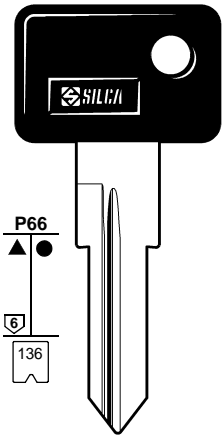

**ZD16RP**  
. . . . . 8001-9554  
. N . . . . . 1-700  
. . . . . 1-700

FOR:  
PER:

# PEUGEOT

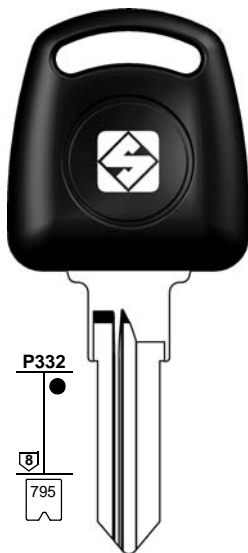



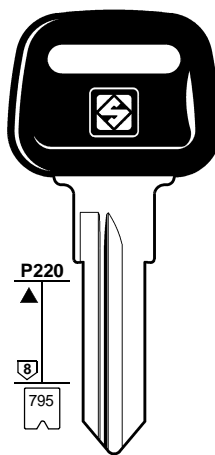



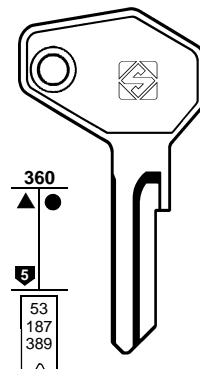









**NE74T5**  
CP . . . . . 1-2-3-4



**NE74P**  
CP . . . . . 1-2-3-4



**ZD7**  
. . . . . 9001-9500  
E . . . . . 501-710  
E . . . . . 1-500  
. . . . . 1-1625

1	2	2a	3	3a	3b	e1+e2	6	42+71	72	43+44a	12	15	
						GTI COMPATIBLE	IGNITION 						
MOTORCYCLE MAKE MODEL	FROM	TO	SILCA REF.	SILCA REF.	SILCA REF.	COPY	GEN.	TRANSP. TYPE	FAST COPY PLUS RW4 PLUS FAST COPY/RW4	FAST COPY PLUS RW4 PLUS	FAST COPY RW4	STP	
													
For more info on the uses of motorcycle keys, refer to the Silca Electronic Keys Catalogue: 													
<b>MOTO GUZZI</b>													
350 NEVADA	1994	2002	ZD9P										
350 NEVADA	1994	2002	ZD9										
750 NEVADA	1994	2002	ZD9P										
750 NEVADA	1994	2002	ZD9										
BELLAGIO	2006		ZD30T5					TEMIC	12	Y	Y		
BREVA	2003	2011	ZD24RDP										
CALIFORNIA EV	2003	2006	ZD24RDP										
GRISO	2006		ZD30T5					TEMIC	12	Y	Y		
NORGE	2006		ZD30T5					TEMIC	12	Y	Y		
STELVIO	2007		ZD30T5					TEMIC	12	Y	Y		
V11	2003	2006	ZD24RDP										
<b>MOTO MORINI</b>													
CORSARO 1200	2006												
<b>MV AUGUSTA</b>													
CRC BRUTALE S	2004												
<b>MZ</b>													
TOUR	1994		ZD16RP										
SOME MODEL	1994		ZD16RP										
<b>PEUGEOT</b>													
Alisé	1998		NE74T5					TEMIC	11	Y	Y	T-F	S8
BUXY	1994	1997	ZD7										
ELISEO	1998		NE74T5					TEMIC	11	Y	Y	T-F	S8
ELYSTAR	2002		NE74T5					TEMIC	11	Y	Y	T-F	S8
FOX	1994	1998	ZD7										
GÉOPOLIS	2006		NE74T5					TEMIC	11	Y	Y	T-F	S8
JET FORCE	2003		NE74T5					TEMIC	11	Y	Y	T-F	S8
LOOXOR	2001		NE74P										
LOOXOR	2001		NE74T5					TEMIC	11	Y	Y	T-F	S8
LUDIX	2004		NE74P										
SPEEDAKE	1995	1997	ZD7										
SPEEDFIGHT	1997		NE74T5					TEMIC	11	Y	Y	T-F	S8
SPEEDFIGHT	1997		NE74P										
SQUAB	1995	1997	ZD7										
SQUAB	1997		NE74P										
SV	1996		NE74T5					TEMIC	11	Y	Y	T-F	S8
SV GEO	1991	1995	NE74P										
TREKKER	1998		NE74P										
VIVACITY	1999		NE74P										
VIVACITY	1999		NE74T5					TEMIC	11	Y	Y	T-F	S8
X-FIGHT	2001		NE74T5					TEMIC	11	Y	Y	T-F	S8
X-RACE	2003		NE74P										
ZENITH	1994	1996	ZD7										
SOME MODELS	1997		NE74P										

FOR:  
PER:

# PIAGGIO

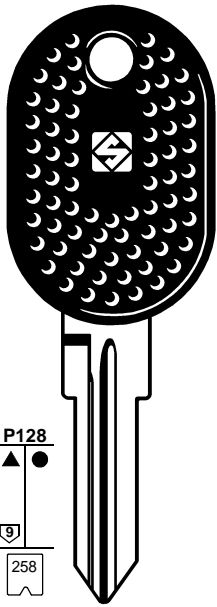

**GT15RP**  
W . . . . 0001-9640

TRW SIPEA

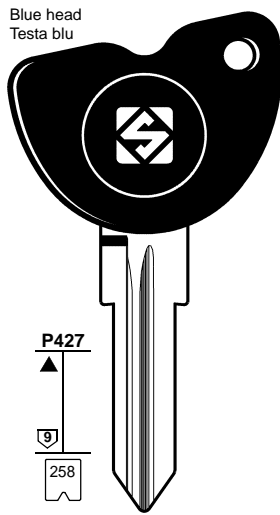

**GT15RDP**  
W . . . . 0001-9640  
..... 123

TRW SIPEA

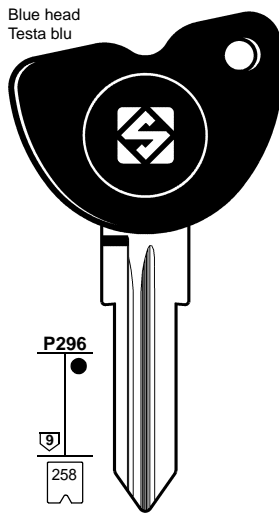

**GT15RDT5**  
W . . . .  
0001-9640

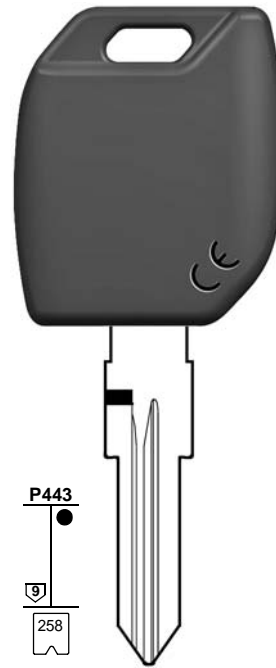

**GT15RMH**  
W . . . . 0001-9640

TRW SIPEA

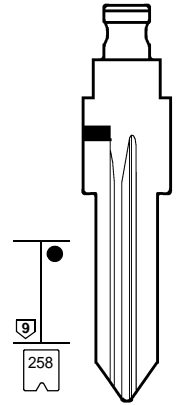

**GT15RFH**  
W . . . . 0001-9640

FOR:  
PER:

# PIAGGIO

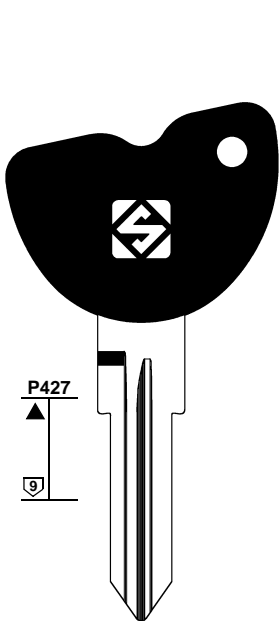

**GT20RDP**  
W . . . . 1-9640

GIOBERT - TRW SIPEA

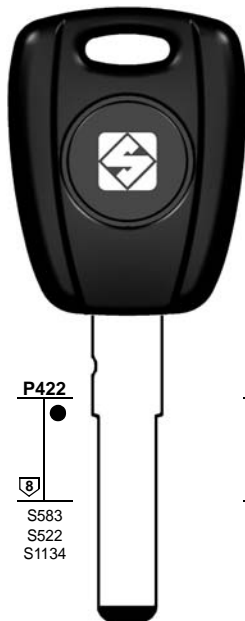

**SIP22T5**  
DE . . . .  
1-11210

GIOBERT - TRW SIPEA

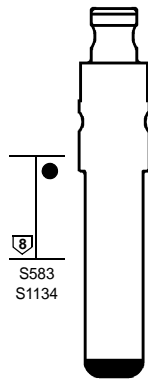

**SIP22FH**  
DE . . . . 1-11210

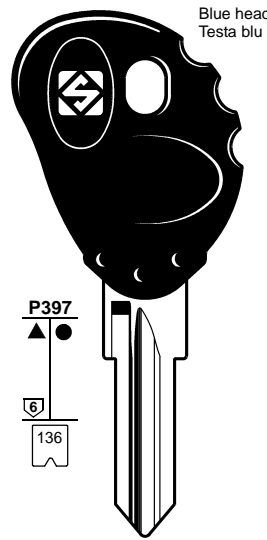

**ZD23RCP**  
..... 8001-9554

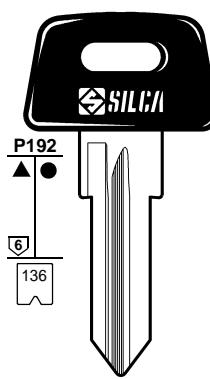

**ZD17RAP**  
..... 8001-9554

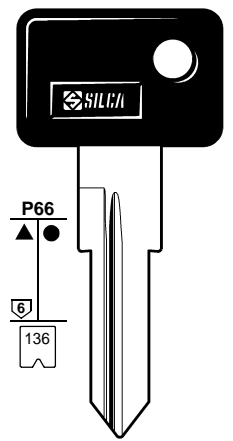

**ZD16RP**  
..... 8001-9554  
.N . . . . 1-700  
... 1-700



FOR:  
PER:

**RIZZATO**

**SUZUKI**

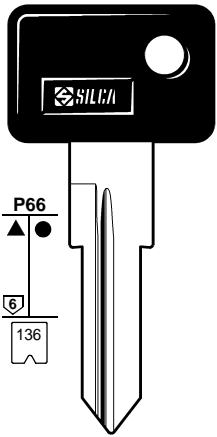

**ZD16RP**

... 8001-9554  
.N ... 1-700  
... 1-700

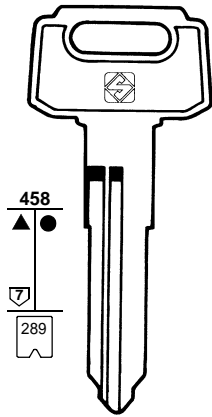

**SZ10R**

... 6001-7000

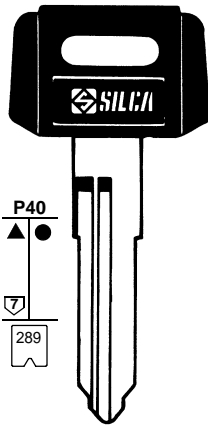

**SZ10RP**

... 6001-7000

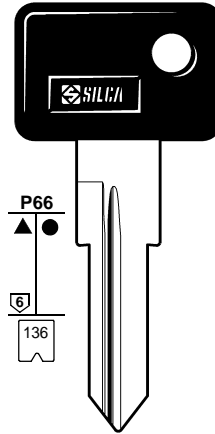

**ZD16RP**

... 8001-9554  
.N ... 1-700  
... 1-700

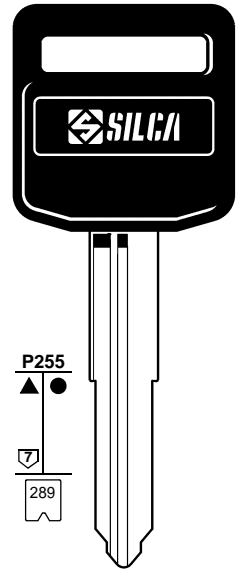

**SZ14RAP**

... 6001-7000  
A ... 6001-7000

FOR:  
PER:

**SUZUKI**

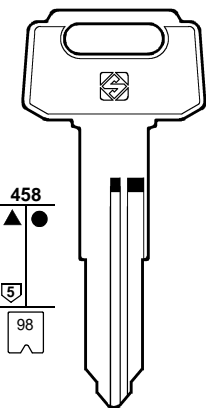

**YH29**

D ... 32010-79897  
D ... 1234



**YH30**

E ... 32010-79897  
E ... 1234  
F ... 32010-79897  
F ... 1234

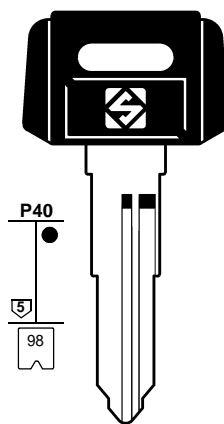

**YH29P**

D ... 32010-79897  
D ... 1234

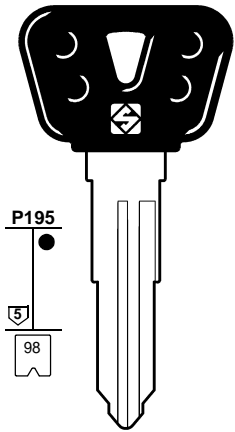

**YH30BP**

E ... 32010-79897  
E ... 1234  
F ... 32010-79897  
F ... 1234

**YH29R**

C ... 32010-79897  
C ... 1234

**YH30R**

E ... 32010-79897  
E ... 1234

**YH29RP**

C ... 32010-79897  
C ... 1234  
E ... 32010-79897  
E ... 1234

**YH30RBP**

E ... 32010-79897  
E ... 1234



FOR:  
PER:

# SUZUKI

Technical drawings of six Suzuki keys with their respective specifications:

- SZ10R**: P458, 289
- SZ10RP**: P40, 289
- SZ14RAP**: P255, 289
- SZ17RMH**: P443, 289 (MH KEY)
- SZ17RTE**: P464, 289 (TE KEY)
- SZ17RFH**: P57, 289 (FH FLIP)

FOR:  
PER:

# SUZUKI

















Technical drawings of four Suzuki keys with their respective specifications:

- ZD16RP**: P66, 136
- ZD24RDP**: P325, 136
- YH30**: P458, 98
- YH30BP**: P195, 98

Additional specifications for YH30 and YH30BP:

- YH30**: E ..... 32010-79897, E ..... 1234, F ..... 32010-79897, F ..... 1234
- YH30BP**: E ..... 32010-79897, E ..... 1234, F ..... 32010-79897, F ..... 1234



1	2	2a	3	3a	3b	e1+e2		6	42+71	72	43+44a	12	15
						GTI COMPATIBLE		IGNITION 					
MOTORCYCLE MAKE MODEL	FROM	TO	SILCA REF.	SILCA REF.	SILCA REF.	COPY	GEN.	TRANSP. TYPE	FAST COPY PLUS RW4 PLUS FAST COPY/RW4	FAST COPY PLUS RW4 PLUS	FAST COPY RW4	STP	
													
For more info on the uses of motorcycle keys, refer to the Silca Electronic Keys Catalogue: 													
<b>SUZUKI</b>													
GSF BANDIT	2007		SZ17RMH	SZ17RTE	SZ17RFH	Y	Y	TEX / CR	71	Y	P-BOX		
GSF400	1991	1993	SZ10R										
GSF400	1991	1993	SZ10RP										
GSF600	1996	2004	SZ14RAP										
GSR600	2007							TEX / CR	71				
GSR600	2007		SZ17RMH	SZ17RTE	SZ17RFH	Y	Y	TEX / CR	71	Y	P-BOX		
GSX KATANA	1997		ZD16RP										
GSX-R1000	2001	2006	SZ14RAP										
GSX-R1000	2006							TEX / CR	71				
GSX-R1000	2006		SZ17RMH	SZ17RTE	SZ17RFH	Y	Y	TEX / CR	71	Y	P-BOX		
GSX-R1100	1995	1998	SZ14RAP										
GSX-R600	1997	2006	SZ14RAP										
GSX-R600	2006							TEX / CR	71				
GSX-R600	2006		SZ17RMH	SZ17RTE	SZ17RFH	Y	Y	TEX / CR	71	Y	P-BOX		
GSX-R750	1997	2006	SZ14RAP										
GSX-R750	2006							TEX / CR	71				
GSX-R750	2006		SZ17RMH	SZ17RTE	SZ17RFH	Y	Y	TEX / CR	71	Y	P-BOX		
GSX1200	1999	2000	SZ14RAP										
GSX1300 HAYABUSA	1999	2006	SZ14RAP										
GSX1300 HAYABUSA	2007							TEX / CR	71				
GSX1300 HAYABUSA	2007		SZ17RMH	SZ17RTE	SZ17RFH	Y	Y	TEX / CR	71	Y	P-BOX		
GSX1400	2002	2005	SZ14RAP										
GSX600	1998	2006	SZ14RAP										
GSX650	2008		SZ14RAP										
GSX750	1988	2006	SZ14RAP										
GS500	1995	2003	SZ10RP										
GS500	2004		SZ14RAP										
GZ125	1998		SZ14RAP										
KATANA R	2004		ZD24RDP										
LS650	1995	2009	YH30BP										
LS650	1995	2009	YH30R										
LS650	1995	2009	YH30										
LS650	1995	2009	YH30RBP										
MARAUDER GZ250	2004		SZ14RAP										
MARAUDER VZ1600	2004		SZ14RAP										
RF600R	1993	1997	SZ10RP										
RF600R	1993	1997	SZ10R										
RF900R	1994	1998	SZ10RP										
RF900R	1994	1998	SZ10R										
RG125	1995	1999	SZ10R										
RG125	1995	1999	SZ10RP										
RV125	2003		SZ14RAP										
SV1000	2003	2007	SZ14RAP										
SV650	2004		SZ14RAP										
SV750	2004		SZ14RAP										
TL1000	1997	2002	SZ14RAP										

FOR:  
PER:

# SUZUKI

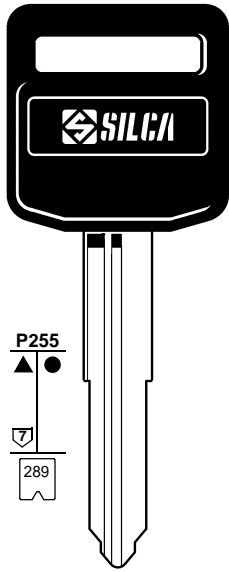

**SZ14RAP**  
... 6001-7000  
A ... 6001-7000

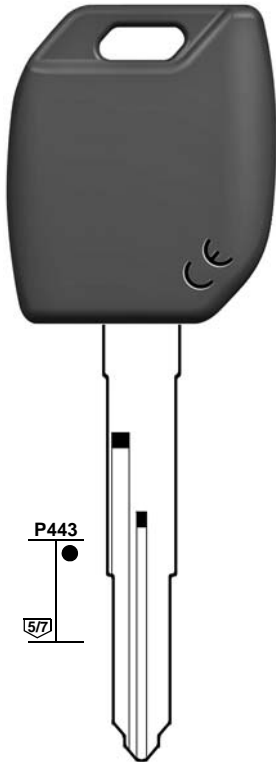

**SZ17RMH**  
A ... 301-500  
S ... 6001-7000

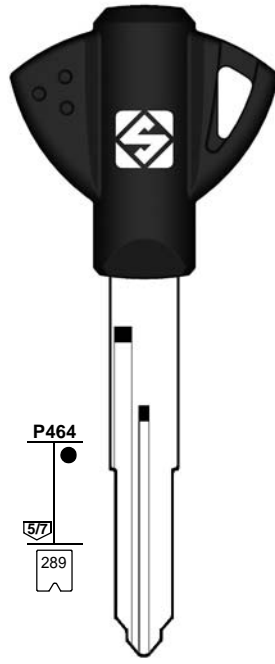

**SZ17RTE**  
A ... 301-500  
S ... 6001-7000

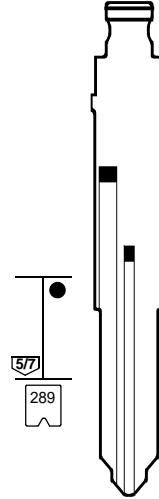

**SZ17RFH**  
A ... 301-500  
S ... 6001-7000

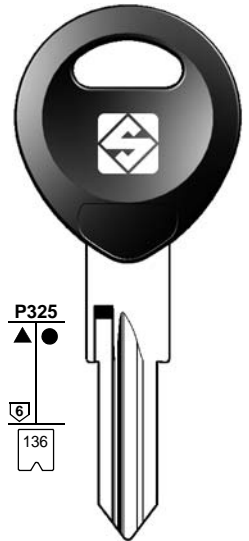

**ZD24RDP**  
... 8001-9554  
... 1001-2252  
N ... 1-700  
... 1-700  
... 1234

FOR:  
PER:

# SUZUKI

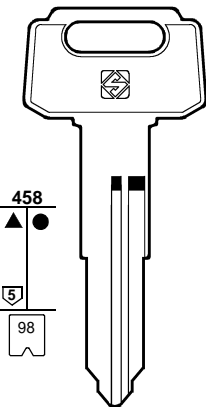

**YH29**  
D ... 32010-79897  
D ... 1234

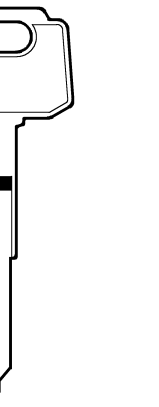

**YH30**  
E ... 32010-79897  
E ... 1234  
F ... 32010-79897  
F ... 1234

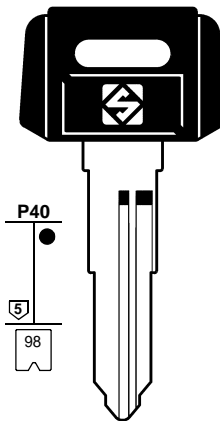

**YH29P**  
D ... 32010-79897  
D ... 1234

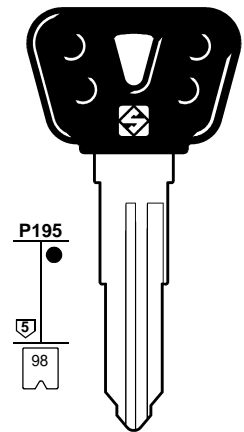

**YH30BP**  
E ... 32010-79897  
E ... 1234  
F ... 32010-79897  
F ... 1234

**YH29R**  
C ... 32010-79897  
C ... 1234

**YH30R**  
E ... 32010-79897  
E ... 1234

**YH29RP**  
C ... 32010-79897  
C ... 1234  
E ... 32010-79897  
E ... 1234

**YH30RBP**  
E ... 32010-79897  
E ... 1234



FOR:  
PER:

# TRIUMPH

Blue head  
Testa blu

**ZD24RDP**  
 P325  
 ▲ ●  
 6  
 136

**ZD24RTE**  
 P457  
 ●  
 6  
 136

**ZD24RMH**  
 P443  
 ●  
 6  
 136

**ZD24RFH**  
 ●  
 6  
 136

**ZD24RDP**  
 ... 8001-9554  
 ... 1001-2252  
 N ... 1-700  
 ... 1-700  
 ..... 1234

**ZD24RTE**  
 ... 8001-9554  
 ... 1-700  
 N ... 1-700

**ZD24RMH**  
 ... 8001-9554  
 ... 1-700  
 N ... 1-700

**ZD24RFH**  
 ... 8001-9554  
 ... 1-700  
 N ... 1-700  
 ... 1234  
 ... 1001-2252

FOR:  
PER:

# YAMAHA

Blue head  
Testa blu

**YH35RAT22**  
 P432  
 ●  
 7  
 289

**ZD16RP**  
 P66  
 ▲ ●  
 6  
 136

**ZD24RDP**  
 P325  
 ▲ ●  
 6  
 136

**ZD24RT5**  
 P297  
 ●  
 6  
 136

**ZD24RFH**  
 ●  
 6  
 136

**YH35RAT22**  
 A ... 7001-8500  
 B ... 7001-8000  
 C ... 7001-8000

**ZD16RP**  
 ... 8001-9554  
 .N ... 1-700  
 ... 1-700

**ZD24RDP**  
 ... 8001-9554  
 ... 1001-2252  
 N ... 1-700  
 ... 1-700  
 ..... 1234

**ZD24RT5**  
 ... 8001-9554  
 ... 1001-2252  
 N ... 1-700  
 ... 1-700

**ZD24RFH**  
 ... 8001-9554  
 ... 1001-2252  
 N ... 1-700  
 ... 1-700  
 ..... 1234



FOR:  
PER:

# YAMAHA

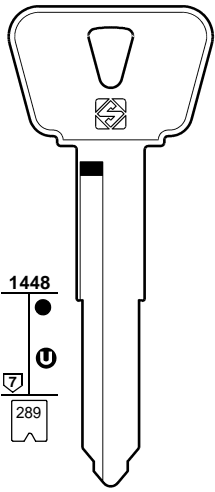

**YH35R**

A . . . . 7001-8500  
B . . . . 7001-8000  
C . . . . 7001-8000

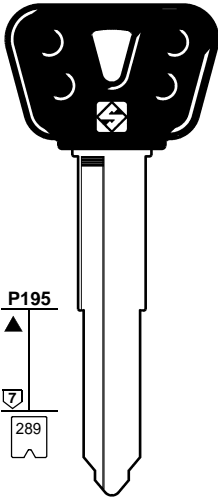

**YH35RBP**

A . . . . 7001-8500  
B . . . . 7001-8000  
C . . . . 7001-8000

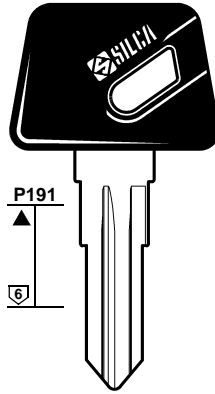

**YH34P**

**YH34RP**

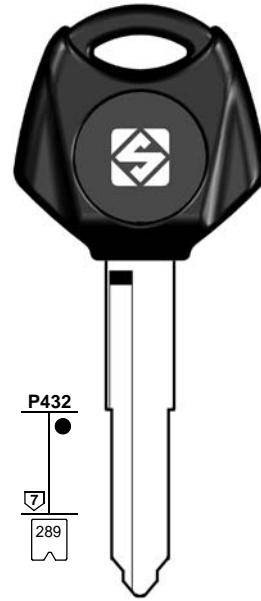

**YH35RAT22**

A . . . . 7001-8500  
B . . . . 7001-8000  
C . . . . 7001-8000

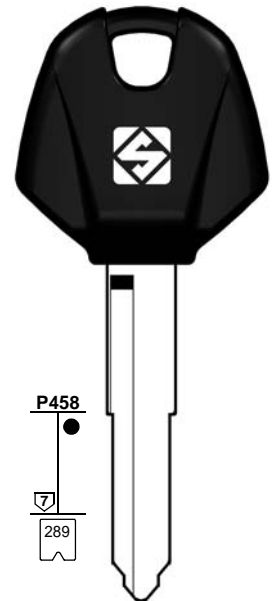

**YH35RATE**

A . . . . 7001-8500  
B . . . . 7001-8000  
C . . . . 7001-8000

FOR:  
PER:

# YAMAHA

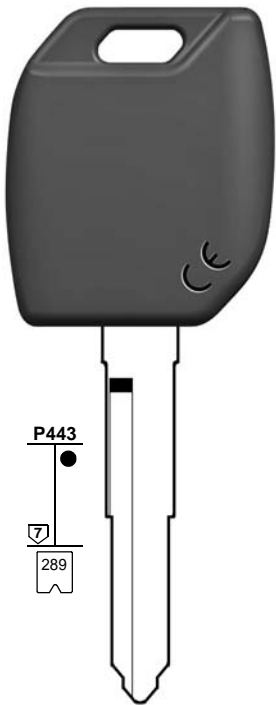

**YH35RMH**

A . . . . 7001-8500  
B . . . . 7001-8000  
C . . . . 7001-8000

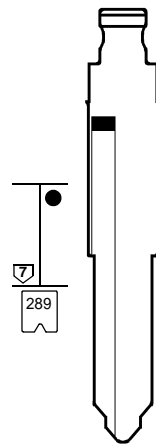

**YH35RFH**

A . . . . 7001-8500  
B . . . . 7001-8000  
C . . . . 7001-8000



**ZD24RDP**

. . . . 8001-9554  
. . . . 1001-2252  
N . . . . 1-700  
. . . . 1-700  
. . . . 1234



FOR:  
PER:

# YAMAHA

Blue head  
Testa blu

Blue head  
Testa blu

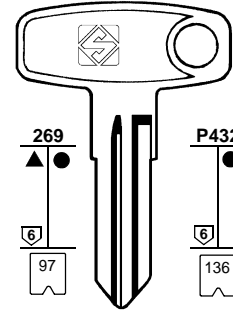
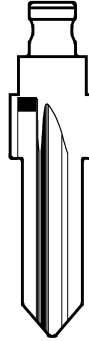
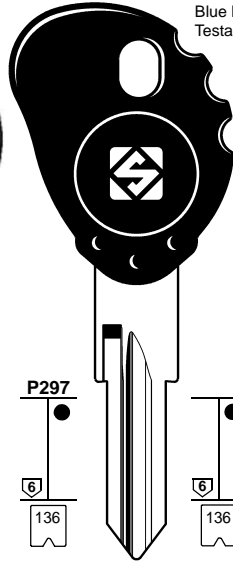
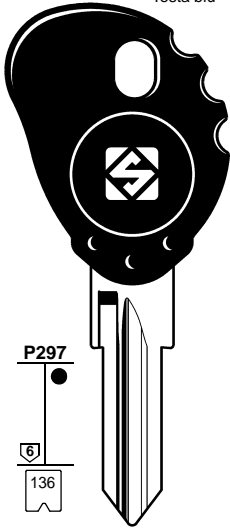
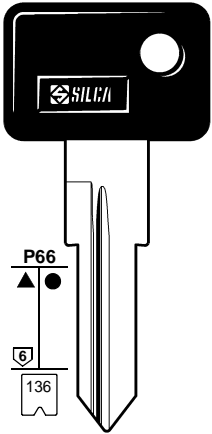

**ZD16RP**  
... 8001-9554  
N ... 1-700  
... 1-700



**ZD23RT5**  
... 8001-9554



**ZD24RDP**  
... 8001-9554  
... 1001-2252  
N ... 1-700  
... 1-700  
... 1234



**ZD24RT5**  
... 8001-9554  
... 1001-2252  
N ... 1-700  
... 1-700



**ZD24RFH**  
... 1-700  
N ... 1-700  
... 1234  
... 1001-2252



**YH14**  
... 4851-4900  
... 4251-4300  
... 3801-3850



**ZD24RAT22**  
... 8001-9554



**ZD24RTE**  
... 8001-9554  
N ... 1-700  
... 1-700

(head code P459)

FOR:  
PER:

# YAMAHA

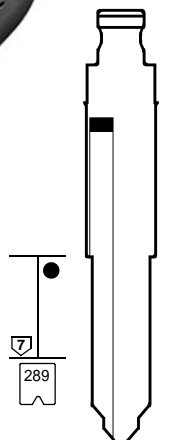
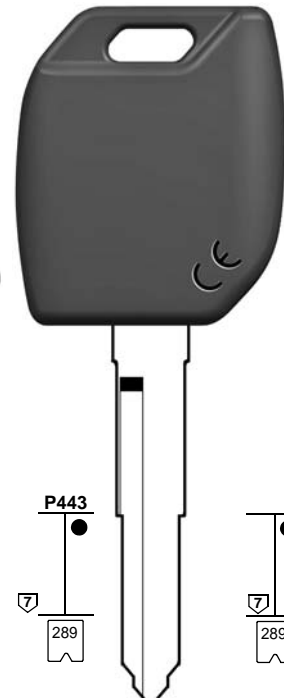
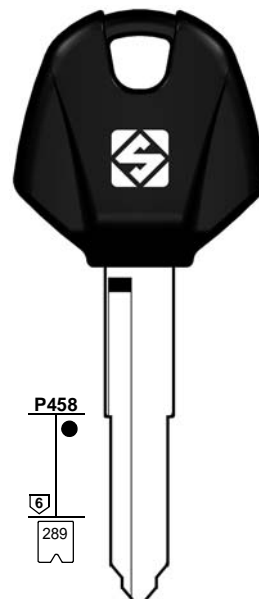
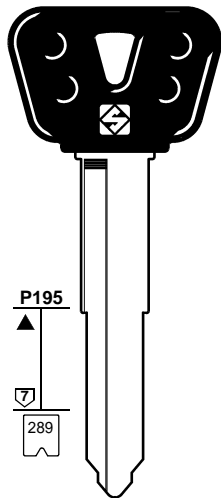
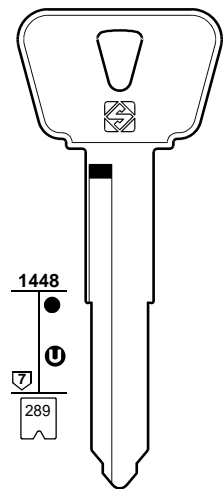

**YH35R**  
A ... 7001-8500  
B ... 7001-8000  
C ... 7001-8000

**YH35RBP**  
A ... 7001-8500  
B ... 7001-8000  
C ... 7001-8000

**YH35RAT22**  
A ... 7001-8500  
B ... 7001-8000  
C ... 7001-8000

**YH35RATE**  
A ... 7001-8500  
B ... 7001-8000  
C ... 7001-8000

**YH35RMH**  
A ... 7001-8500  
B ... 7001-8000  
C ... 7001-8000

**YH35RFH**  
A ... 7001-8500  
B ... 7001-8000  
C ... 7001-8000



1	2	2a	3	3a	3b	e1+e2		6	42+71	72	43+44a	12	15
						GTI COMPATIBLE		IGNITION					
MOTORCYCLE MAKE MODEL	FROM	TO	SILCA REF.	SILCA REF.	SILCA REF.	COPY	GEN.	TRANSP. TYPE	FAST COPY PLUS RW4 PLUS FAST COPY/RW4	FAST COPY PLUS RW4 PLUS	FAST COPY RW4	STP	
For more info on the uses of motorcycle keys, refer to the Silca Electronic Keys Catalogue:													
<b>YAMAHA</b>													
Neos	1998		ZD24RT5		ZD24RFH			MEG	13	Y	Y		
SPY	1995		ZD16RP										
TDM	1996	2001	YH35R										
TDM	1996	2001	YH35RBP										
TDM600	2005		YH35RAT22					TEX / CR	69				S12
TDM600	2005		YH35RMH	YH35RATE	YH35RFH	Y	Y	TEX / CR	69	Y	P-BOX		
TDM850	1995	2001	YH35RBP										
TDM850	1995	2001	YH35R										
T-MAX 500	2005	2012	YH35RAT22					TEX / CR	69				S12
T-MAX 500	2005	2012	YH35RMH	YH35RATE	YH35RFH	Y	Y	TEX / CR	69	Y	P-BOX		
TRX850	1995	1999	YH35R										
TRX850	1995	1999	YH35RBP										
TT350	1995		YH14										
Versity 300	2003	2006	ZD24RDP										
XJR 1300	2004		YH35RAT22					TEX / CR	69				S12
XJR 1300	2004		YH35RMH	YH35RATE	YH35RFH	Y	Y	TEX / CR	69	Y	P-BOX		
X-MAX 125	2006		ZD24RAT22					TEX / CR	69				S12
X-MAX 125	2006		ZD24RMH <small>see picture on page 410</small>	ZD24RTE	ZD24RFH	Y	Y	TEX / CR	69	Y	P-BOX		
X-MAX 250	2005		ZD23RT5					TEMIC	12	Y	Y		
XTR	2004		YH35RAT22					TEX / CR	69				S12
XTR	2004		YH35RMH	YH35RATE	YH35RFH	Y	Y	TEX / CR	69	Y	P-BOX		
XTX	2004		YH35RAT22					TEX / CR	69				S12
XTX	2004		YH35RMH	YH35RATE	YH35RFH	Y	Y	TEX / CR	69	Y	P-BOX		
XTZ660	1996	1998	YH35R										
XTZ660	1996	1998	YH35RBP										
XT1200Z Super Ténéré	2010		YH35RAT22					TEX / CR	69				S12
XT1200Z Super Ténéré	2010		YH35RMH	YH35RATE	YH35RFH	Y	Y	TEX / CR	69	Y	P-BOX		
XT600E	1994	2003	YH35RBP										
XT600E	1994	2003	YH35R										
XT660Z Ténéré	2008		YH35RAT22					TEX / CR	69				S12
XT660Z Ténéré	2008		YH35RMH	YH35RATE	YH35RFH	Y	Y	TEX / CR	69	Y	P-BOX		
XVS1100 DragStar	1998	2003	YH35RBP										
XVS1100 DragStar	1998	2003	YH35R										
XVS1100A DragStar	2004		YH35RAT22					TEX / CR	69				S12
XVS1100A DragStar	2004		YH35RMH	YH35RATE	YH35RFH	Y	Y	TEX / CR	69	Y	P-BOX		
XVS650 DragStar	1996	2003	YH35R										
XVS650 DragStar	1996	2003	YH35RBP										
XVS650A DragStar	2004	2006	YH35RAT22					TEX / CR	69				S12
XVS650A DragStar	2004	2006	YH35RMH	YH35RATE	YH35RFH	Y	Y	TEX / CR	69	Y	P-BOX		
XVZ1300	1996	2002	YH35RBP										
XVZ1300	1996	2002	YH35R										
YP250 Majestic	1996		YH35RBP										
YP250 Majestic	1996		YH35R										
YZF-R1	2005		YH35RAT22					TEX / CR	69				S12
YZF-R1	2005		YH35RMH	YH35RATE	YH35RFH	Y	Y	TEX / CR	69	Y	P-BOX		
YZF-R6	2003		YH35RAT22					TEX / CR	69				S12
YZF-R6	2003		YH35RMH	YH35RATE	YH35RFH	Y	Y	TEX / CR	69	Y	P-BOX		
YZF1000	1996	2003	YH35RBP										
YZF1000	1996	2003	YH35R										
YZF600	1994	2005	YH35R										
YZF600	1994	2005	YH35RBP										
SOME MODELS	1995		YH35R										
SOME MODELS	1995		YH35RBP										
SOME MODELS	1995		YH35										
SOME MODELS	2010		YH37RBP										



Truck keys guide  
Guida chiavi camion  
Marktführer für LKW Schlüssel  
Guide clés pour camions  
Guía llaves para camiones  
Guia chaves para camiões

FOR:  
PER:

### DAF

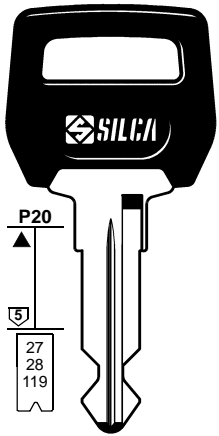

P20  
5  
27  
28  
119



**NE92P**

..... A/Z BCDE  
..... A/Z BDEGHJ  
1/9 ..... A/Z BDEGHJ  
1/9 ..... BDEGHJ  
1/9 ..... A/Z BDEGHJ  
1/9 ..... A/Z EMNPR  
1/9 ..... A/Z EMNPR

VALEO

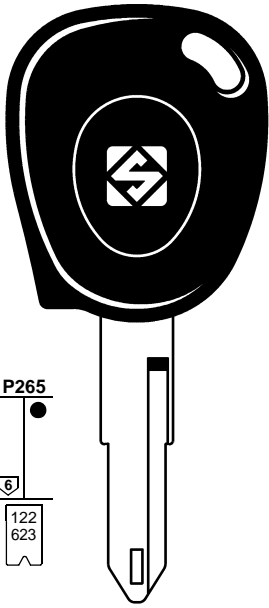

P265  
6  
122  
623



**NE73T6**

..... 0/90/9 MNPRS

VALEO

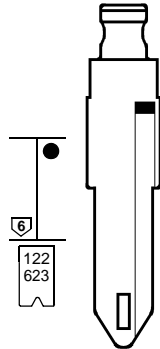

6  
122  
623



**NE73FH**

..... MNPRS

### FORD USA

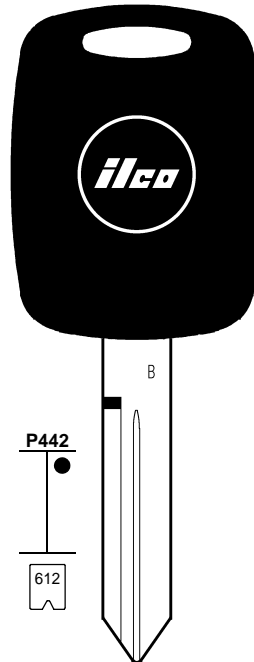

P442  
612



**H72-EK3**

..... X  
1-1706

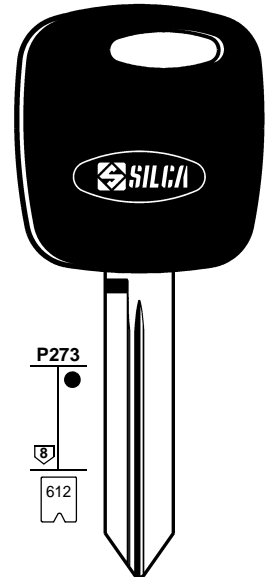

P273  
8  
612



**FO38RT3**

..... X  
0001-1706

FOR:  
PER:

### FORD USA

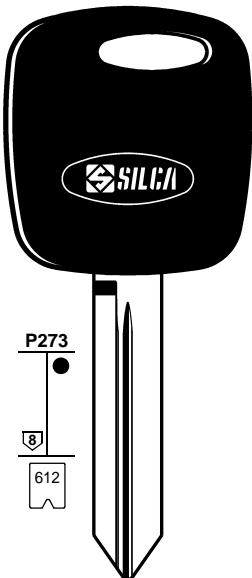

P273  
8  
612



**FO38RTE**

..... X  
0001-1706



P443  
8  
612



**FO38RMH**

..... X  
0001-1706

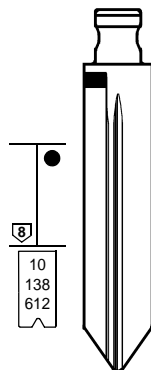

8  
10  
138  
612



**FO38RFH**

..... A ... 101-381.501-579  
..... B ... 101-410.501-602  
..... C ... 101-404.501-624  
..... D ... 101-340.501-602  
..... E ... 101-304.501-579  
..... X 1-1706

### ISUZU

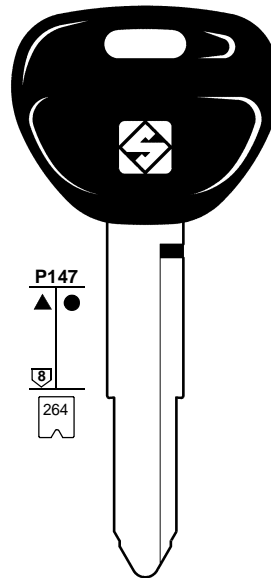

P147  
8  
264



**MIT15AP**

E ..... 5001-7000  
E ..... 7001-7700

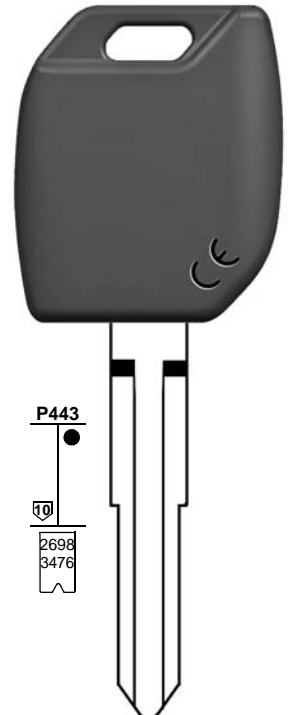

P443  
10  
2698  
3476





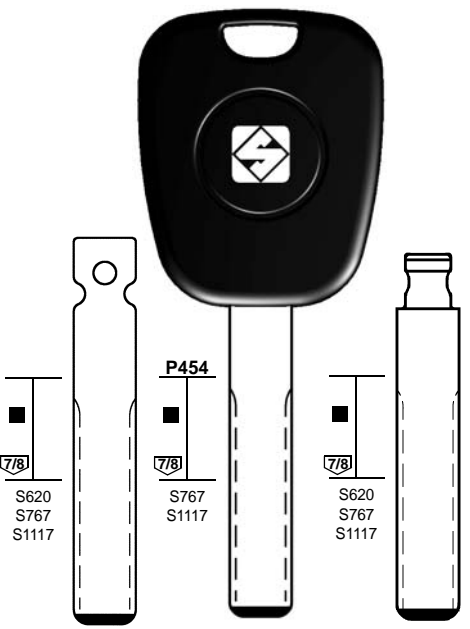
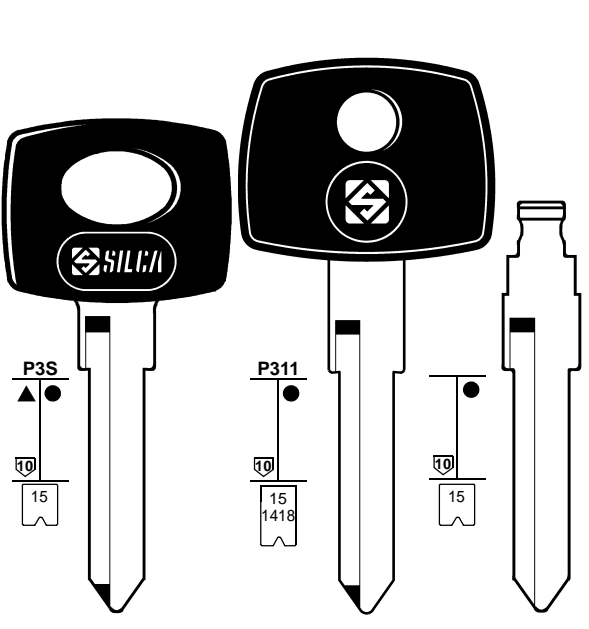
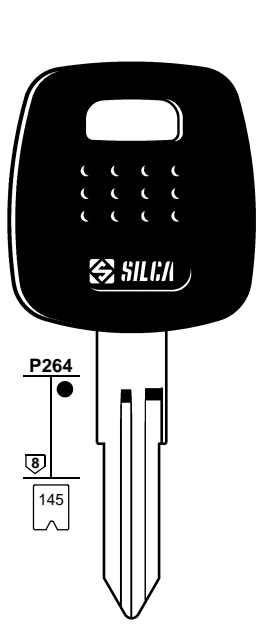

**ISU5MH**

..... 80000-80999

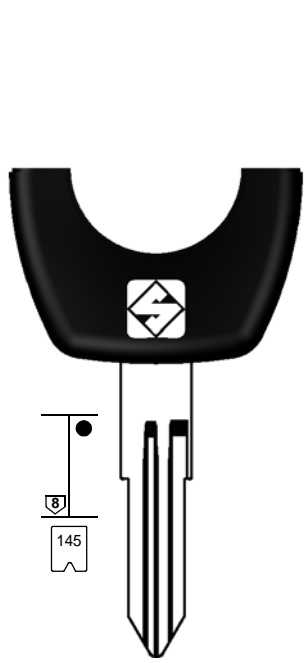
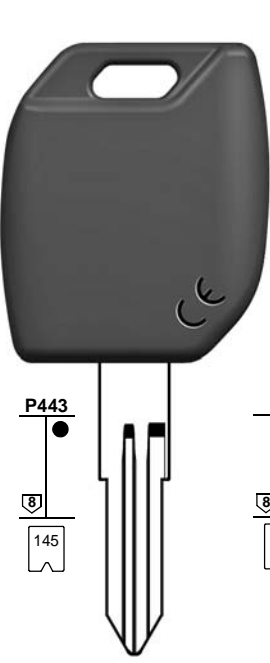

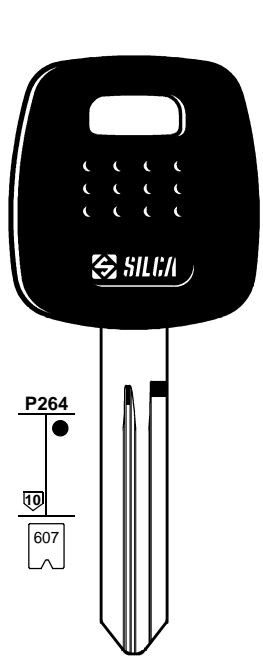
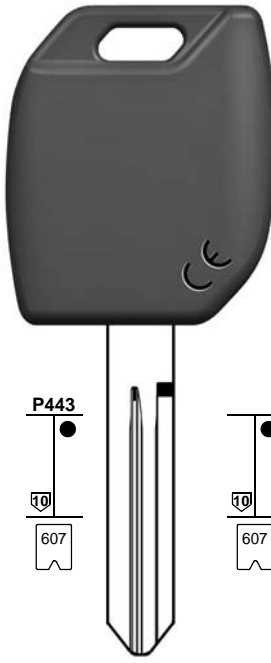
FOR: PER:	MAN	MERCEDES	NISSAN
	 <p>P454</p> <p>S620 S767 S1117</p> <p>S620 S767 S1117</p> <p>S620 S767 S1117</p> <p><b>HU83T</b> ..... 1-2000</p> <p><b>HU83T5</b> ..... 1-2000</p> <p><b>HU83FH</b> ..... 1-2000</p> <p>VALEO</p>	 <p>P3S</p> <p>P311</p> <p>15</p> <p>15 1418</p> <p>15</p> <p><b>YM15P</b> NM ..... 2501-3500 .. NF .. 1-99 .. 1-99 HM ..... 1-1200 HM ..... 2501-3500 HM ..... 4001-7350 HF ..... 1-120</p> <p><b>YM15T5</b> .. NF .. 1-99 .. 1-99 HM ..... 1-1200 HM ..... 2501-3500 HM ..... 4001-7350 HM ..... 6001-7109 NF ..... 1-1200 NM ..... 2501-3500</p> <p><b>YM15FH</b> NM ..... 2501-3500 .. NF .. 1-99 .. 1-99 HM ..... 1-1200 HM ..... 2501-3500 HM ..... 4001-7350 HF ..... 1-120</p>	 <p>P264</p> <p>145</p> <p><b>NSN11T13</b> X ..... 1-8000 X ..... 8001-9000</p> <p><b>NSN11TE</b> X ..... 1-8000 X ..... 8001-9000</p>

FOR: PER:	NISSAN					
	 <p>145</p> <p><b>NSN11AT13</b> X ..... 1-8000 X ..... 8001-9000</p>	 <p>P443</p> <p>145</p> <p><b>NSN11MH</b> X ..... 1-8000 X ..... 8001-9000</p>	 <p>145</p> <p><b>NSN11FH</b> X ..... 1-8000 X ..... 8001-9000</p>	 <p>P264</p> <p>607</p> <p><b>NSN19TE</b> ..... 1-22185 ..... 30001-37850</p>	 <p>P443</p> <p>607</p> <p><b>NSN19MH</b> ..... 1-22185 ..... 30001-37850</p>	 <p>607</p> <p><b>NSN19FH</b> ..... 1-22185 ..... 30001-37850</p>



FOR:  
PER:

# SCANIA

# STERLING

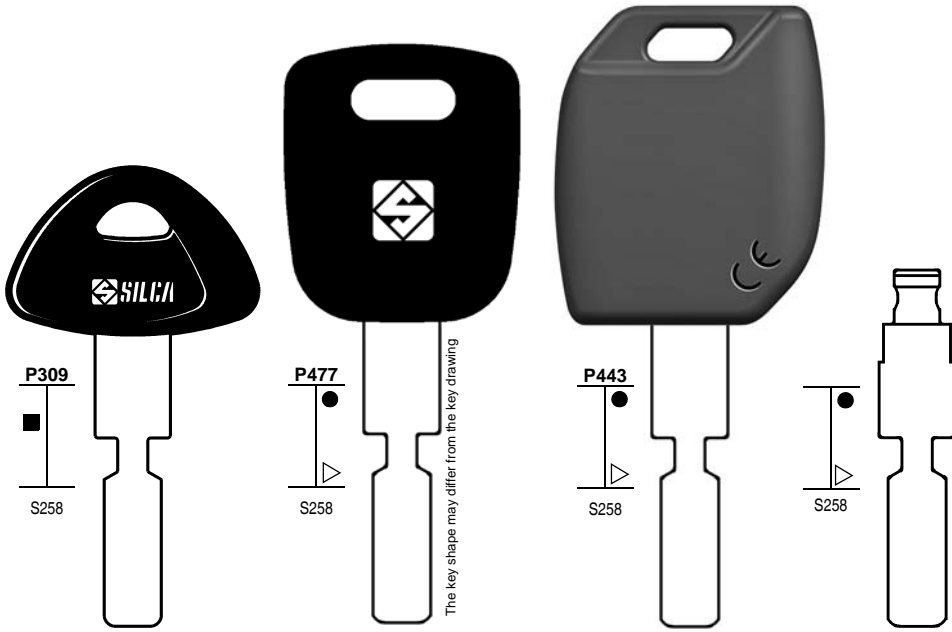

**HU71P**  
... 1-2000

**HU71TE**  
... 1-2000

**HU71MH**  
... 1-2000

**HU71FH**  
... 1-2000

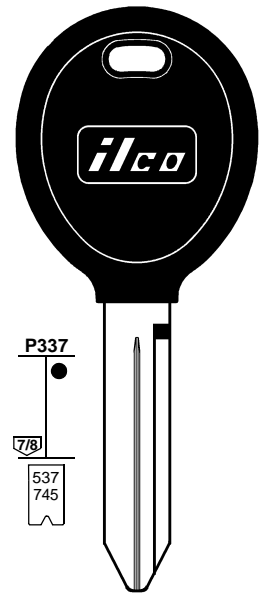

**Y164-PT**  
L ... 1-3580  
M ... 1-2618

FOR:  
PER:

# STERLING

# VOLVO









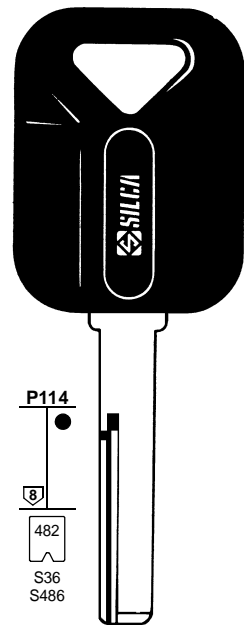









**CY24TE**  
L ... 1-3580  
M ... 1-2618

**CY24MH**  
L ... 1-3580  
M ... 1-2618

**CY24FH**  
L ... 1-3580  
M ... 1-2618  
FT ... 1001-3000



**HU56RP**  
DH ... 6001-8000  
DH ... 0001-4000

1	2	2a	3	3a	3b	e1+e2	6	42+71	72	43+44a	12	15	
						<b>GTI COMPATIBLE</b>	<b>IGNITION</b> 						
<b>MOTORCYCLE MAKE MODEL</b>	FROM	TO	SILCA REF.	SILCA REF.	SILCA REF.	COPY	GEN.	TRANSP. TYPE	FAST COPY PLUS RW4 PLUS FAST COPY/RW4	FAST COPY PLUS RW4 PLUS	FAST COPY RW4	STP	
													
For more info on the uses of truck keys, refer to the Silca Electronic Keys Catalogue: 													
<b>SCANIA</b>													
R-SERIES	2005							TEX / CR	60				
R-SERIES	2005		HU71MH	HU71TE	HU71FH	Y		TEX / CR	60	Y	P-BOX		
R144-NA	1996		HU71P		HU71FH								
164	2004							TEX / CR	60				
164	2004		HU71MH	HU71TE	HU71FH	Y		TEX / CR	60	Y	P-BOX		
SOME MODELS	1996		HU71P		HU71FH								
<b>STERLING</b>													
BULLET	2008		Y164-PT					PH / CR2	46				
BULLET	2008		CY24MH	CY24TE	CY24FH	Y	Y	PH / CR2	46	Y	P-BOX		
<b>VOLVO</b>													
FH12	1997	1997	HU56RP										





Vehicle related keys  
Chiavi veicoli - utilizzi vari  
Fahrzeugschlüssel für verschiedene Verwendungen  
Clés véhicules pour différentes utilisations  
Llaves vehículos para diferentes utilizaciones  
Chaves veícuols para utilizações várias



FOR:  
PER: **ABSA**

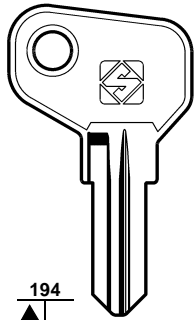

**ABS2R**



**ABUS**

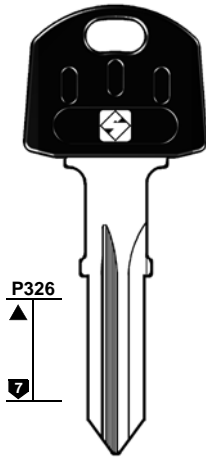

**AB57AP**

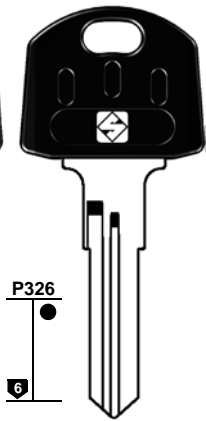

**AB64RAP**  
U72

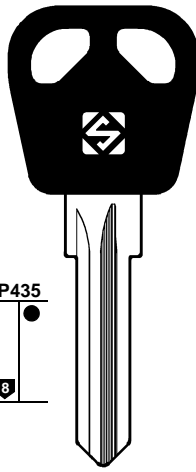

**AB82RAP**



**AB65RAP**  
W71

**ALPHA**

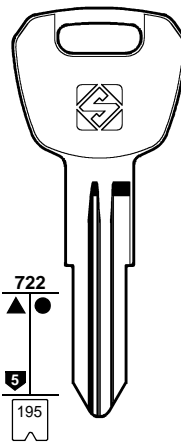

**ALP9**  
S... 301-600



**ALP9R**  
LINCE

**MONACOR - VISONIC**



**427**

FOR / PER

**ABSA (E)**

**ABUS (D)**  
BUFFO

**ADEMCO (USA)**  
YALE (434)

**ALPHA (J)**  
LINCE  
MONACOR  
VISONIC

**ASSA (S)**

**AXA (S)**

FOR:  
PER: **ASSA**

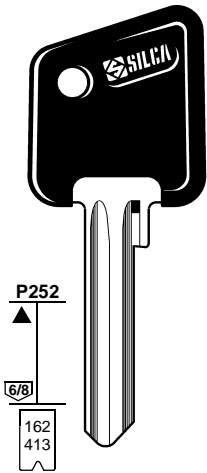

**ASS96P**

..... 6000-6999  
..... 8000-8999  
..... 9000-9999  
A..... 9000-9999



**ASS96RP**

..... 7000-7999  
A..... 7000-7999

**AXA**

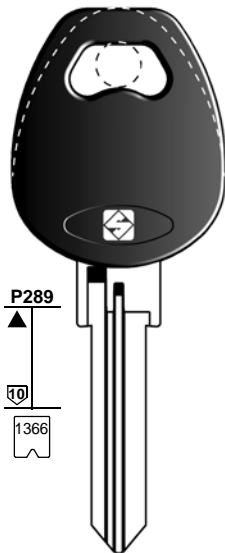

**AX1P**

..... 45015-47459  
..... 1-2-3-4

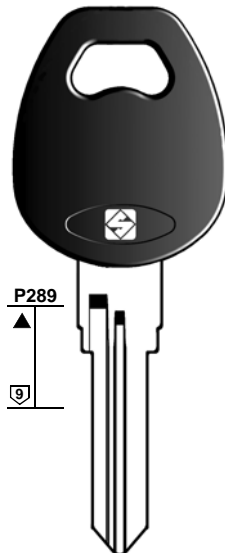

**AX1RP**

..... 35000-39999  
..... 1-2-3-4



**AX4RP**

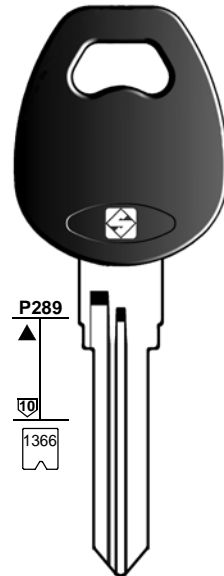

**AX5RP**

..... 1-2-3-4





# 428

FOR / PER

**BASTA** (DK)

**BENDIX** (USA)

**YALE** (434)

**BLAU** (D)

+ **HUF** (429)

**BRIGGS & S.** (USA)

**BUFFO** (GR)

**ABUS** (427)

**BULLOCK** (I)

**ZADI** (435)

**BURG** (D)

**CATERPILLAR** (USA)

**CESSNA** (USA)

PK

**CEWE** (S)

**WASO** (433)

FOR:  
PER:

## BASTA

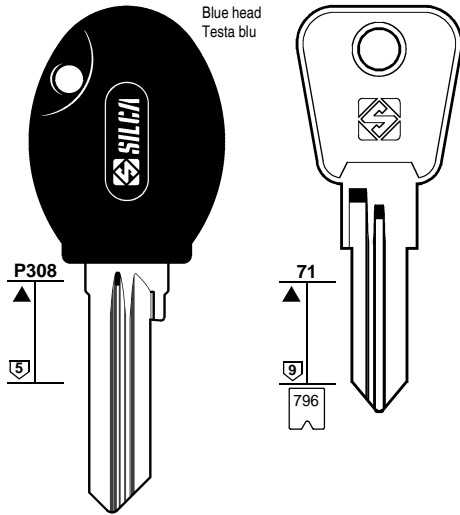

**BAS3RP**

**BAS5R**  
C ... 1-1000



## BLAU

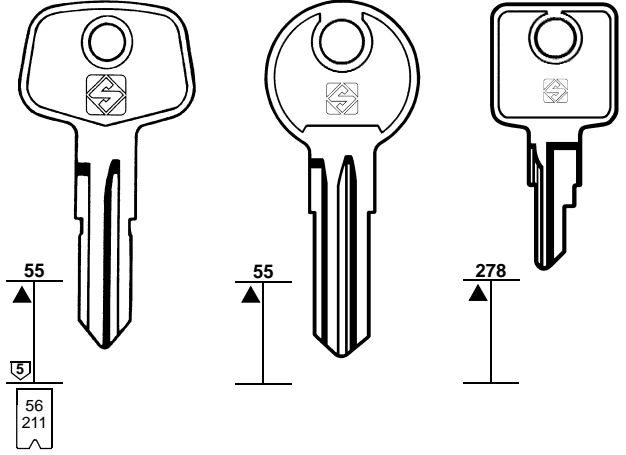

**BT2**  
... 501-598  
... 701-799  
... 626-675  
A ... 701-798

**BT2R**  
B ...  
201-225

**BT5R**

**HM1R**  
... 751-762

**HM1**  
... 778-789

... 0G1-1G0  
... G06-G10  
... 124-197  
A ... 101-125



FOR:  
PER:

## BRIGGS & S.

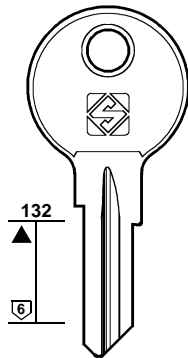

**CY12R**  
A



## BURG

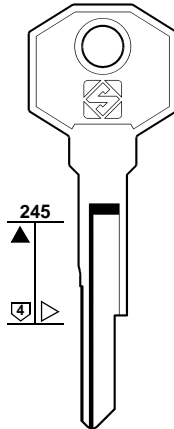

**BUR19**



## CATERPILLAR

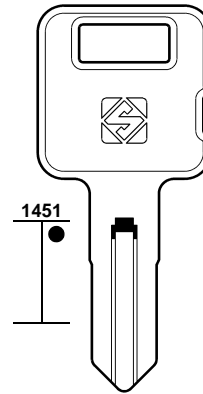

**CTR1R**



## CESSNA

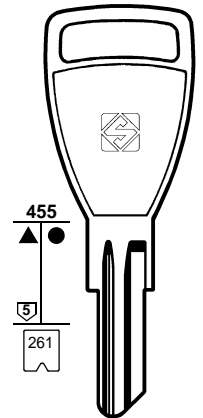

**CN1**  
PK ... 500-999

PK

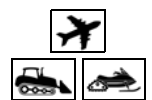

FOR:  
PER:

### CHICAGO

### EURO LOCKS

### FTH

### GIANT



# 429

FOR / PER

**CHICAGO** (USA)  
+ YALE (434)

**DUBOIS** (F)  
 LAS (430)

**EURO LOCKS** (B)  
LOWE & FLETCHER

**FEDERAL** (F)  
 FTH (429)

**FORT** (USA)  
 YALE (434)

**FTH** (F)  
FEDERAL

**GHE** (D)  
 LAPORTE (430)

**GIANT** (NL)

**GIUSSANI** (I)  
 ZADI (435)

**HARLEY D.** (USA)

**HUF** (D)  
BLAU  
NEIMAN

**ILLINOIS** (USA)  
 YALE (434)

**KOMATSU** (J)

**KIFERM** (F)  
 LAS (430)

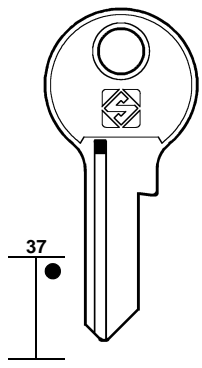

**CH10**

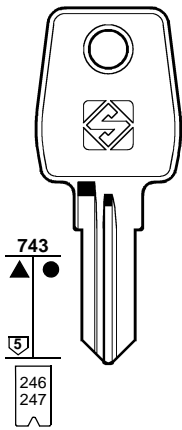

**LF23R**  
93 ... 401-900  
... 1001-1100  
... 9001-9500  
EL ... 9001-9500  
EL ... 1-500

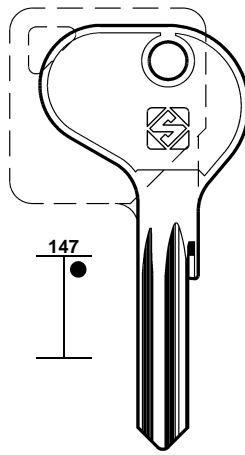

**FH24R**

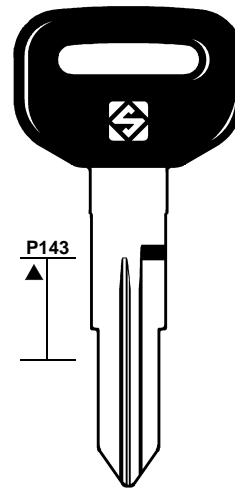

**GNT1P**



FOR:  
PER:

### HARLEY D.

### HUF

### KOMATSU

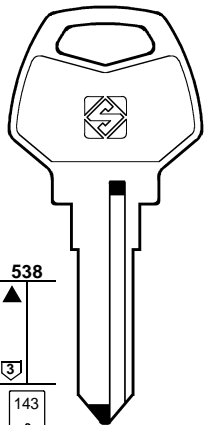

... 43-118

**HY5**      
**HY5R**  
  
**HY6**  
  
**HY7**      
**HY7R**

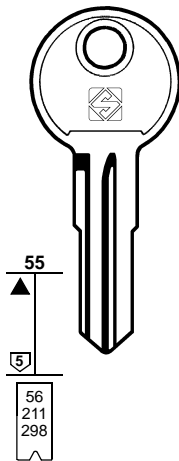

**VO12**  
N ... M 1-200  
... G06-G10  
... 701-799  
A ... 701-798  
... 626-675  
... 501-598  
A ... 101-125  
N ... 1-200  
... 1-200  
G ... 1-100  
... 0G1-1G0  
... 124-197



**BLAU - NEIMAN**

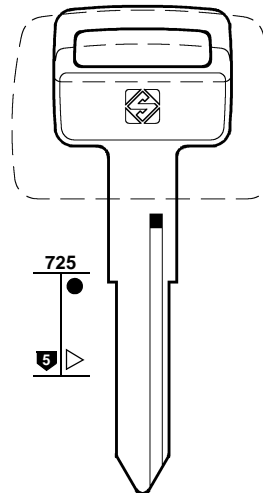

**KOM1**





# 430

FOR / PER

**KUBOTA (J)**

**LAPORTE (D)**

GHE  
PRESTA

**LAS (F)**

DUBOIS  
KIFERM  
PK

**LINCE (E)**

ALPHA (427)

**LOWE & F. (GB)**

+ EURO LOCKS (429)

**LUMA (E)**

**MAHINDRA (IND)**

FOR:  
PER:

**KUBOTA**

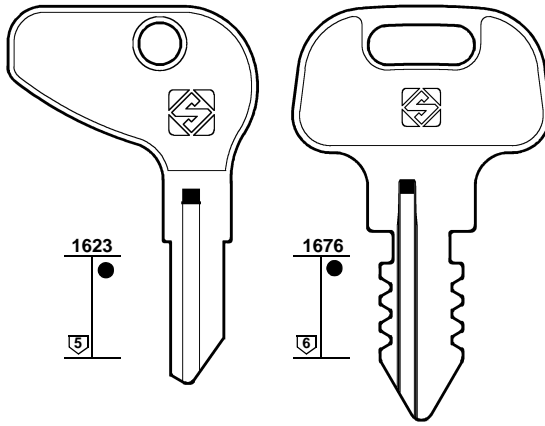

**KUB1R**  
... 1234

**KUB2R**



**LAPORTE**

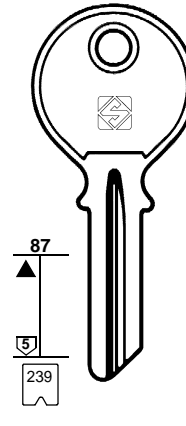

**LAP1**  
... 7200-7399  
... 1001-1052



GHE - PRESTA

**LAS**

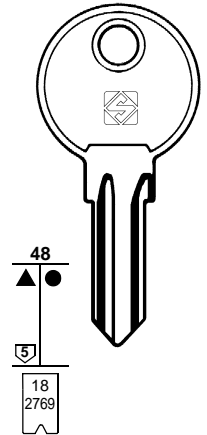

**LS1**  
R... 1-224



DUBOIS - KIFERM - PK

FOR:  
PER:

**LOWE & FLETCHER**

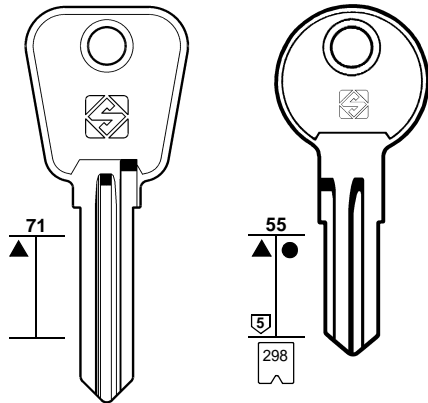

**LF44**

**LF12**  
... 1-200  
89... 1-200



**LUMA**

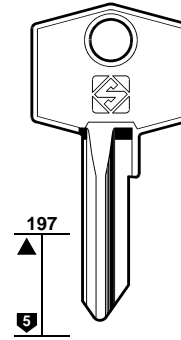

**LM2**



**MAHINDRA**

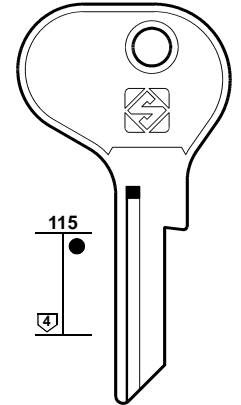

**MHN1**



FOR:  
PER:

### MERIT

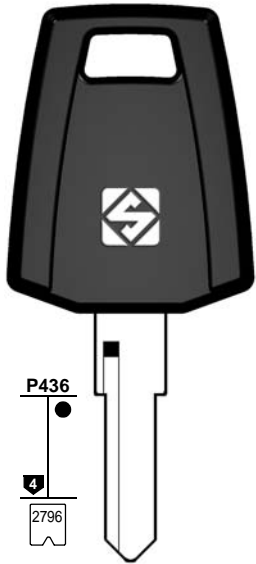

P436  
4  
2796

**MRT2RAP**  
... C/D 001-050



### MERONI

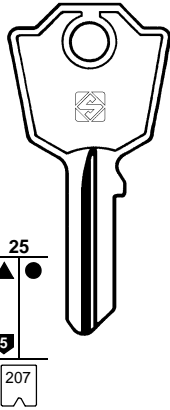

25  
5  
207

**MER4**  
G ... 3001-3480  
... 3001-3480  
G ... 0-479



### NEIMAN

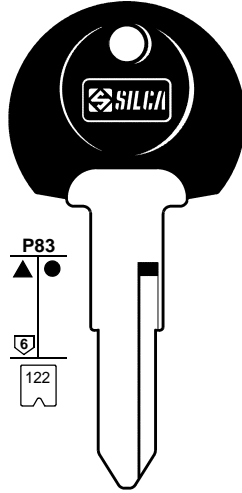

P83  
6  
122

**NE76AP**  
... 0/9 ... 0/90/9  
M-N-P-R-S

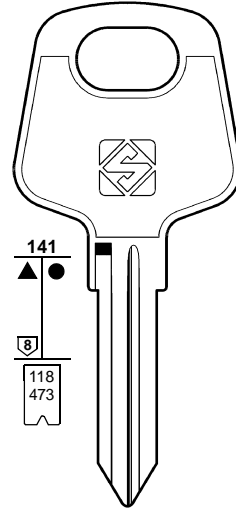

141  
8  
118  
473

**NE19**  
GM ... 2001-3000  
... 2001-4949



# 431

FOR / PER

**MERIT** (D)

**MERONI** (I)

**MONACOR** (PRC/CN)  
👁️ ALPHA (427)

**NEIMAN** (D) (F)  
+ 👁️ HUF (429)

**PK** (F)  
👁️ CESSNA (428)  
👁️ LAS (430)

**POS** (D)  
👁️ SISPA (431)

**PRESTA** (D)  
👁️ LAPORTE (430)

**RONIS** (F)

**SISPA** (I)  
POS

FOR:  
PER:

### RONIS

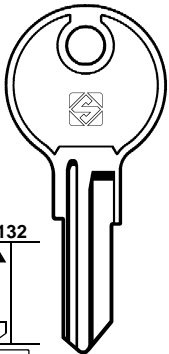

132  
5  
1469

**RO49**  
CH ... 101-751  
GZ ... 101-751



### SISPA

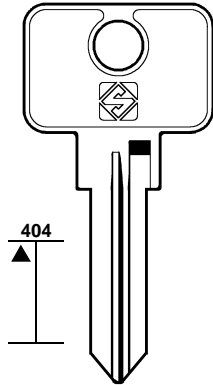

404

**SSA4**

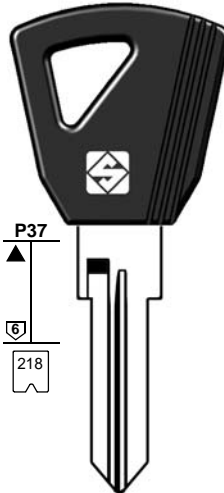

P37  
6  
218

**SSA4RAP**  
... 1-200

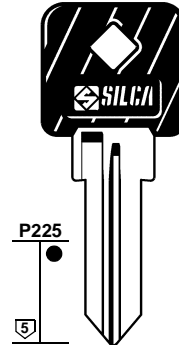

P225  
5

**SSA6RP**



POS



# 432

FOR / PER

STAHLEX (D)

STARRY (NL)

TOK (D)

WASO (433)

TRELOCK (D)

+ WASO (433)

FOR:  
PER:

## STAHLEX

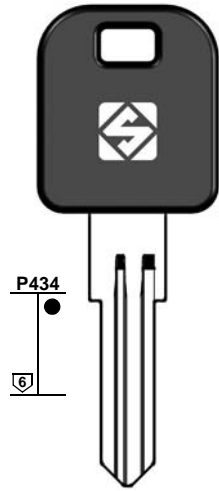

STH1P



STH1RP



## STARRY

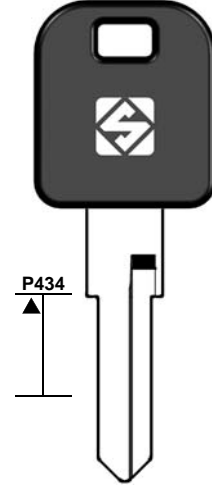

STY1P



FOR:  
PER:

## TRELOCK

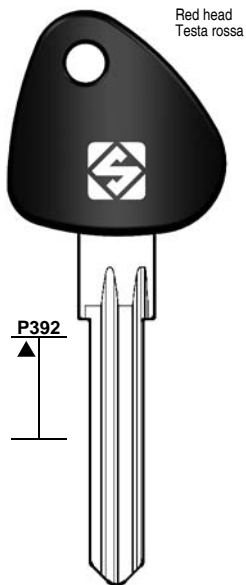

TRK7P

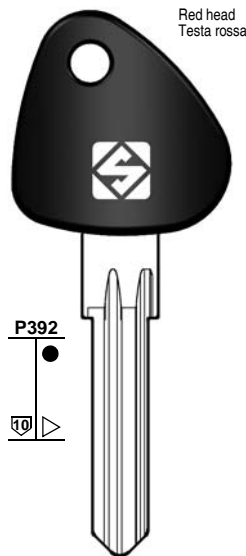

TRK6P

..... 123

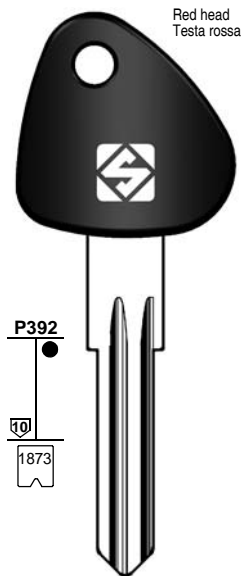

TRK5P

R6 .....  
40000-46941

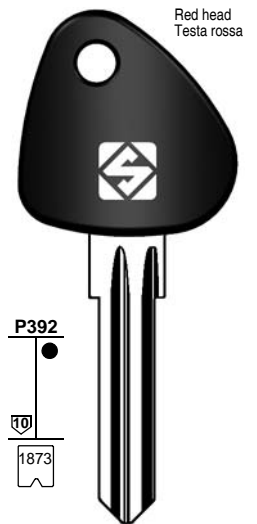

TRK1P

R6 .....  
0-1-2





FOR:  
PER:

# TRELOCK

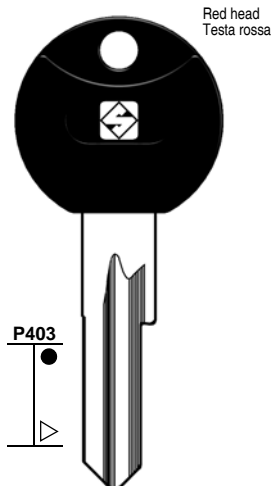

**TRK2RAP**

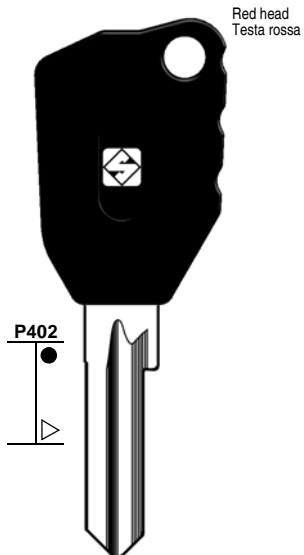

**TRK3RBP**

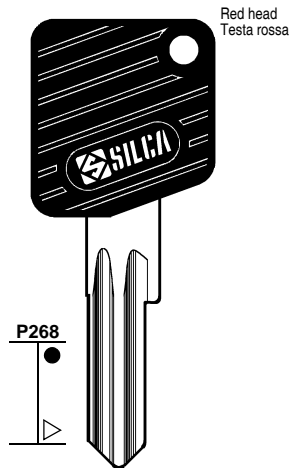

**TRK4CP**



WASO



# 433

FOR / PER

**TRELOCK (D)**  
WASO  
+ WASO (433)

**VISONIC (PRC/CN)**  
 ALPHA (427)

**WASO (D)**  
CEWE  
TOK  
TRELOCK  
+ TRELOCK (433)

FOR:  
PER:

# WASO

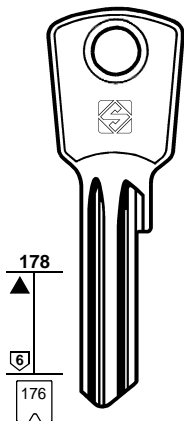

**WAS2**  
L..... 012345

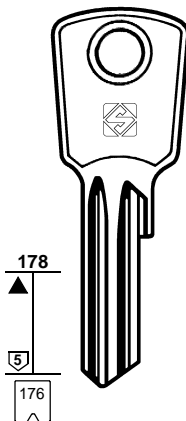

**WAS3**  
Z..... 012345  
B..... 012345  
H..... 012345

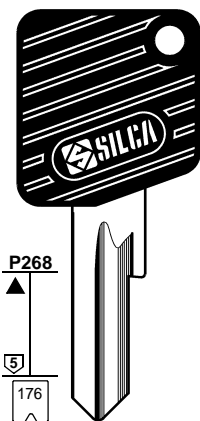

**WAS3RBP**  
Z..... 012345  
B..... 012345  
H..... 012345

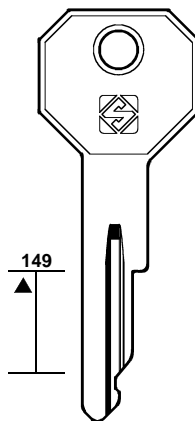

**WAS14R**

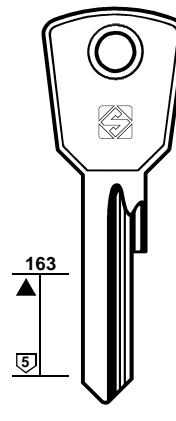

**WAS4**



TOK



TOK



TRELOCK



CEWE





# 434

FOR / PER

**WILK** (D)

**YALE** (USA)

ADEMCO  
BENDIX  
CHICAGO  
FORT  
ILLINOIS

**YAMAHA** (J)

**YANMAR** (J)

**YWS** (TW)

FOR:  
PER:

### WILK

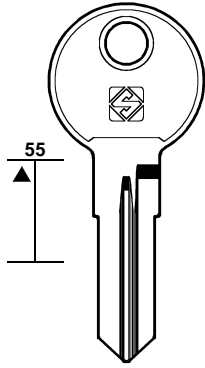

**WIK1**



**WIK1R**



### YALE

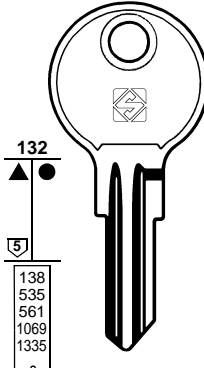

**YA4**

KC ... 251-500  
T ... 501-750  
VB ... 501-750

HK ... 001-202  
... V 0001-0300  
C ... 001-250  
... 010-225



**YA4R**

CH ... 251-750



**YA18**

... 600-650  
... 500-550  
... 1250-1499  
FL ... 201-240  
CG ... 1-54  
CR ... 1-35  
GR ... 001-200  
LC ... 1-100  
LL ... 226-450  
HMV ... 1-26  
UM ... 226-425



**ADEMCO - BENDIX - CHICAGO  
FORT - ILLINOIS**

### YAMAHA

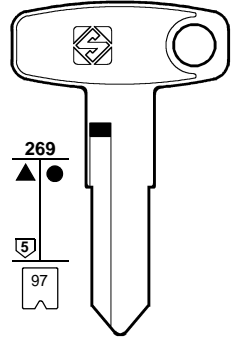

**YH21R**

... 451-470  
... 4301-4350  
... 3351-3400  
... 3101-3150



FOR:  
PER:

### YANMAR

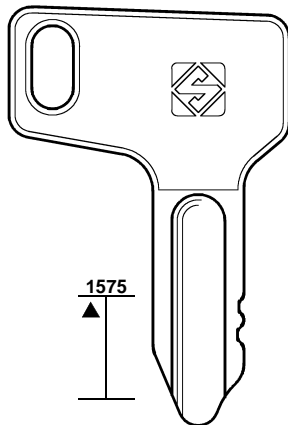

**YAR2**



### YWS

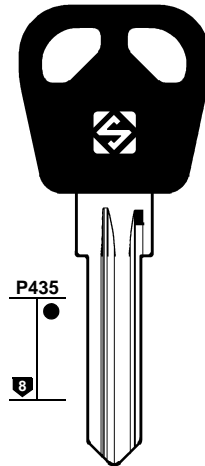

**YW1P**



FOR:  
PER:

# ZADI

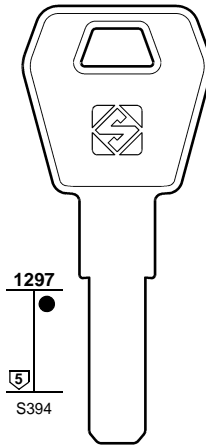
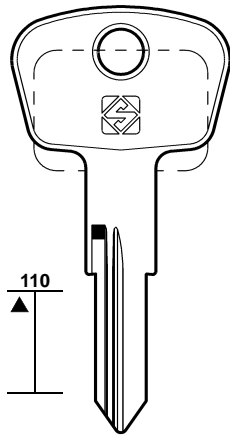

# 435

FOR / PER

ZADI (1)  
BULLOCK  
GIUSSANI

  
ZD18

  
ZD18R



  
ZD25



BULLOCK - GIUSSANI

FOR:  
PER:



General index  
Indice generale  
Generalverzeichnis  
Index général  
Indice general  
Índice geral



Ref.	Page
<b>A</b>	
AX4RP	427
AX5RP	427
<b>B</b>	
B97-PT	18, 20, 40, 246, 286, 304
B97-PT5	18, 20, 40, 246, 286
B98-PT	18, 246, 286
B98-PT5	18, 246, 286
B99-PT	18, 20, 40, 246, 284, 286
B99-PT5	18, 20, 40, 246, 284, 286
B100-PT	18, 20, 40, 246, 284
B100-PT5	18, 20, 40, 246, 284
B103-PT	284
B103-PT5	284
B104-PT	284
B104-PT5	284
B111-PT	18, 20, 22, 30, 32, 34, 36, 38, 40, 112, 130, 284, 286, 304, 340
BAS3RP	428
BAS5R	428
BAJ1RP	378
BT2	428
BT2R	428
BT5R	428
BUR19	428
BW7BP	380
BW9FH	380
BW9MH	380
BW9TE	380

Ref.	Page
<b>C</b>	
CG1P	382
CG2RP	382
CH9T	386
CH10	429
CN1	428
CTR1R	428
CY12R	428
CY16P	52
CY19P	52
CY22P	50, 52, 68, 282
CY23	52, 66, 282
CY24	50, 52
CY24BP	50, 52, 66, 68
CY24FH	50, 52, 66, 68, 70, 162, 226, 282, 422
CY24MH	50, 52, 66, 68, 70, 162, 226, 282, 422
CY24TE	50, 52, 66, 68, 70, 162, 226, 282, 422
<b>D</b>	
DAT12	314
DAT12BP	314
DAT12CP	314
DAT12R	36, 314
DAT17FH	312, 316, 318, 320
DAT17MH	312, 316, 318, 320
DAT17T13	318, 320
DAT17T21	312, 316, 318, 320
DAT17TE	312, 316, 318, 320
DH4R	282
DH4RP	282
DH4RT4	64
DH5RFH	64
DH5RMH	64

Ref.	Page
DH5RP	64
DH5RT4	64
DH5RTE	64
DWO4CT6	38, 46, 48
DWO4R	48
DWO4RAP	30, 38, 48, 328, 334
DWO4RFH	30, 38, 42, 44, 48, 118, 284, 328, 334
DWO4RMH	44, 48
DWO4RT5	30, 48
DWO4RT6	42, 44, 48, 118, 284
DWO4RTE	44, 48
DWO5AP	46, 338
DWO5FH	32, 34, 44, 46, 250, 304, 338
DWO5MH	32, 44, 250, 304
DWO5R	46
DWO5RAP	46
DWO5RT5	40, 44
DWO5T5	34, 46
DWO5T6	46
DWO5TE	250, 304
DWO6BT5	46
DWO6BT6	46
DWO7BP	48
<b>E</b>	
EK3P-GM45	120, 284
EK3P-HO03	124, 128
EK3P-MIT16	222
EK3P-Y170	50, 52, 66, 68, 162, 368
<b>F</b>	
FH24R	429
FO10FH	98
FO10MH	98
FO10T7	98
FO10TE	98



Ref.	Page
FO19FH	196
FO19MH	196
FO19TE	196
FO21AP	90
FO21FH	84, 86, 90, 92, 96, 98, 110, 162, 208
FO21MH	84, 86, 90, 92, 96, 98, 110, 162, 208
FO21P	144, 208
FO21T17	90, 110
FO21T3	82, 90, 92, 96, 98, 162,
FO21T3M	90, 92, 96, 98
FO21T7	84, 86, 90, 92, 96, 98, 144, 162
FO21TE	84, 86, 90, 92, 96, 98, 110, 162, 208
FO22R	106, 108
FO22RP	106, 108
FO26FH	102, 214, 216
FO26MH	102, 214, 216
FO26T3	102, 106, 214, 216
FO26TE	102, 214, 216
FO32R	108
FO32RAP	108
FO34	84
FO34AP	84
FO35	100
FO37R	102
FO38RFH	82, 84, 86, 88, 100, 102, 104, 106, 108, 110, 202, 214, 216, 418
FO38RMH	82, 84, 86, 88, 100, 102, 104, 106, 108, 110, 202, 214, 216, 418
FO38RT17	82, 86, 98, 100, 102, 104, 106, 108, 110, 202, 210, 212, 214, 216
FO38RT3	82, 86, 98, 100, 102, 104, 106, 108, 110, 202, 210, 214, 216, 418
FO38RTE	82, 84, 86, 88, 100, 102, 104, 106, 108, 110, 202, 214, 216, 418
FO39	102, 108, 214, 216

Ref.	Page
FO39CP	102, 108, 214, 216
FO40R	82, 86, 100, 104, 108, 110, 216
FO40RBP	82, 86, 100, 104, 108, 110, 216
FO6	130
<b>G</b>	
GM15T5	120, 158, 256
GM18R	36, 40
GM19	36, 112
GM19P	156
GM27R	18
GM30AP	340
GM39	20, 30, 32, 34, 36, 40, 130, 246, 286
GM39EP	20, 30, 32, 36, 40, 112, 156, 246, 284
GM40	30, 32, 34, 36, 40
GM40EP	30, 32, 36, 40, 286
GM41	144
GM44RP	28
GM45FH	32, 120, 284
GM45MH	32, 120, 284
GM45TE	32, 120, 284
GM5	18, 36
GM5-OR	18, 36, 42
GM5CP	18, 36, 42
GNT1P	429
GT10BT5	58, 60, 72, 74, 276
GT10BTE	58, 60, 72, 74, 160, 276
GT10FH	58, 60, 72, 74, 160, 276
GT10MH	160
GT10P	58
GT15RAP	12
GT15RAT5	70, 72, 74
GT15RBT5	70, 72, 74, 78, 80
GT15RBTE	78, 194
GT15RCP	74
GT15RCT5	70, 74

Ref.	Page
GT15RDP	402
GT15RDT5	402
GT15RFH	12, 14, 70, 72, 74, 78, 80, 194, 402
GT15RMH	12, 14, 78, 194, 402
GT15RP	402
GT15RT2	12
GT16T2	12
GT18RT5	190, 192
GT20RDP	382, 402
<b>H</b>	
H72-EK3	418
H72-EK3	102, 104, 106, 108, 110, 202, 210, 214, 216
H74-PT	110, 144, 202
H82-PT	202, 214
H86-PT	82, 84, 86, 88, 104, 106, 212
HD107-PT5	8, 126, 128
HM1	428
HM1R	428
HON31	386, 392, 398
HON31CP	386, 392, 398
HON31R	386, 392
HON31RCP	386, 392
HON41	388, 390
HON41P	388, 390
HON58R	156
HON58RFH	8, 10, 120, 124, 126, 128, 156, 256, 388
HON58RMH	8, 10, 388
HON58RT5	8, 124, 126, 128
HON58RT6	120, 124, 126, 144, 256
HON58RTE	8, 10, 388
HON59R	156
HON63FP	386, 388, 390
HON64	388
HON64BP	388, 392
HON64R	392
HON64RBP	388, 392



**GENERAL INDEX - INDICE GENERALE - GENERALVERZEICHNIS - INDEX GÉNÉRAL INDICE GENERAL - ÍNDICE GERAL**

Ref.	Page
HON65RT6	124
HON66FH	8, 10, 124, 126, 128
HON66MH	8, 10, 124, 126, 128
HON66T14	8, 10, 124, 126, 128
HON66T27	124, 126, 128
HON66T5	8, 124, 128
HON66T6	124, 126
HON66TE	8, 10, 124, 126, 128
HON68BP	392
HON68RBP	392
HON70FH	386, 388, 390
HON70MH	386, 388, 390, 392
HON70T14	386, 388, 390, 392
HON70TE	386, 388, 390, 392
HON71CP	386
HON71RCP	386
HON72P	392
HOV01T5	128
HU100BT12	118, 248, 254, 256, 264
HU100FH	18, 20, 22, 24, 30, 34, 36, 38, 42, 44, 46, 48, 112, 114, 122, 248, 252, 254, 256, 260, 264, 266, 268, 302
HU100MH	18, 20, 22, 24, 30, 34, 36, 38, 42, 44, 46, 48, 112, 114, 122, 248, 252, 254, 256, 260, 266, 268, 302
HU100T12	248, 254, 256, 264
HU100T32	254
HU100TE	18, 20, 22, 24, 30, 34, 36, 38, 42, 44, 46, 48, 112, 114, 122, 248, 252, 254, 256, 260, 266, 268, 302
HU101AP	86
HU101FH	82, 88, 90, 92, 94, 96, 100, 194, 196
HU101MH	82, 88, 90, 92, 94, 96, 100, 194, 196
HU101T17	86, 90, 92, 94, 96, 100
HU101T20	82, 86, 102
HU101TE	82, 88, 90, 92, 94, 96, 100, 194, 196
HU109FP	302
HU133RFH	78, 206, 208, 238, 248, 324, 330, 332, 334, 336, 338

Ref.	Page
HU133RMH	78, 206, 208, 238, 248, 324, 330, 332, 334, 336, 338
HU133RT12	78, 206, 248, 334, 338
HU133RT14	78, 204, 206, 208, 238, 248, 324, 334, 336, 338
HU133RT18	332
HU133RTE	78, 206, 208, 238, 248, 324, 330, 332, 334, 336, 338
HU134FH	190
HU134MH	190
HU134TE	190
HU136FH	300
HU136MH	300
HU136TE	300
HU137KP	374
HU137TEK	374
HU160GP	24, 26
HU43AT9	122, 264, 268
HU43FH	28, 122, 252, 258, 260, 262, 264, 266, 268
HU43MH	260, 266
HU43T2	28, 122, 252, 258, 262, 264, 268
HU43T9	122, 264, 268
HU43TE	260, 266
HU46	116
HU46AT12	114, 250, 252, 262, 264, 268
HU46AT5	42, 44, 46
HU46AT9	26, 28, 114, 116, 250, 254, 258, 262
HU46BT12	26, 118, 254, 256
HU46FH	20, 24, 26, 28, 114, 116, 118, 250, 252, 254, 258, 260, 262, 264, 268
HU46P	116
HU46T12	24, 26, 28, 114, 250, 252, 254, 262, 264, 268
HU46T2	20, 24, 26, 28, 114, 116, 118, 144, 250, 252, 254, 260, 262

Ref.	Page
HU46T9	26, 28, 114, 116, 250, 254, 258, 262
HU49AT5	14
HU49EP	372
HU49FH	14, 306, 366, 368, 370, 372
HU49RCP	372
HU49REP	372
HU49RT6	368, 372
HU49T10	366, 370
HU49T10X	370
HU49T28	366, 370
HU49T5	306, 366, 368, 370
HU56RAT2	374
HU56RFH	218, 220, 308, 374
HU56RMH	220, 308
HU56RP	422
HU56RT2	218
HU56RT30	218
HU56RTE	220, 308
HU66AT5	14, 306, 308
HU66AT6	14, 306
HU66BT1	92
HU66BT28	92
HU66CT5	306, 368
HU66CT6	368
HU66DT5	92
HU66FH	14, 92, 288, 306, 308, 366, 368, 370, 372
HU66MH	14, 288, 368, 370
HU66T10	92, 306, 368, 370
HU66T23	306
HU66T24	366, 368, 370, 372
HU66T26	308
HU66T28	306, 366, 368, 370
HU66T5	288, 306, 368, 370
HU66T6	14, 306, 308, 366, 368, 370, 372
HU66TE	14, 288
HU70EP	372



Ref.	Page
HU70T6	370, 372
HU71FH	422
HU71MH	422
HU71P	422
HU71TE	422
HU72RP	212
HU83FH	56, 60, 76, 80, 192, 270, 274, 278, 280, 420
HU83MH	56, 60, 76, 80, 192, 270, 274, 278, 280
HU83T	144, 282, 420
HU83T14	56, 60, 76, 80, 192, 270, 274, 276
HU83T5	420
HU83TE	56, 60, 76, 80, 192, 270, 274, 278, 280
HU87RFH	248, 314, 330, 332, 340
HU87RMH	314, 330
HU87RT12	248
HU87RT18	314, 330
HU87RT5	248, 332, 340
HU87RT9	330, 340
HU87RTE	314, 330
HU92RKP	16
HU92RTEK	16
HU92RMH	16, 196
HU92RTE	16
HY5	429
HY5R	429
HY6	429
HY7	429
HY7R	429
HY11R	386
HYN10	130, 136
HYN10BP	130, 132, 136, 310
HYN10FH	130, 132, 136, 144, 152
HYN10MH	130, 132, 136, 144, 152
HYN10T14	132
HYN10T4	130, 132, 136, 144, 152
HYN10TE	130, 132, 136, 144, 152
HYN11	136, 142

Ref.	Page
HYN11CP	132, 136, 142, 150
HYN12CP	150
HYN12FH	150
HYN12MH	150
HYN12T4	150
HYN12TE	150
HYN13BP	154
HYN14FH	136, 140, 166, 176, 184
HYN14MH	136, 140, 166, 176, 184
HYN14RFH	134, 138, 140, 146, 148, 152, 168, 170, 182, 188
HYN14RMH	134, 138, 140, 146, 148, 152, 168, 170, 182, 188
HYN14RT14	134, 138, 144, 148, 152, 168, 170, 182, 186
HYN14RTE	134, 138, 140, 146, 148, 152, 168, 170, 182, 188
HYN14T14	136, 140, 166, 176, 184
HYN14TE	136, 140, 166, 176, 184
HYN15FH	178
HYN15MH	178
HYN15T14	178
HYN15TE	178
HYN6FH	132, 134, 138, 140, 142, 144, 146, 150, 154, 172, 176, 190
HYN6MH	132, 134, 138, 140, 142, 144, 146, 150, 154, 172, 176, 190
HYN6P	180
HYN6T14	130, 134, 138, 140, 142, 144, 150, 154, 172, 176, 188
HYN6T4	134, 138, 140, 142, 146
HYN6TE	132, 134, 138, 140, 142, 144, 146, 150, 154, 172, 176, 190
HYN7R	146, 148
HYN7RAP	146, 148, 154, 176, 186
HYN7RFH	140, 144, 148, 150, 154, 186
HYN7RMH	140, 144, 148, 150, 154, 186

Ref.	Page
HYN7RT14	186
HYN7RT4	146, 148
HYN7RTE	186
HYN8R	146, 148
HYN9P	150
<b>I</b>	
ISU5MH	418
<b>K</b>	
KIA1R	84, 184, 188
KIA1RAP	184
KIA1RP	84, 188
KIA2R	190
KIA3R	164, 166, 168, 178, 184, 186
KIA3RAP	166, 180, 184
KIA3RFH	164, 166, 168, 170, 172, 174, 178, 182, 184, 188
KIA3RMH	164, 166, 170, 172, 174, 178, 182, 184, 188
KIA3RT14	164, 166, 170, 172, 174, 182, 184
KIA3RT16	164, 166, 170, 178, 180, 184, 188
KIA3RT5	168, 184, 188
KIA3RTE	164, 166, 170, 172, 174, 178, 182, 184, 188
KIA3T5	168,
KIA4RBP	164
KIA5	190
KIA7T14	134, 138, 142, 164, 168, 176, 182, 186
KOM1	429
KUB1R	190, 430
KUB2R	430
KW12	394, 396
KW12BP	394, 396
KW14	380, 382, 384



Ref.	Page
KW14AP	394, 396
KW14FH	380, 382, 384, 394, 396
KW14MH	394, 396
KW14P	380, 382, 384
KW14R	394, 396
KW15BP	394, 396
KW16CP	394, 396
KW16FH	394, 396
KW16MH	394, 396
KW16TE	394, 396
KW17T5	382, 384
KW18DP	396
KYM1P	398
KYM1RP	398
KYM2	398
KYM2P	398
KYM2R	398
<b>L</b>	
LAP1	430
LD6RP	190
LF12	430
LF23R	429
LF44	430
LM2	430
LS1	430
<b>M</b>	
MAZ13T5	96, 210
MAZ20REP	210
MAZ20RT5	210, 212
MAZ24RFH	210
MAZ24RMH	210
MAZ24RT17	210
MAZ24RT5	210
MAZ24RTE	210
MAZ25R	212

Ref.	Page
MER4	431
MHN1	430
MIT11RFH	56, 218, 220, 222, 224, 226, 274, 278
MIT11RMH	56, 218, 220, 222, 224, 226, 274, 278
MIT11RT19	222, 224, 226
MIT11RT21	224
MIT11RT4	220, 222, 224, 226
MIT11RTE	56, 218, 220, 222, 224, 226, 274, 278
MIT14BT14	224, 226, 228
MIT14BT5	212, 224, 226, 228
MIT15AP	144, 218, 418
MIT8AP	222
MIT8FH	220, 222, 224, 226
MIT8MH	220, 222, 224, 226, 228
MIT8-PT	218, 220, 222, 224, 226, 228
MIT8T19	220, 222, 224, 226, 228
MIT8T21	220, 224, 226
MIT8T4	220, 222, 224, 226, 228
MIT8TE	220, 222, 224, 226, 228
MIT9-PT	220, 222
MRT2RAP	431
<b>N</b>	
NE19	431
NE20NP	190, 228, 374
NE38P	218
NE51T2	374
NE66T2	374
NE72AT14	270
NE72AT29	270
NE72AT5	270
NE72ATE	232, 240, 258, 266, 290, 294, 296, 300
NE72FH	232, 240, 258, 266, 270, 290, 294, 296, 300
NE72GP	298

Ref.	Page
NE72LP	54, 62
NE72MH	232, 240, 258, 266, 290, 294, 296, 300
NE73	290
NE73-BI	282, 298
NE73-CI	282, 298
NE73DP	290
NE73FH	230, 232, 252, 256, 270, 288, 290, 292, 294, 296, 418
NE73MH	232, 256, 270, 288, 294, 296
NE73T16	288, 296
NE73T32	230, 240, 256, 266, 292, 296
NE73T5	230, 252, 256, 288, 290, 292, 296
NE73T6	418
NE73T8	296
NE73TE	232, 256, 270, 288, 294, 296
NE73TP	298
NE74P	400
NE74T5	400
NE75EP	194
NE75FH	194, 196
NE75MH	196
NE75TE	196
NE76AP	431
NE77RDP	124, 302
NE77RT2	124, 302
NE78MH	272
NE78P	272
NE78T14	272
NE78T29	272
NE78T5	272
NE78TE	272
NE92P	418
NI01T	230, 244
NI02T	156, 228, 230, 236, 242, 244, 246
NSN11AT13	234, 242, 420
NSN11AT25	232, 234, 236, 242



Ref.	Page
NSN11FH	96, 156, 232, 234, 236, 240, 242, 244, 314, 316, 318, 420
NSN11MH	234, 242, 420
NSN11T	322
NSN11T13	234, 242, 420
NSN11T2	96, 156, 232, 234, 236, 240, 242, 244, 314, 316, 318
NSN11T25	234, 236, 242
NSN11TE	234, 236, 242, 420
NSN14	230, 236
NSN14AT13	230, 234, 238, 240, 242
NSN14AT25	228, 234, 238, 240, 242
NSN14CP	230, 236
NSN14FH	156, 230, 232, 234, 238, 240, 242, 244, 246, 312, 314, 318, 320, 326
NSN14MH	156, 230, 232, 234, 238, 240, 242, 244, 246, 312, 314, 318, 320, 326
NSN14T	322
NSN14T13	230, 234, 238, 240, 242, 312, 314, 318, 320
NSN14T14	156, 244, 246, 326
NSN14T25	230, 234, 238, 240, 242
NSN14T5	240
NSN14TE	156, 230, 232, 234, 238, 240, 242, 244, 246, 312, 314, 318, 320, 326
NSN15	230, 236
NSN16R	242
NSN16RBP	242
NSN19	322
NSN19FH	294, 312, 316, 318, 320, 322, 420
NSN19MH	294, 310, 312, 316, 318, 320, 420
NSN19T13	312, 316, 318, 320
NSN19T21	310, 312, 316
NSN19TE	420
NSN19TE	294, 310, 312, 316, 318, 320

Ref.	Page
<b>P</b>	
PO1RFH	288
PO1RMH	288
PO1RT4	288
PO1RTE	288
<b>R</b>	
RO49	431
RR2	302
RR2P	302
<b>S</b>	
SIP16FH	12, 192
SIP16MH	12
SIP16T2	192
SIP16TE	12
SIP18T	14, 194
SIP22FH	8, 12, 58, 60, 70, 72, 74, 76, 94, 160, 192, 274, 276, 384, 402
SIP22KP	194
SIP22TEK	194
SIP22LP	78
SIP22MH	8, 12, 60, 70, 72, 74, 76, 94, 160, 192, 274
SIP22T5	384, 402
SIP22TE	8, 12, 58, 60, 70, 72, 74, 76, 94, 160, 192, 274, 276
SIP29T	14, 194
SIP36MH	12, 58, 74, 276
SK22RBP	306, 308
SK22RT1	306, 308
SSA4	431
SSA4RAP	431
SSA4RP	431
SSY1P	310
SSY2AP	310

Ref.	Page
SSY3	310
SSY3FH	310
SSY3MH	310
SSY3TE	310
STH1P	432
STH1RP	432
STY1P	432
SX9AP	10, 16, 22, 60, 162, 200, 218
SX9CP	54, 58, 62, 76, 80, 192, 272, 276, 278, 280
SX9GP	54, 62, 278, 280
SX9MH	54, 56, 58, 62, 76, 276, 278, 280
SX9T14	54, 56, 58, 60, 62, 76, 276, 278, 280
SX9T5	54, 58, 60, 62, 76, 80, 192, 272, 276, 278, 280
SX9T6	62
SX9TE	54, 56, 58, 62, 76, 276, 278, 280
SZ4	382
SZ4AP	382
SZ10R	404, 406
SZ10RP	404, 406
SZ11	204
SZ11FH	204, 324
SZ11MH	204, 324
SZ11P	204
SZ11R	340
SZ11RFH	208, 324, 326, 328, 332, 336, 340
SZ11RMH	208, 324, 326, 328, 332, 336, 340
SZ11RP	322, 340
SZ11RT18	208, 324, 330, 332
SZ11RT4	322, 326, 328, 332, 334, 340
SZ11RT5	332
SZ11RTE	208, 324, 326, 328, 332, 336, 340
SZ11T18	204, 324
SZ11TE	204, 324
SZ12	116, 324



**GENERAL INDEX - INDICE GENERALE - GENERALVERZEICHNIS - INDEX GÉNÉRAL INDICE GENERAL - ÍNDICE GERAL**

Ref.	Page
SZ12FH	158, 316, 322, 326, 328, 336, 340
SZ12MH	158, 316, 322, 326, 328, 336, 340
SZ12P	116, 158, 324
SZ12T4	316, 322, 324, 326, 328, 334, 338
SZ12TE	158, 316, 322, 326, 328, 336, 340
SZ14RAP	394, 404, 406, 408
SZ17RFH	406, 408
SZ17RMH	406, 408
SZ17RTE	406, 408
SZ18FH	204
SZ18MH	204
SZ18RFH	206
SZ18RMH	206
SZ18RTE	206
SZ18TE	204
SZ19P	206
SZ19RP	204
SZ20P	204
SZ21RP	206, 208
SZ22FH	330, 334, 338
SZ22MH	330, 334, 338
SZ22TE	330, 334, 338
SZ24RAT22	414
SZ24RTE	390, 410, 414
SZ24RMH	390, 410,
<b>T</b>	
TAT1FH	342
TAT1MH	342
TAT1P	342
TAT1TE	342
TAT2P	342
TAT3RP	342
TBE1T5	162
TOY38RP	348

Ref.	Page
TOY40BT4	198, 200, 346, 350, 358
TOY40BTE	198, 200, 224, 228, 346, 350, 358
TOY40FH	134, 138, 142, 164, 168, 174, 178, 182, 186, 198, 200, 224, 228, 346, 350, 358
TOY40MH	134, 138, 142, 164, 168, 174, 178, 182, 186, 198, 200, 224, 228, 346, 350, 358
TOY41RAT4	348, 360
TOY41RAT5	356
TOY41RATE	348, 356, 360
TOY41RFH	64, 348, 352, 356, 360, 364
TOY41RMH	64, 348, 352, 356, 360, 364
TOY41RT4	64, 352, 356
TOY41RTE	64, 352, 356, 364
TOY42AT5	352, 360
TOY43	304, 322
TOY43AT18	332
TOY43AT31	286, 304, 342, 344, 348, 350, 352, 354, 356, 358, 360, 362, 364, 366
TOY43AT4	342, 344, 346, 348, 350, 352, 354, 358, 360, 362, 364, 366
TOY43ATE	286, 304, 342, 344, 348, 350, 352, 354, 356, 358, 360, 362, 364, 366
TOY43FH	286, 304, 342, 344, 346, 348, 350, 352, 354, 356, 358, 360, 362, 364, 366
TOY43MH	286, 304, 342, 344, 346, 348, 350, 352, 354, 356, 358, 360, 362, 364, 366
TOY43P	344, 354
TOY43R	32, 38, 112, 158
TOY43RATE	118, 158
TOY43RFH	32, 38, 112, 118, 158
TOY43RMH	118, 158
TOY43RP	32, 38, 158
TOY43T2	344

Ref.	Page
TOY43T3	346, 354
TOY43TE	344, 346, 354
TOY44	344, 354
TOY46RFH	346
TOY46RMH	346
TOY46RT3	346
TOY46RTE	346
TOY47BP	344
TOY47FH	64, 344, 348, 356
TOY47MH	64, 344, 348, 356
TOY47T16	344
TOY47T4	344, 348, 356
TOY47TE	64, 344, 348, 356
TOY48BT4	198, 200, 350, 358, 360, 362
TOY48BTE	198, 200, 350, 358, 360, 362
TOY48FH	198, 200, 350, 358, 360, 362
TOY48MH	198, 200, 350, 358, 360, 362
TOY49FH	140, 142, 164, 172, 174, 180
TOY49MH	140, 142, 164, 172, 174, 180
TOY49TE	164, 172, 174, 180
TOY57-PT	364
TRK1P	432
TRK2RAP	433
TRK3TBP	433
TRK4CP	433
TRK5P	432
TRK6P	432
TRK7P	432
<b>V</b>	
VA2FH	308
VA2MH	308
VA2T14	54, 56, 272, 274, 280
VA2TE	308



Ref.	Page
VA3-I	282, 298
VA5T5	212
VA6FH	54, 56, 236, 258, 270, 272, 274, 280, 290, 292, 294, 296, 298, 344
VA6MH	54, 56, 236, 258, 270, 272, 274, 280, 290, 292, 294, 296, 298, 344
VAC102-BI	298
VAC102-CI	298
VAC102DP	292
VAC102FH	288, 290, 292, 296, 298, 300
VAC102GP	298
VAC102MH	292, 298, 300
VAC102T1	288, 290, 292, 296, 298
VAC102T32	300
VAC102TE	292, 298, 300
VO11DP	372
VO12	429
VO4RDP	372
<b>W</b>	
WAS2	433
WAS3	433
WAS3BP	433
WAS3RBP	433
WAS4	433
WAS14R	433
WIK1	434
WIK1R	434
WT7CP	372
WT7FP	100
WT9T6	372
<b>Y</b>	
Y160-PT	50, 52, 66, 68, 70, 162, 282,
Y162-PT	50, 52, 66, 68

Ref.	Page
Y164-PT	50, 52, 66, 68, 162, 226, 422
YA4	434
YA4R	434
YA18	434
YAR2	434
YH14	414
YH21R	434
YH29	404, 408
YH29P	404, 408
YH29R	404, 408
YH29RP	404, 408
YH30	404, 406, 408
YH30BP	404, 406, 408
YH30R	404, 406, 408
YH30RBP	404, 406, 408
YH34P	392, 412
YH34RP	392, 412
YH35R	412, 414
YH35RAT22	410, 412, 414
YH35RATE	412, 414
YH35RBP	412, 414
YH35RFH	412, 414
YH35RMH	412, 414
YM15FH	68, 212, 368, 420
YM15P	212, 420
YM15T5	68, 212, 368, 420
YM27T2	28, 122, 252, 258, 264
YM28AT12	28, 114, 250, 262
YM28AT9	26, 114, 116, 250, 254, 260, 262
YM28CP	24
YM28FH	24, 26, 114, 116, 250, 254, 260, 262
YM28T2	24, 26, 114, 116, 250, 254, 260, 262
YM30P	302
YM30T5	302
YW1P	434

Ref.	Page
<b>Z</b>	
ZD16RP	378, 380, 392, 398, 400, 402, 404, 406, 410, 414
ZD17RAP	384, 402
ZD18	435
ZD18R	435
ZD21P	380, 382, 398
ZD22RBP	378
ZD23RCP	392, 398, 402
ZD23RT5	378, 398, 414
ZD24RAT22	414
ZD24RDP	378, 380, 382, 384, 386, 388, 398, 400, 406, 408, 410, 412, 414
ZD24RFH	384, 390, 410, 414
ZD24RMH	390, 410
ZD24RT14	388
ZD24RT5	384, 410, 414
ZD24RTE	390, 410
ZD25	435
ZD28RFP	380
ZD30T5	378, 384, 400
ZD7	400
ZD9	382, 400
ZD9P	382, 400